

Data sheet

Commercial Art.No.: 25.626.3653.0

PCB pin header 8813 S / 6 GF OB

PCB pin header with pin header, connection method depends on used socket part , 6 poles, pitch: 3.81 mm, type of packing: carton, color: grey

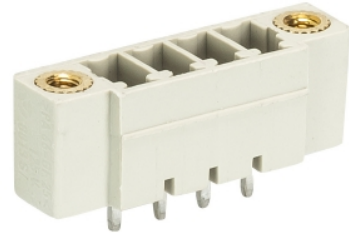

Certificates / Approvals



Technical data

General

Modular spacing	3.81 mm
Soldering process	Wave soldering
Packaging	Carton
Number of poles	6
Number of levels	1
Marking	No
Fastening	Flange
Mating direction towards (circuit) board	90°

Technical data

Rated current	8 A
Overvoltage Category I	690 V
Overvoltage Category II	250 V
Overvoltage Category III	125
Rated impulse voltage	2.5 kV

Technical Data UL/CSA

Voltage UL	300 V
Current field wiring	8 A
Current factory wiring	8 A
Voltage CSA	300 V
Current CSA	5 A

Other

Type of insulation material	Thermoplastic
Color	Grey
Height	9.2 mm
Length	33.25 mm
Depth	7.15 mm
Material contact base	CuZn

Material contact surface	Sn
--------------------------	----

Classification

ECLASS 11	
ECLASS 8.1	27440402
ETIM 7.0	EC002637
ETIM 6.0	EC002637
ETIM 5.0	EC002637
ETIM 4.0	EC002637

Product compliance

ROHS conformity status	Compliant/Exempted
ROHS exceptions	III-6(c)
REACH-SVHC conformity status	Duty-To-Declare
REACH-SVHC substances	Lead
REACH-SVHC CAS numbers	7439-92-1

für folgende Tabellen-Zchnng.:
25.626.3253.0 8813 S/...GF

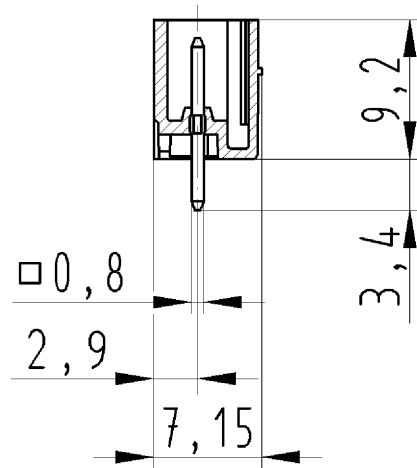
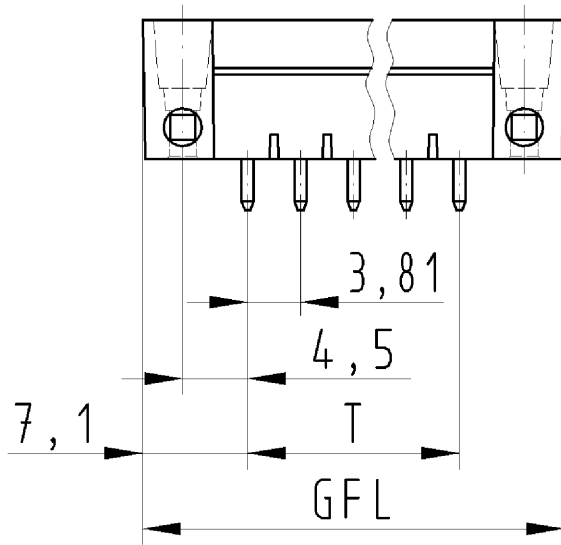

LP-STIFTLLEISTE
25.626.3253.0 10W
24.10.2007 DÜT
M 2:1