

Data sheet

Commercial Art.No.: 25.500.0453.0

Printed circuit board terminal 8134 / 4

PCB terminal with screw connection with rising cage clamp system, 4 poles, printed version, with solder pin (3.5mm), max. cross section: 2.5 mm², pitch: 5 mm, type of packing: carton, color: grey

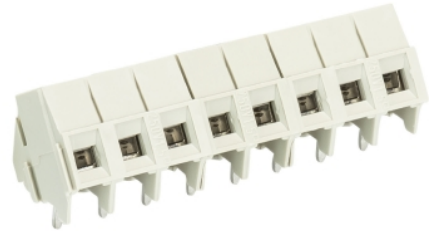

Certificates / Approvals



Technical data

General

Modular spacing	5 mm
Connection type	Screw connection
Soldering process	Wave soldering
Packaging	Carton
Number of poles	4
Conductor to circuit board	35°
Number of levels	1
Integrated test socket	Yes
Insulation plate	No
Retaining pins	No
Marking	Yes

Technical data

Nominal cross section	1.5 mm ²
Rated current	10 A
Overvoltage Category I	1000 V
Overvoltage Category II	690 V
Overvoltage Category III	250 V
Rated impulse voltage	4 kV
Wire strip length	6 mm

Connection Data

Minimum cross section solid	0.14 mm ²
Maximum cross section solid	2.5 mm ²
Minimum cross section fine stranded	0.14 mm ²
Maximum cross section fine stranded	1.5 mm ²
Wire strip length	6 mm

Technical Data UL/CSA

Cross section UL	30-14 AWG
Voltage UL	300 V

Current field wiring	15 A
Current factory wiring	16 A
Cross section CSA	30-14 AWG
Voltage CSA	300 V
Current CSA	15 A

Other

Type of insulation material	Thermoplastic
Color	Grey
Height	11.5 mm
Length	20.55 mm
Depth	11 mm
Material attachment screw	Steel
Material contact base	CuSn
Material contact surface	Sn

Classification

ECLASS 11	
ECLASS 8.1	27440401
ETIM 7.0	EC002643
ETIM 6.0	EC002643
ETIM 5.0	EC002643
ETIM 4.0	EC002643

Product compliance

ROHS conformity status	Compliant/Exempted
ROHS exceptions	III-6(c)
REACH-SVHC conformity status	Duty-To-Declare
REACH-SVHC substances	Lead
REACH-SVHC CAS numbers	7439-92-1

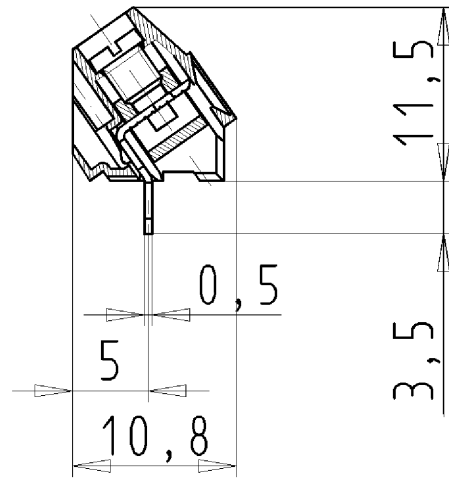
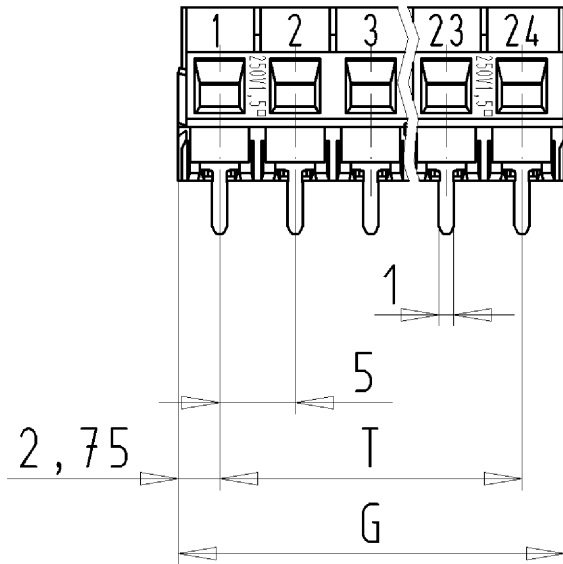

Weitergabe sowie Vervielfältigung dieses Dokuments, Verwertung und Mitteilung seines Inhalts sind verboten, soweit nicht ausdrücklich gestattet. Die reproduction, distribution and utilization of this document as well as the communication of its contents to others without express authorization is prohibited.

für folgende Tabellen-Zchnng.:
 25.500.2453.0 8134/..

LP.KLEMME
 25.500.2453.0 10W
 23.10.2007 TRE
 M 2:1