

## Data sheet

Commercial Art.No.: 25.340.0353.0

PCB connector 8213 B / 3

PCB female connector with screw connection with rising cage clamp system, 3 poles, printed version, max. cross section: 2.5 mm<sup>2</sup>, pitch: 5.08 mm, type of packing: carton, color: grey

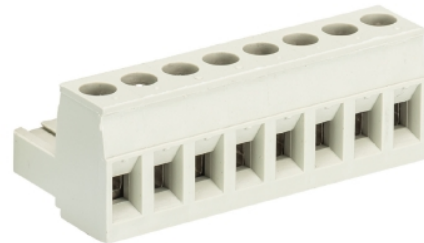

Certificates / Approvals



## Technical data

### General

Modular spacing	5.08 mm
Connection type	Screw connection
Soldering process	None
Packaging	Carton
Number of poles	3
Marking	Yes
Fastening	None
Mating direction towards connector	180°

### Technical data

Nominal cross section	2.5 mm <sup>2</sup>
Rated current	12 A
Overvoltage Category I	1000 V
Overvoltage Category II	400 V
Overvoltage Category III	250 V
Rated impulse voltage	4 kV
Wire strip length	6 mm

### Connection Data

Minimum cross section solid	0.14 mm <sup>2</sup>
Maximum cross section solid	2.5 mm <sup>2</sup>
Minimum cross section fine stranded	0.14 mm <sup>2</sup>
Maximum cross section fine stranded	2.5 mm <sup>2</sup>
Wire strip length	6 mm

### Technical Data UL/CSA

Cross section UL	22-12 AWG
Voltage UL	300 V
Current field wiring	15 A
Current factory wiring	15 A

Cross section CSA	22-12 AWG
Voltage CSA	300 V
Current CSA	15 A

**Other**

Type of insulation material	Thermoplastic
Color	Grey
Height	15 mm
Length	15.24 mm
Depth	18.2 mm
Material attachment screw	CuSn/Steel
Material contact base	CuSn
Material contact surface	Sn

**Classification**

ECLASS 11	
ECLASS 8.1	27440402
ETIM 7.0	EC002637
ETIM 6.0	EC002637
ETIM 5.0	EC002637
ETIM 4.0	EC002637

**Product compliance**

ROHS conformity status	Compliant/Exempted
ROHS exceptions	III-6(c)
REACH-SVHC conformity status	Duty-To-Declare
REACH-SVHC substances	Lead
REACH-SVHC CAS numbers	7439-92-1

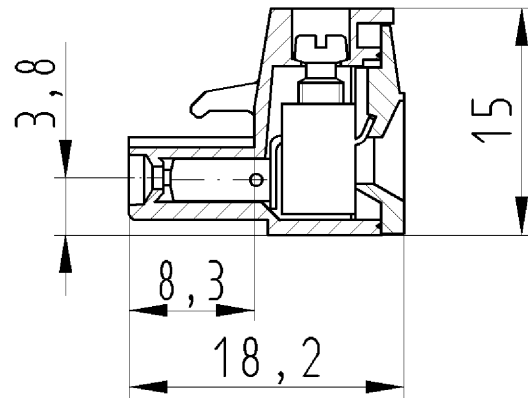
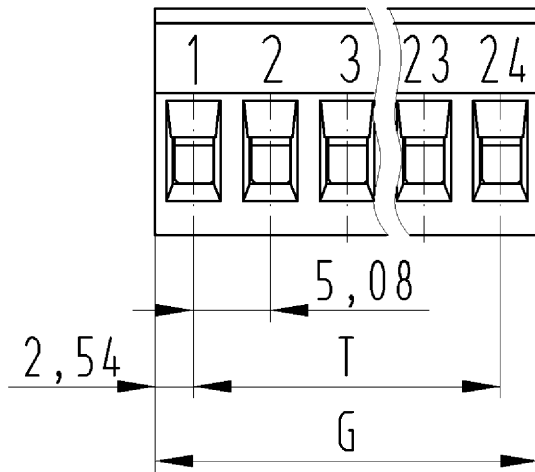

für folgende Tabellen-Zchnng.:  
25.340.0253.0 8213 B/..

LP.KLEMME  
25.340.0253.0 10W  
26.10.2007 DÜT  
M 2:1