

## Data sheet

Commercial Art.No.: 25.190.0653.0

Printed circuit board terminal 8192 / 6

PCB terminal with screw connection with rising cage clamp system, 6 poles, printed version, with solder pin (3.5mm), max. cross section: 2.5 mm<sup>2</sup>, pitch: 5 mm, type of packing: carton, color: grey

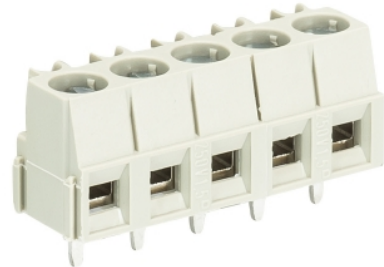

Commercial Art.No.	25.190.0653.0
EAN	4015573178670
Order Unit	50

Certificates / Approvals



## Technical data

### General

Modular spacing	5 mm
Connection type	Screw connection
Soldering process	Wave soldering
Packaging	Carton
Number of poles	6
Conductor to circuit board	180°
Number of levels	1
Integrated test socket	Yes
Insulation plate	No
Retaining pins	No
Marking	Yes

### Technical data

Nominal cross section	1.5 mm <sup>2</sup>
Rated current	10 A
Overvoltage Category I	1000 V
Overvoltage Category II	690 V
Overvoltage Category III	250 V
Rated impulse voltage	4 kV
Wire strip length	6 mm

### Connection Data

Minimum cross section solid	0.14 mm <sup>2</sup>
Maximum cross section solid	2.5 mm <sup>2</sup>
Minimum cross section fine stranded	0.14 mm <sup>2</sup>
Maximum cross section fine stranded	1.5 mm <sup>2</sup>

Wire strip length	6 mm
-------------------	------

**Technical Data UL/CSA**

Cross section UL	30-14 AWG
Voltage UL	300 V
Current field wiring	15 A
Current factory wiring	16 A
Cross section CSA	30-14 AWG
Voltage CSA	300 V
Current CSA	15 A

**Other**

Type of insulation material	Thermoplastic
Color	Grey
Height	10 mm
Length	30.55 mm
Depth	8.2 mm
Material attachment screw	Steel
Material contact base	CuSn
Material contact surface	Sn

**Classification**

ECLASS 11	
ECLASS 8.1	27440401
ETIM 7.0	EC002643
ETIM 6.0	EC002643
ETIM 5.0	EC002643
ETIM 4.0	EC002643

**Product compliance**

ROHS conformity status	Compliant/Exempted
ROHS exceptions	III-6(c)
REACH-SVHC conformity status	Duty-To-Declare
REACH-SVHC substances	Lead
REACH-SVHC CAS numbers	7439-92-1

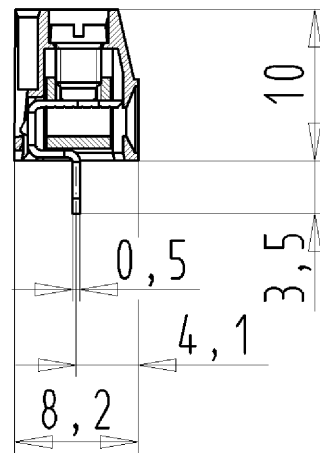
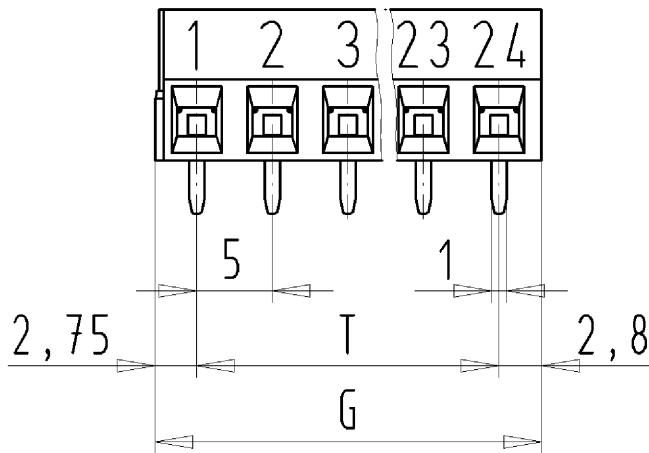

für folgende Tabellen-Zchnng.  
25.190.2453.0 8192/..

LP.KLEMME  
25.190.0253.0 10W  
08.11.2007 DÜT  
M 2:1