

Multilayer Power Inductors



The BKPx Series is a miniature type of multilayer power inductor constructed using low-loss ferrite material to support high-speed switching frequencies. The compact size and high efficiency is ideal for DC-DC converter applications in space-limited boards.

Features

- RoHS, Halogen Free and REACH Compliance
- Small size
- Low profile
- High current
- Magnetically shielded configuration allowing for high density mounting

Applications

- DC-DC converters
- Power modules
- Cellular phones
- DSC, PND, DVD
- Wireless card and other electronic devices

Product Identification

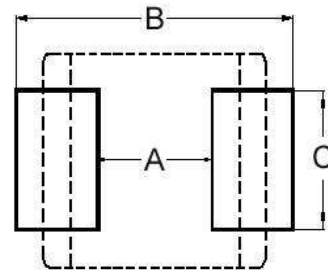
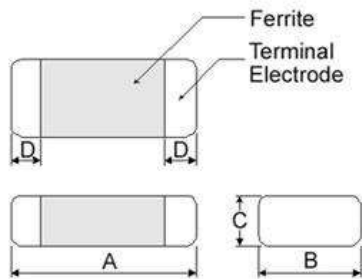
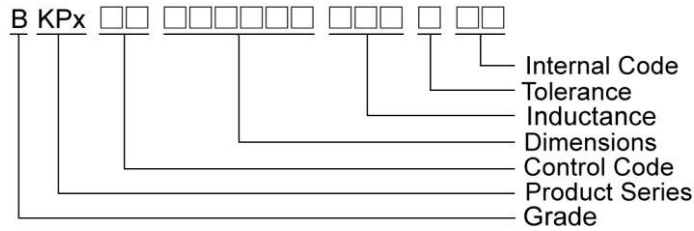

Dimensions in mm

TYPE	A	B	C	D
1608FZ	1.6±0.15	0.8±0.15	0.6±0.15	0.3±0.2
1608DZ	1.6±0.15	0.8±0.15	0.8±0.15	0.3±0.2
201210	2.0±0.20	1.25±0.20	1.0 Max	0.5±0.3
201610	2.0±0.20	1.6±0.20	1.0 Max	0.5±0.3
252010	2.5±0.20	2.0±0.20	1.0 Max	0.6±0.2
252012	2.5±0.20	2.0±0.20	1.2 Max	0.6±0.2

Dimensions in mm

TYPE	A	B	C
1608FZ	0.7 ~ 0.8	1.8 ~ 2.0	0.6 ~ 0.8
1608DZ	0.7 ~ 0.8	1.8 ~ 2.0	0.6 ~ 0.8
201210	0.8 ~ 1.2	2.3 ~ 2.9	1.0 ~ 1.4
201610	0.8 ~ 1.2	2.1 ~ 2.7	1.6 ~ 2.0
252010	1.3 ~ 1.9	2.7 ~ 3.5	2.0 ~ 2.6
252012	1.3 ~ 1.9	2.7 ~ 3.5	2.0 ~ 2.6

SMD Multilayer Power Inductors – BKPA/BKPB/BKPE Series

Electrical Characteristics

Part Number	Inductance (μH)	Tolerance ($\pm\%$)	Test Frequency (MHz)	RDC (Ω) $\pm 30\%$	Rated current (mA) Max
BKPA002012101R0□00	1.0	20, 30	1	0.18	1100
BKPA002012101R5□00	1.5	20, 30	1	0.19	1000
BKPA002012102R2□00	2.2	20, 30	1	0.22	900
BKPA002012103R3□00	3.3	20, 30	1	0.25	700
BKPA002012104R7□00	4.7	20, 30	1	0.35	600

Note: When ordering, please specify tolerance code. Tolerance: M= $\pm 20\%$, T= $\pm 30\%$

- Operating temperature range - 55°C ~ 125°C(Including self - temperature rise)
- Rated Current for a 40°C temperature rise from 25°C ambient with current
- Measure Equipment :
L : Agilent HP4287A+16197A, 1MHz 200mV
RDC : HP 4338B, or equivalent

Test Instruments : HP4287A Inductance / Material Analyzer

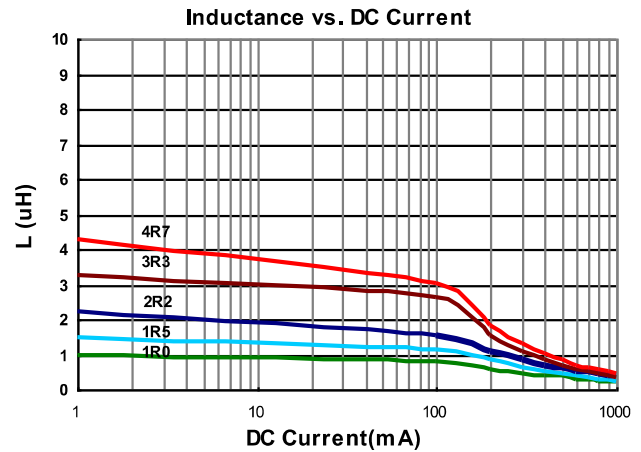
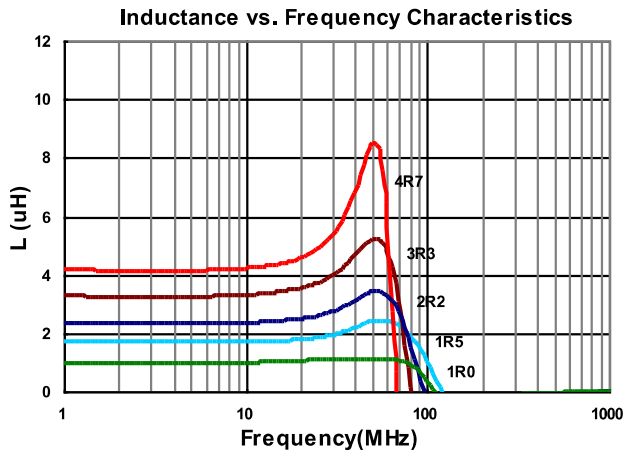

SMD Multilayer Power Inductors –BKPA/BKPB/BKPE Series

Electrical Characteristics

Part Number	Inductance (μH)	Tolerance ($\pm\%$)	Test Frequency (MHz)	RDC (Ω) $\pm 30\%$	Rated current (mA) Max
BKPA002520101R0□00	1.0	20, 30	1	0.11	1200
BKPA002520101R5□00	1.5	20, 30	1	0.13	1100
BKPA002520102R2□00	2.2	20, 30	1	0.15	1000
BKPA002520103R3□00	3.3	20, 30	1	0.18	1000
BKPA002520104R7□00	4.7	20, 30	1	0.25	900

Note: When ordering, please specify tolerance code. Tolerance: M= $\pm 20\%$, T= $\pm 30\%$

- Operating temperature range - 55°C ~ 125°C(Including self - temperature rise)
- Rated Current for a 40°C temperature rise from 25°C ambient with current
- Measure Equipment :
L : Agilent HP4287A+16197A, 1MHz 200mV
RDC : HP 4338B, or equivalent

Test Instruments : HP4287A Inductance / Material Analyzer

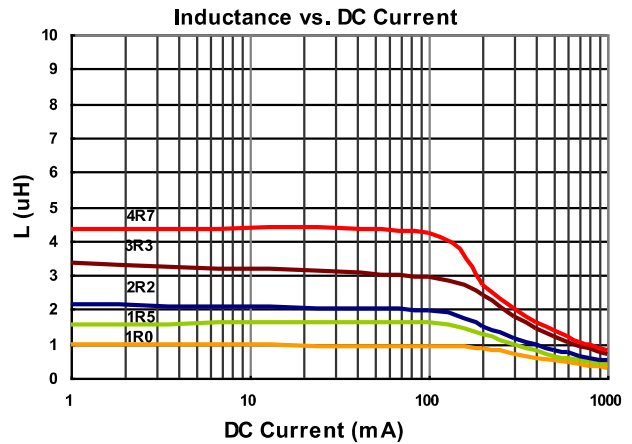
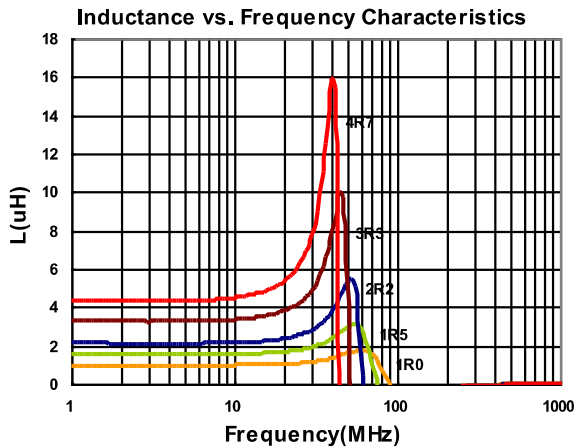

SMD Multilayer Power Inductors –BKPA/BKPB/BKPE Series

Electrical Characteristics

Part Number	Inductance (μH)	Tolerance ($\pm\%$)	Test Frequency (MHz)	RDC (Ω) $\pm 30\%$	Isat (mA) Max	Irms (mA) Max
BKPB001608DZR47□A2	0.47	20, 30	3	0.15	400	1100
BKPB001608DZ1R0□A2	1.0	20, 30	3	0.20	200	950
BKPB001608DZ2R2□A2	2.2	20, 30	3	0.30	150	750
BKPB001608DZ4R7□A6	4.7	20	3	0.44 $\pm 25\%$	80	800

Note: When ordering, please specify tolerance code. Tolerance: M=±20% , T=±30%

- Operating temperature range - 55°C ~ 125°C(Including self - temperature rise)
- Isat for Inductance drop 30% from its value without current
- I rms for a 40°C temperature rise from 25°C ambient with current
- Measure Equipment :
L : Agilent HP4287A+16197A, 3MHz 200mV
RDC : HP 4338B, or equivalent

Test Instruments : HP4287A Inductance / Material Analyzer

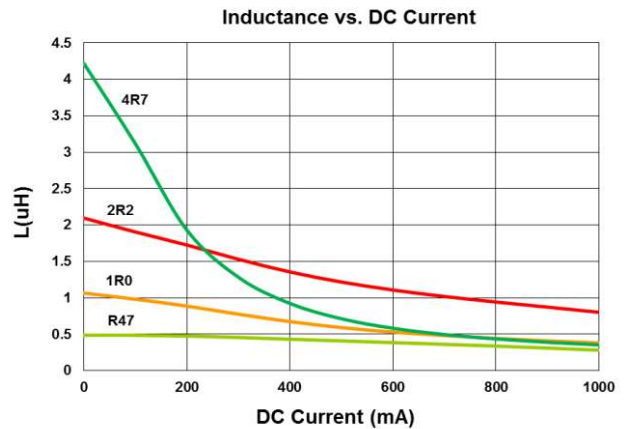
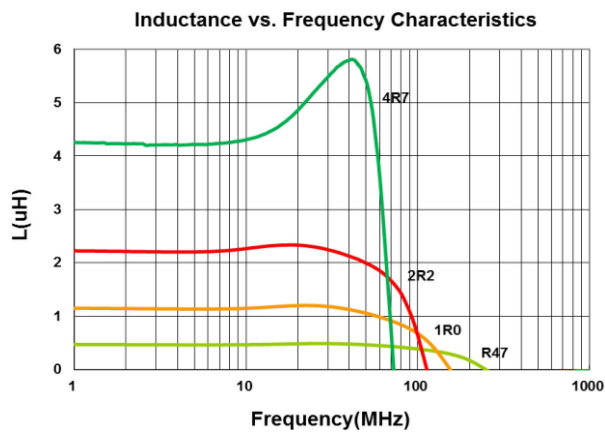

SMD Multilayer Power Inductors –BKPA/BKPB/BKPE Series

Electrical Characteristics

Part Number	Inductance (μH)	Tolerance ($\pm\%$)	Test Frequency (MHz)	RDC (Ω) $\pm 30\%$	Isat (mA) Max	Irms (mA) Max
BKPB00201210R47□A2	0.47	20, 30	3	0.09	1100	1300
BKPB002012101R0□A2	1.0	20, 30	3	0.12	650	1200
BKPB002012101R5□A2	1.5	20, 30	3	0.15	450	1100
BKPB002012102R2□A2	2.2	20, 30	3	0.19	400	1100
BKPB002012102R7□A2	2.7	20, 30	3	0.21	300	1000
BKPB002012103R3□A2	3.3	20, 30	3	0.24	300	800
BKPB002012104R7□A2	4.7	20, 30	3	0.26	200	700

Note: When ordering, please specify tolerance code. Tolerance: M=±20% , T=±30%

- Operating temperature range - 55°C ~ 125°C(Including self - temperature rise)
- Isat for Inductance drop 30% from its value without current
- Irms for a 40°C temperature rise from 25°C ambient with current
- Measure Equipment :
L : Agilent HP4287A+16197A, 3MHz 200mV
RDC : HP 4338B, or equivalent

Test Instruments : HP4287A Inductance / Material Analyzer

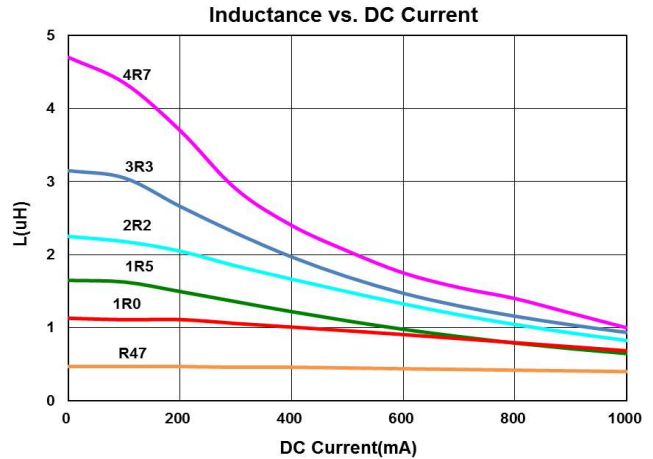
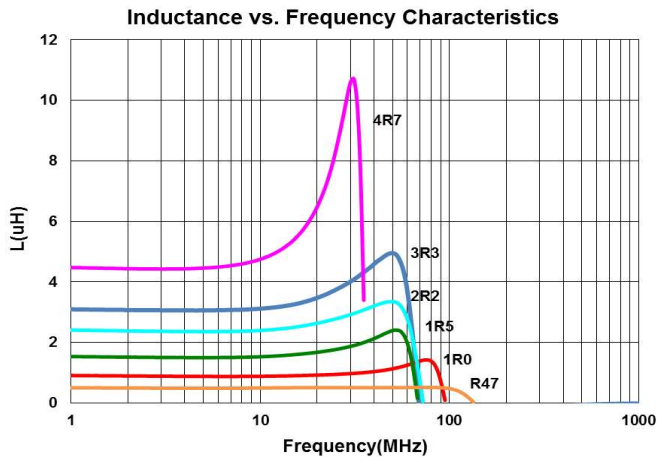

SMD Multilayer Power Inductors –BKPA/BKPB/BKPE Series

Electrical Characteristics

Part Number	Inductance (μH)	Tolerance ($\pm\%$)	Test Frequency (MHz)	RDC (Ω)	Isat (mA) Max	Irms (mA) Max
BKPB00201610R47□A2	0.47	20, 30	3	0.06 \pm 30%	1200	1600
BKPB002016101R0□A2	1.0	20, 30	3	0.09 \pm 30%	850	1300
BKPB002016102R2□A2	2.2	20, 30	3	0.13 \pm 30%	400	1000
BKPB002016103R3□A2	3.3	20, 30	3	0.17 \pm 30%	350	850
BKPB002016104R7□A2	4.7	20, 30	3	0.21 \pm 30%	200	800
BKPB00201610R47□A6	0.47	20, 30	3	0.06 \pm 25%	1200	1600
BKPB002016101R0□A6	1.0	20, 30	3	0.085 \pm 25%	850	1300
BKPB002016101R5□A6	1.5	20, 30	3	0.11 \pm 25%	600	1200
BKPB002016102R2□A6	2.2	20, 30	3	0.11 \pm 25%	400	1200
BKPB002016103R3□A6	3.3	20, 30	3	0.12 \pm 25%	350	850
BKPB002016104R7□A6	4.7	20, 30	3	0.14 \pm 25%	200	1100

Note: When ordering, please specify tolerance code. Tolerance: M= \pm 20% , T= \pm 30%

- Operating temperature range - 55°C ~ 125°C(Including self - temperature rise)
- Isat for Inductance drop 30% from its value without current
- I rms for a 40°C temperature rise from 25°C ambient with current
- Measure Equipment :
L : Agilent HP4287A+16197A, 3MHz 200mV
RDC : HP 4338B, or equivalent

Test Instruments : HP4287A Inductance / Material Analyzer

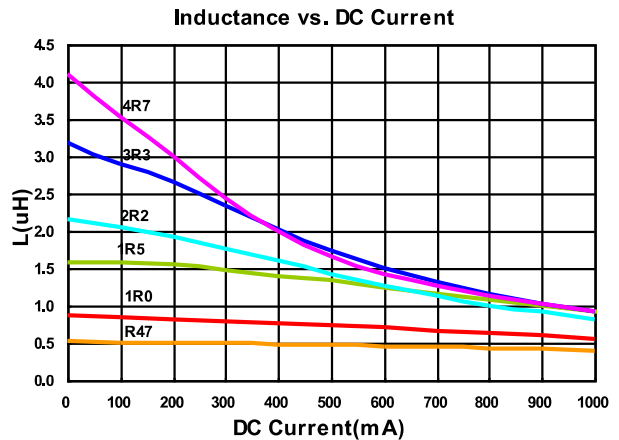
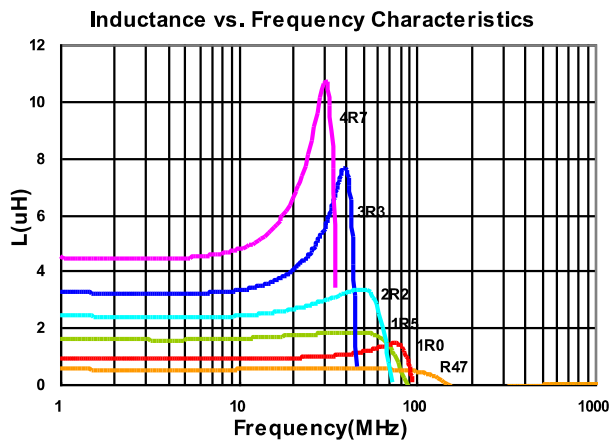

SMD Multilayer Power Inductors –BKPA/BKPB/BKPE Series

Electrical Characteristics

Part Number	Inductance (μH)	Tolerance ($\pm\%$)	Test Frequency (MHz)	RDC (Ω)	Isat (mA) Max	Irms (mA) Max
BKPB00252010R47□A2	0.47	20, 30	3	0.04 \pm 30%	1500	1800
BKPB002520101R0□A2	1.0	20, 30	3	0.06 \pm 30%	900	1500
BKPB002520101R5□A2	1.5	20, 30	3	0.07 \pm 30%	800	1400
BKPB002520102R2□A2	2.2	20, 30	3	0.10 \pm 30%	500	1200
BKPB002520103R3□A2	3.3	20, 30	3	0.12 \pm 30%	400	1100
BKPB002520104R7□A2	4.7	20, 30	3	0.14 \pm 30%	300	1000
BKPB00252010R47□A6	0.47	20, 30	3	0.04 \pm 25%	1500	1800
BKPB002520101R0□A6	1.0	20, 30	3	0.055 \pm 25%	900	1600
BKPB002520102R2□A6	2.2	20, 30	3	0.08 \pm 25%	500	1300
BKPB002520103R3□A6	3.3	20, 30	3	0.10 \pm 25%	400	1200
BKPB002520104R7□A6	4.7	20, 30	3	0.11 \pm 25%	300	1100

Note: When ordering, please specify tolerance code. Tolerance: M= \pm 20% , T= \pm 30%

- Operating temperature range - 55°C ~ 125°C(Including self - temperature rise)
- Isat for Inductance drop 30% from its value without current
- I rms for a 40°C temperature rise from 25°C ambient with current
- Measure Equipment :
L : Agilent HP4287A+16197A, 3MHz 200mV
RDC : HP 4338B, or equivalent

Test Instruments : HP4287A Inductance / Material Analyzer

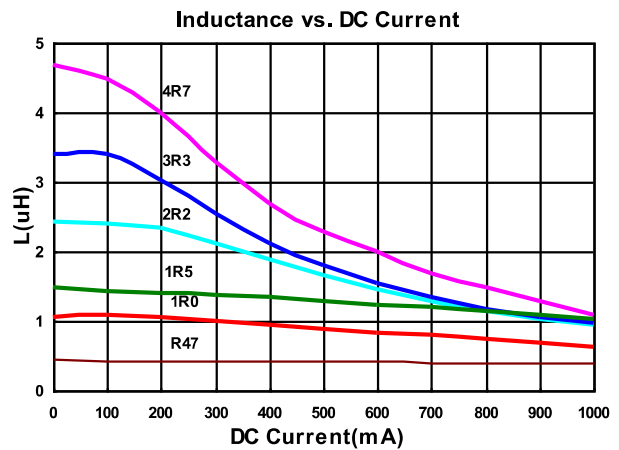
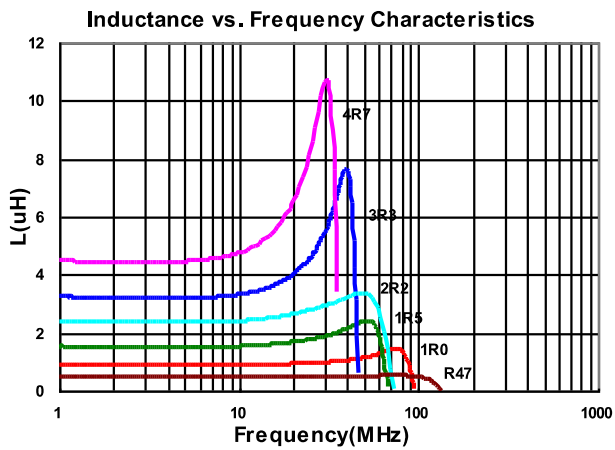

SMD Multilayer Power Inductors –BKPA/BKPB/BKPE Series

Electrical Characteristics

Part Number	Inductance (μH)	Tolerance ($\pm\%$)	Test Frequency (MHz)	RDC (Ω) $\pm 30\%$	Isat (mA) Max	Irms (mA) Max
BKPB00252012R47□A2	0.47	20, 30	3	0.04	1500	1800
BKPB002520121R0□A2	1.0	20, 30	3	0.05	950	1600
BKPB002520121R5□A2	1.5	20, 30	3	0.07	900	1400
BKPB002520122R2□A2	2.2	20, 30	3	0.10	700	1200
BKPB002520123R3□A2	3.3	20, 30	3	0.12	500	1100
BKPB002520124R7□A2	4.7	20, 30	3	0.14	350	1000

Note: When ordering, please specify tolerance code. Tolerance: M= $\pm 20\%$, T= $\pm 30\%$

- Operating temperature range - 55°C ~ 125°C(Including self - temperature rise)
- Isat for Inductance drop 30% from its value without current
- I rms for a 40°C temperature rise from 25°C ambient with current
- Measure Equipment :

L : Agilent HP4287A+16197A, 3MHz 200mV

RDC : HP 4338B, or equivalent

Test Instruments : HP4287A Inductance / Material Analyzer

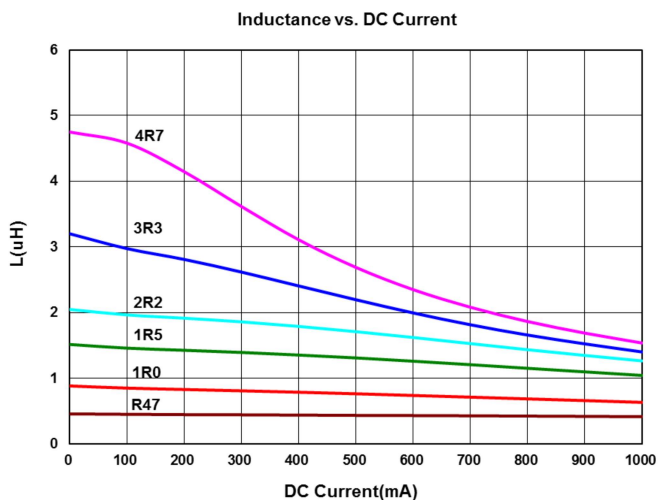
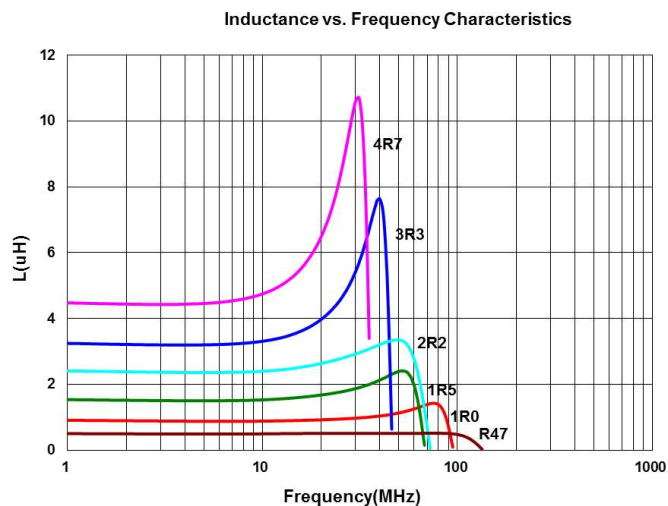

SMD Multilayer Power Inductors –BKPA/BKPB/BKPE Series

Electrical Characteristics

Part Number	Inductance (μH)	Tolerance ($\pm\%$)	Test Frequency (MHz)	RDC (Ω) $\pm 25\%$	Isat(mA) Max(Typ.)	Irms(mA) Max(Typ.)
BKPE001608FZ2R2□A6	2.2	20, 30	3	0.38	250(300)	650(750)

Note: When ordering, please specify tolerance code. Tolerance: M= $\pm 20\%$, T= $\pm 30\%$

- Operating temperature range - 55°C ~ 125°C(Including self - temperature rise)
- Isat for Inductance drop 30% from its value without current
- Irms for a 40°C temperature rise from 25°C ambient with current
- Measure Equipment :
 - L : Agilent HP4287A+16197A, 3MHz 200mV
 - RDC : HP 4338B, or equivalent

Test Instruments : HP4287A Inductance / Material Analyzer

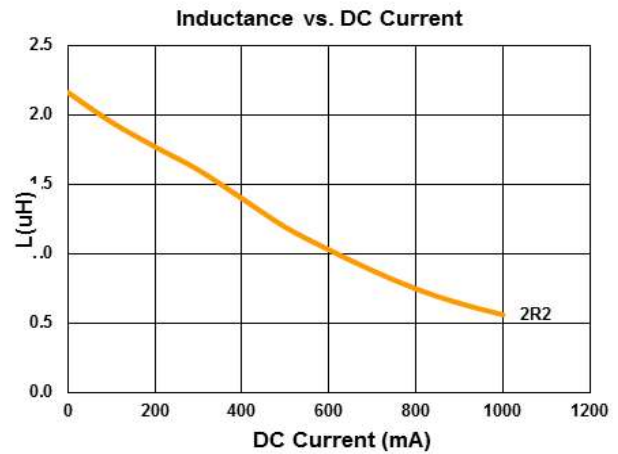
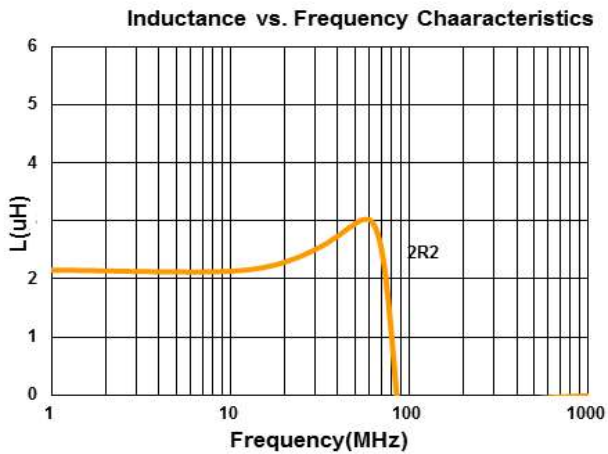

SMD Multilayer Power Inductors –BKPA/BKPB/BKPE Series

Electrical Characteristics

Part Number	Inductance (μH)	Tolerance ($\pm\%$)	Test Frequency (MHz)	RDC (Ω) $\pm 25\%$	Isat(mA) Max(Typ.)	Irms(mA) Max(Typ.)
BKPE001608DZ1R0□A6	1.0	20, 30	3	0.13	500(650)	1300(1450)
BKPE001608DZ2R2□A6	2.2	20, 30	3	0.38	300(350)	700(900)

Note: When ordering, please specify tolerance code. Tolerance: M=±20% , T=±30%

- Operating temperature range - 55°C ~ 125°C(Including self - temperature rise)
- Isat for Inductance drop 30% from its value without current
- Irms for a 40°C temperature rise from 25°C ambient with current
- Measure Equipment :
L : Agilent HP4287A+16197A, 3MHz 200mV
RDC : HP 4338B, or equivalent

Test Instruments : HP4287A Inductance / Material Analyzer

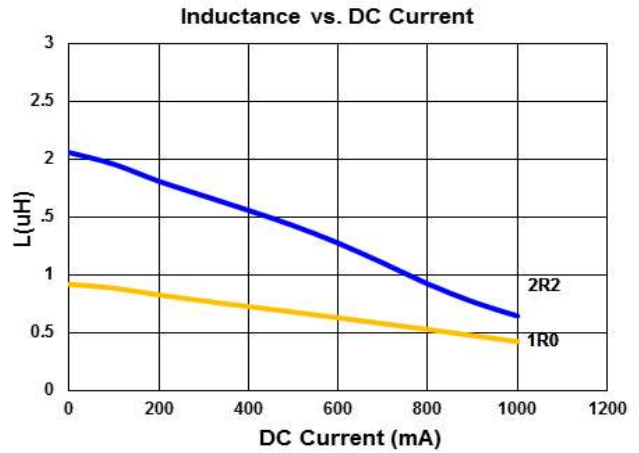
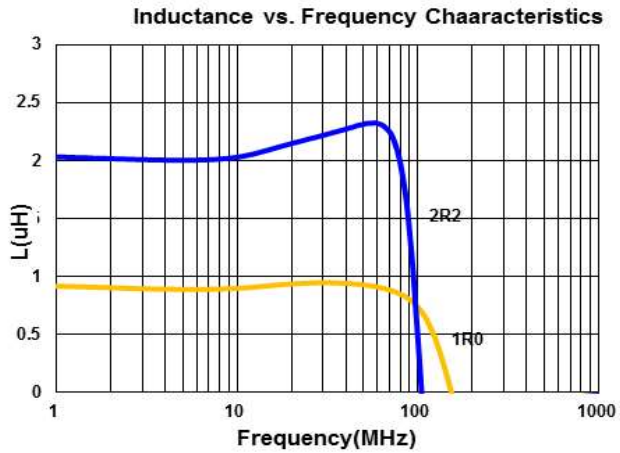

SMD Multilayer Power Inductors –BKPA/BKPB/BKPE Series

Electrical Characteristics

Part Number	Inductance (μH)	Tolerance ($\pm\%$)	Test Frequency (MHz)	RDC (Ω) $\pm 25\%$	Isat(mA) Max(Typ.)	Irms(mA) Max(Typ.)
BKPE00201210R24□A2	0.24	20, 30	3	0.03	2700(3300)	2400(3200)
BKPE00201210R47□A2	0.47	20, 30	3	0.06	1600(2000)	2200(3000)
BKPE002012101R0□A2	1.0	20, 30	3	0.10	1400(1700)	1800(2100)
BKPE002012102R2□A2	2.2	20, 30	3	0.125	500(800)	1600(1900)

Note: When ordering, please specify tolerance code. Tolerance: M= $\pm 20\%$, T= $\pm 30\%$

- Operating temperature range - 55°C ~ 125°C(Including self - temperature rise)
- Isat for Inductance drop 30% from its value without current
- Irms for a 40°C temperature rise from 25°C ambient with current
- Measure Equipment :
L : Agilent HP4287A+16197A, 3MHz 200mV
RDC : HP 4338B, or equivalent

Test Instruments : HP4287A Inductance / Material Analyzer

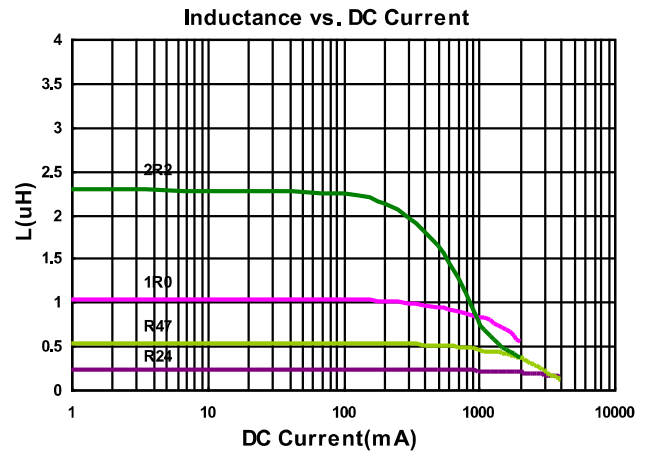
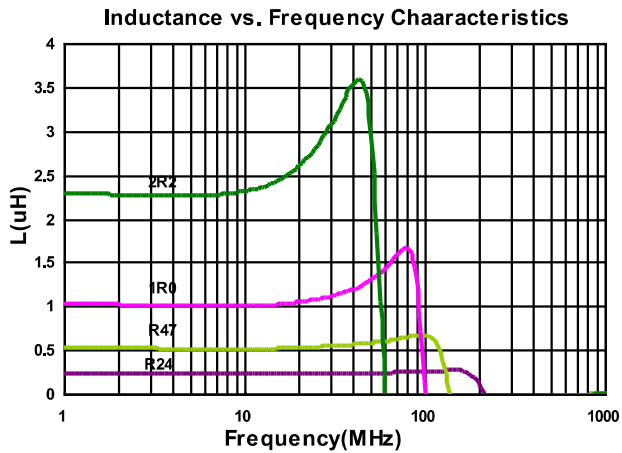

SMD Multilayer Power Inductors – BKPA/BKPB/BKPE Series

Electrical Characteristics

Part Number	Inductance (μH)	Tolerance ($\pm\%$)	Test Frequency (MHz)	RDC (Ω) $\pm 25\%$	Isat(mA) Max(Typ.)	Irms(mA) Max(Typ.)
BKPE00201610R24□A2	0.24	20, 30	3	0.023	3600(4000)	3500(4200)
BKPE00201610R47□A2	0.47	20, 30	3	0.037	2500(2900)	2600(3100)
BKPE00201610R68□A2	0.68	20, 30	3	0.065	2500(2800)	2400(2800)
BKPE002016101R0□A2	1.0	20, 30	3	0.068	1500(1900)	2200(2600)
BKPE002016101R5□A2	1.5	20, 30	3	0.100	1500(1800)	1600(1900)
BKPE002016102R2□A2	2.2	20, 30	3	0.210	1000(1300)	1500(1800)

Note: When ordering, please specify tolerance code. Tolerance: M= $\pm 20\%$, T= $\pm 30\%$

- Operating temperature range - 55°C ~ 125°C(Including self - temperature rise)
- Isat for Inductance drop 30% from its value without current
- Irms for a 40°C temperature rise from 25°C ambient with current
- Measure Equipment :
L : Agilent HP4287A+16197A, 3MHz 200mV
RDC : HP 4338B, or equivalent

Test Instruments : HP4287A Inductance / Material Analyzer

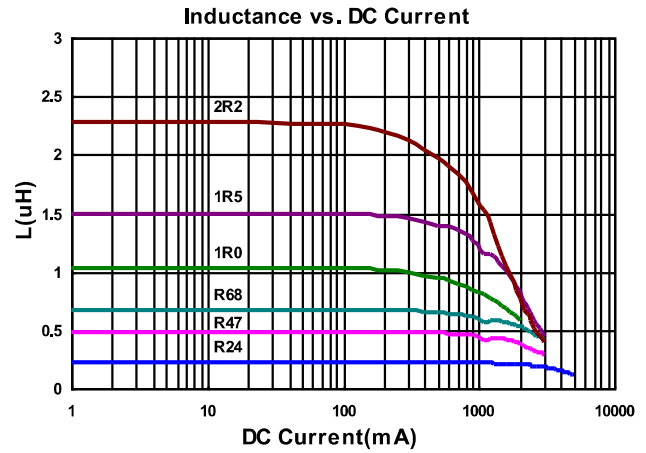
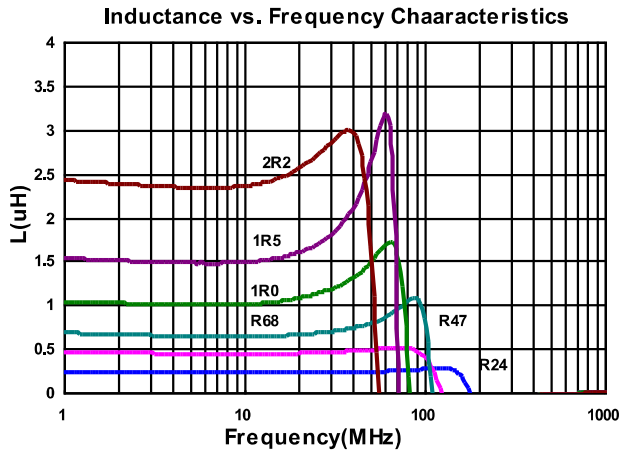

SMD Multilayer Power Inductors – BKPA/BKPB/BKPE Series

Electrical Characteristics

Part Number	Inductance (μH)	Tolerance ($\pm\%$)	Test Frequency (MHz)	RDC (Ω) $\pm 25\%$	Isat(mA) Max(Typ.)	Irms(mA) Max(Typ.)
BKPE00252010R24□A2	0.24	20, 30	3	0.024	4800(5200)	4100(4900)
BKPE00252010R47□A2	0.47	20, 30	3	0.040	3100(3500)	3000(3600)
BKPE002520101R0□A2	1.0	20, 30	3	0.050	1500(1900)	2900(3500)
BKPE002520102R2□A2	2.2	20, 30	3	0.110	1400(1700)	1600(1900)

Note: When ordering, please specify tolerance code. Tolerance: M= $\pm 20\%$, T= $\pm 30\%$

- Operating temperature range - 55°C ~ 125°C(Including self - temperature rise)
- Isat for Inductance drop 30% from its value without current
- I rms for a 40°C temperature rise from 25°C ambient with current
- Measure Equipment :
L : Agilent HP4287A+16197A, 3MHz 200mV
RDC : HP 4338B, or equivalent

Test Instruments : HP4287A Inductance / Material Analyzer

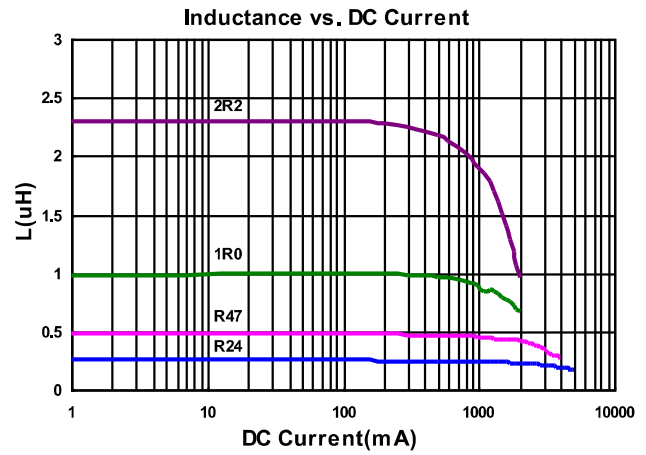
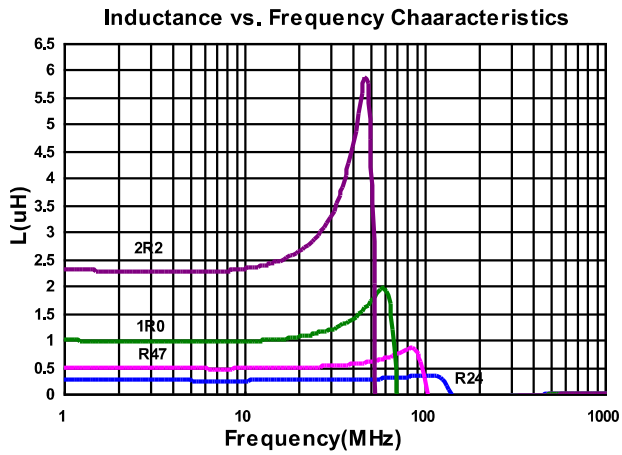

SMD Multilayer Power Inductors –BKPA/BKPB/BKPE Series

Packaging Specifications

Tape Dimensions

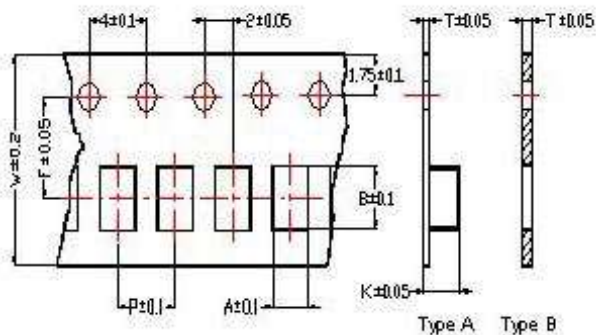

Tape Material

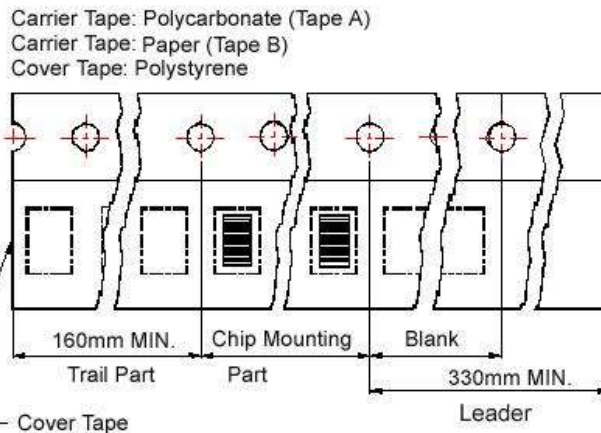

Reel Dimensions

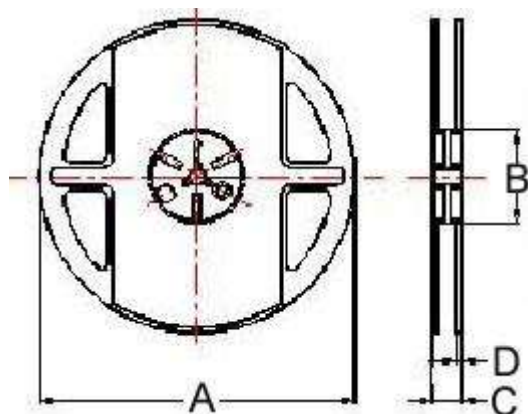

Dimensions in mm

TYPE	Tape Dimensions								Reel Dimensions				Quantity
	A	B	T	W	P	F	K	Tape Type	A	B	C	D	PCS / REEL
1608FZ	1.05	1.85	0.75	8.0	4.0	3.5	-	B	178	60	12	1.5	4000
1608DZ	1.05	1.85	0.95	8.0	4.0	3.5	-	B	178	60	12	1.5	4000
201210	1.45	2.25	0.22	8.0	4.0	3.5	1.04	A	178	60	12	1.5	3000
201610	1.80	2.20	0.22	8.0	4.0	3.5	1.15	A	178	60	12	1.5	3000
252010	2.25	2.8	0.25	8.0	4.0	3.5	1.35	A	178	60	12	1.5	3000
252012	2.25	2.8	0.25	8.0	4.0	3.5	1.35	A	178	60	12	1.5	3000

Multilayer Power Inductors



The BKPB Series is a miniature type of multilayer power inductor constructed using low-loss ferrite material to support high-speed switching frequencies. The compact size and high efficiency is ideal for DC-DC converter applications in space-limited boards.

Features

- For High Frequency SW (15MHz to 200MHz)
- Bias Current Characteristics improved.
- Low Power loss
- High DC Bias
- High Current
- Low ACR

Applications

- High Frequency DC/DC converter.

Product Identification

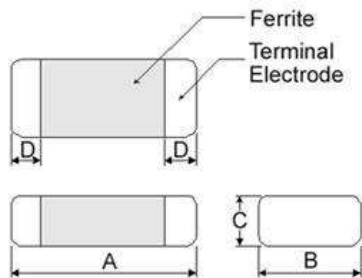
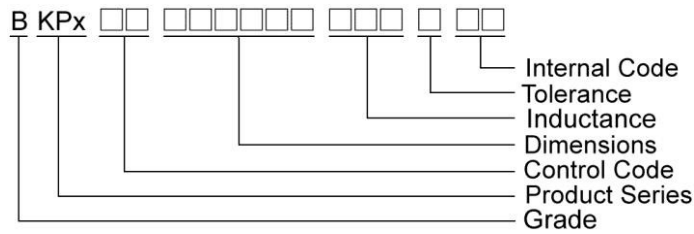

Dimensions in mm

TYPE	A	B	C	D
2012C5	2.0±0.20	1.25±0.20	0.95 Max	0.5±0.3

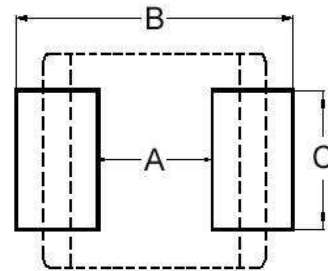

Dimensions in mm

TYPE	A	B	C
2012C5	0.8 ~ 1.2	2.3 ~ 2.9	1.0 ~ 1.4

SMD Multilayer Power Inductors – BKPB Series

Electrical Characteristics

Part Number	Inductance (μH)	Tolerance ($\pm\%$)	Test Frequency (MHz)	RDC (Ω) $\pm 30\%$	Isat (mA) Max	Irms (mA) Max
BKPB002012C522N□A2	0.022	10, 20	50	0.044	3000	2000
BKPB002012C533N□A2	0.033	10, 20	50	0.050	2700	1800
BKPB002012C547N□A2	0.047	10, 20	50	0.058	2400	1600

Note: When ordering, please specify tolerance code. Tolerance: K= $\pm 10\%$, M= $\pm 20\%$

- Operating temperature range - 55°C ~ 125°C(Including self - temperature rise)
- Isat for Inductance drop 30% from its value without current
- I rms for a 40°C temperature rise from 25°C ambient with current
- Measure Equipment :
 L : Agilent E4991A+16197A, 50MHz 200mV
 RDC : HP 4338B, or equivalent

Test Instruments : E4991A Inductance / Material Analyzer

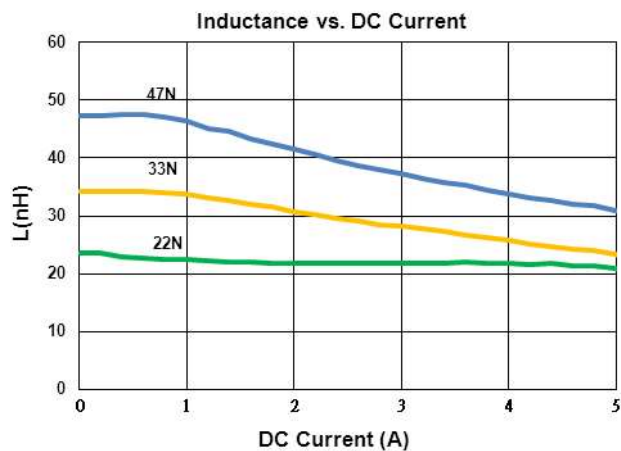
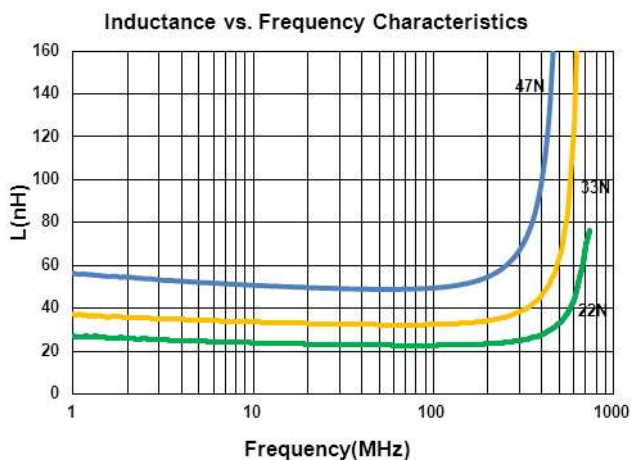

SMD Multilayer Power Inductors – BKPB Series

Packaging Specifications

Tape Dimensions

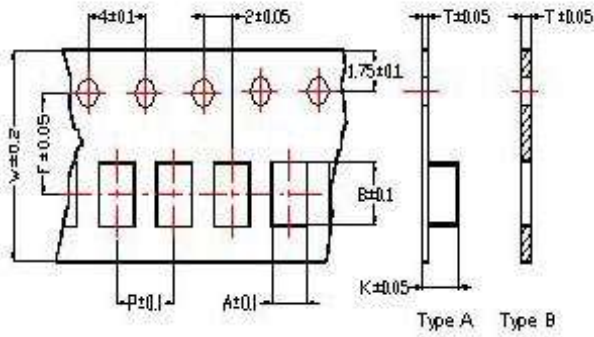

Tape Material

Carrier Tape: Polycarbonate (Tape A)
 Carrier Tape: Paper (Tape B)
 Cover Tape: Polystyrene

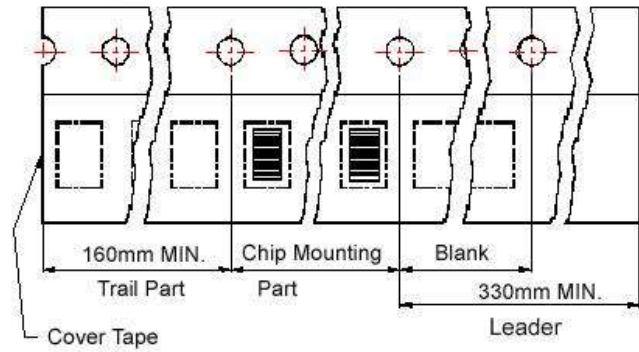

Reel Dimensions

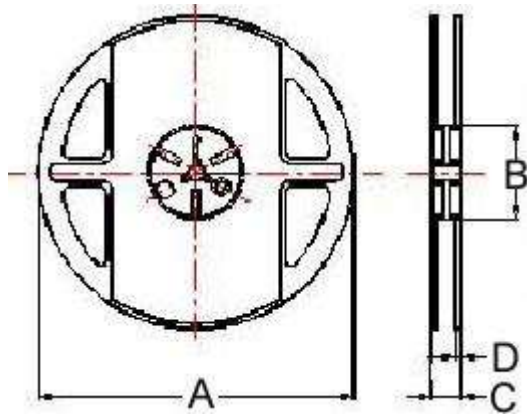

Dimensions in mm

TYPE	Tape Dimensions								Reel Dimensions				Quantity
	A	B	T	W	P	F	K	Tape Type	A	B	C	D	PCS / REEL
2012C5	1.45	2.25	0.22	8.0	4.0	3.5	1.04	A	178	60	12	1.5	3000