

Current Sensor TLI4971 / TLE4971

120A three-phase measurement board



About this document

- TLI4971 EVAL 120A / TLE4971 EVAL 120A board description (Three-Phase Current Sensor board)
- Thermal behavior
- High Voltage disclaimer and safety precaution

Scope and purpose

Describing the setup and behavior of the three-phase evaluation board

Intended audience

Users who are intending to use magnetic current sensors for high voltage applications.

Table of contents

About this document	1
Table of contents	1
1 Introduction	2
1.1 Three Phase Evaluation Board.....	2
1.2 Order Information	2
2 Board description	3
2.1 Layer Stack	4
2.2 Pin description	5
3 Thermal performance	6
3.1 Thermal evaluation	6
3.2 Thermal behavior comparison	9
4 Disclaimer	11

1 Introduction

1.1 Three Phase Evaluation Board

- The TLI4971 EVAL 120A / TLE4971 EVAL 120A board is a three-phase measurement board developed for design in support and evaluation purpose.
- To connect the sensor PCB with the generic Infineon evaluation board (CUR SENSOR PROGRAMMER) a connector is installed on the measurement board.
- A detailed description of the generic programmer board and the interface GUI is described in the “Programmer User Manual” Application note.
- For better readability and better overview on documentation on Infineon web page this document combines the 3-phase evaluation board of TLI4971 and TLE4971. In the case only “TLI4971” is mentioned for a specific measurement or property it is also valid for TLE4971 as well.
- Using this link you may find the software package for the related XENSIV™ TLx4971 - TLE4972 Current Sensor Programmer interfacing the Three Phase Evaluation Board:
<https://softwaretools.infineon.com/tools/com.ifx.tb.tool.xensivcurrentsensorevaluationsoftware>
- Please be also aware further technical data to this board is available on www.infineon.com in section “myInfineon”. Please register your new Three Phase Evaluation Board!

1.2 Order Information

Table 1 Order Information

Product Name	Description	Ordering Number
TLI4971 EVAL 120A	Three-Phase Current Sensor Measurement Board	SP005343588
TLE4971 EVAL 120A	Three-Phase Current Sensor Measurement Board	SP005876845
CUR SENSOR PROGRAMMER	Generic Interface and Programmer Board	SP004441438

2 Board description

- The TLI4971 EVAL 120A / TLE4971 EVAL 120A is a three-phase current sensor board equipped with TLI4971 or TLE4971 current sensor.
- The current rail distance is 8.7mm in order to meet the 4mm clearance/creepage distance between the high voltage current rails and the low voltage signal pins.
- The PCB is equipped with an EEPROM in order to store for each board individual settings and ID.
- A connector is installed to supply and interface the sensor.

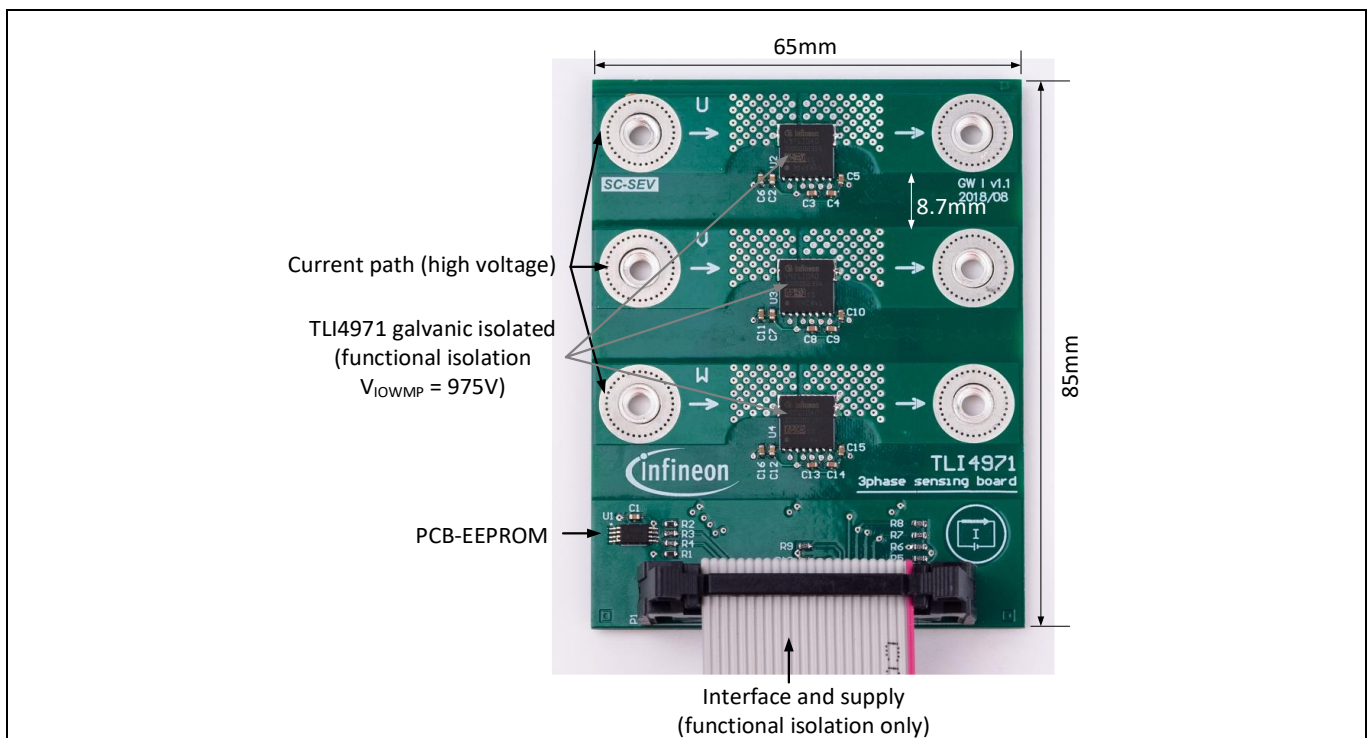

Figure 1 TLI4971 EVAL 120A, three phase measurement board

2.1 Layer Stack

- The TLI4971 EVAL 120A / TLE4971 EVAL 120A board consist of four layer described in the below Figure 2.
- The two outer layer consists of 140µm metallization.
- The inner layer consist of 35µm metallization.
- Table 2 gives an detailed description of the board setup

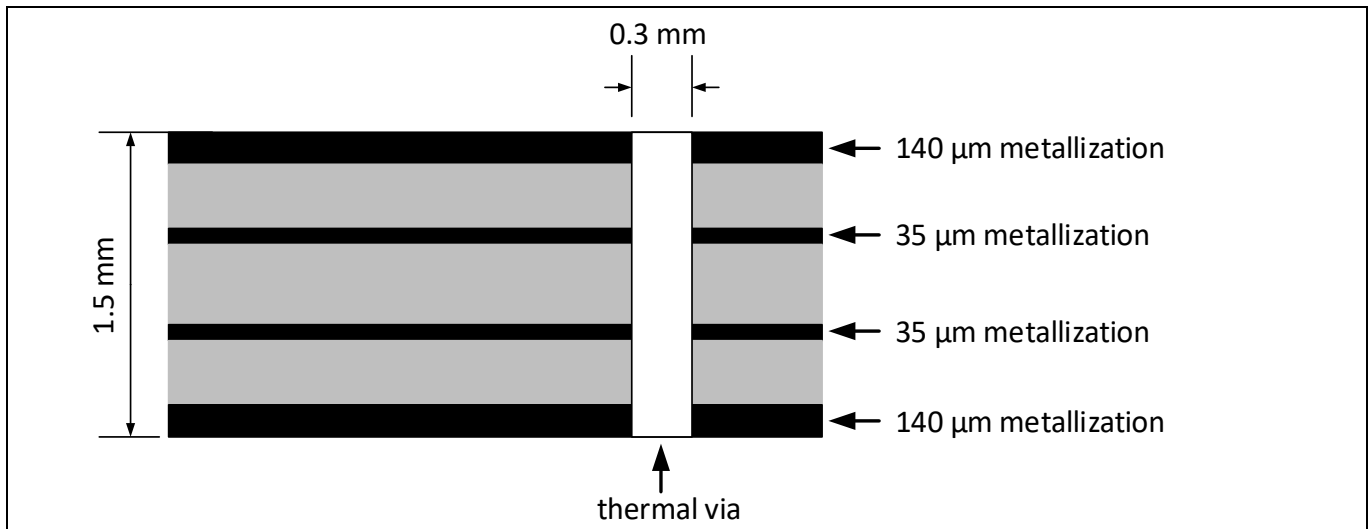

Figure 2 Reference board layer stack

Table 2 Single-phase reference board specification

Position	Description
Board dimension	65mm x 85mm x 1.5mm
PCB Material	FR4
Copper metallization	4 layers 140/35/35/140 µm
Thermal Vias	Ø = 0.3 mm;
Package Attach [50µm]	solder
Surface finish	Board with mounted TLI4971: HASL
	Board with mounted TLE4971: ENIG

2.2 Pin description

Figure 3 shows the header detail of the measurement board.

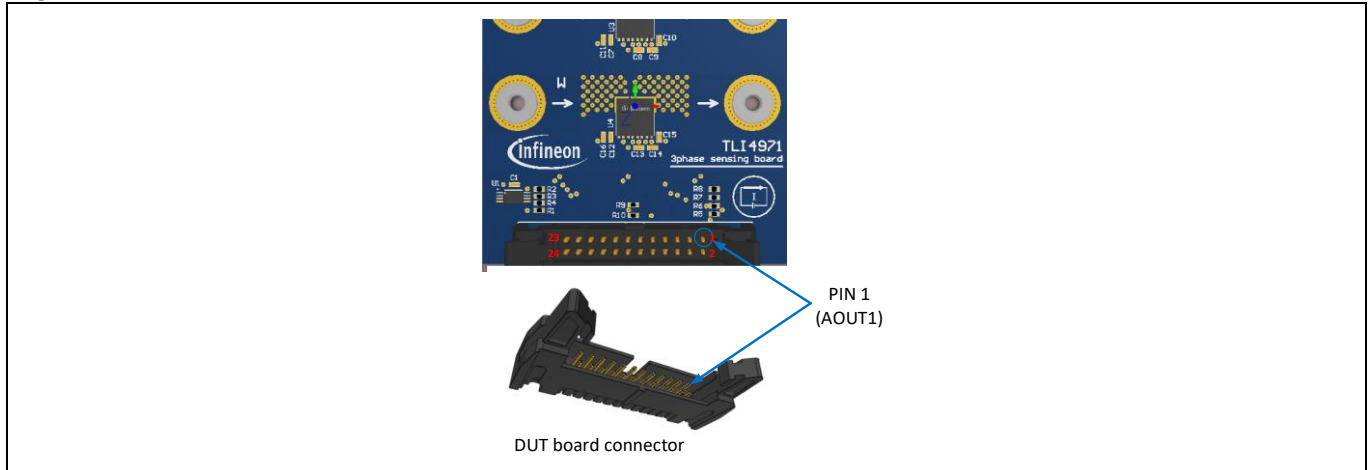

Figure 3 DUT board connector

Table 3 is describing the pin connector in detail.

Table 3 Measurement board Pin description

Pin Number	Symbol	Function
1	AOUT1	Analog output Voltage U-Phase
2	OCD_A1	Over Current Detection Channel 1, U-Phase (open drain)
3	VREF1	Analog voltage at reference output; U-Phase
4	OCD_B1	Over Current Detection Channel 2, U-Phase (open drain)
5	AOUT2	Analog output Voltage V-Phase
6	OCD_A2	Over Current Detection Channel 1, V-Phase (open drain)
7	VREF2	Analog voltage at reference output; V-Phase
8	OCD_B2	Over Current Detection Channel 2, V-Phase (open drain)
9	AOUT3	Analog output Voltage W-Phase
10	OCD_A3	Over Current Detection Channel 1, W-Phase (open drain)
11	VREF3	Analog voltage at reference output; W-Phase
12	OCD_B3	Over Current Detection Channel 2, W-Phase (open drain)
13	AOUT_comp1	Reserve, Additional ADC input on CUR SENSOR PROGRAMMER P14_7
14	VSNS	Sensor supply voltage
15	AOUT_comp2	Reserve, Additional ADC input on CUR SENSOR PROGRAMMER P14_9
16	V5	5V supply voltage
17	TRIG	External trigger input (connected to μ C XMC4700 P4_0 on the CUR SENSNOR PROGRAMMER board)
18	V_IO	For controller supply
19	SCL	Clock for PCB-EEPROM communication
20	GND	
21	SDA	Data link for PCB-EEPROM communication
22	GND	
23	-	
24	V33	3.3V supply

3 Thermal performance

3.1 Thermal evaluation

To evaluate the thermal behavior the reference board shown in Figure 4 is a possible approach.

This three phase board is also the suggested reference board by Infineon for high current and high voltage applications since the clearance and creepage constraints is met by the design.

The inner layer are only connected to the current rail in the area where the thermal vias are placed as shown in Figure 5.

This measurement has been repeated once with a Heat sink installed on the reference board as shown in Figure 7. One more measurement has been done by cooling the setup with the Heat sink with a fan.

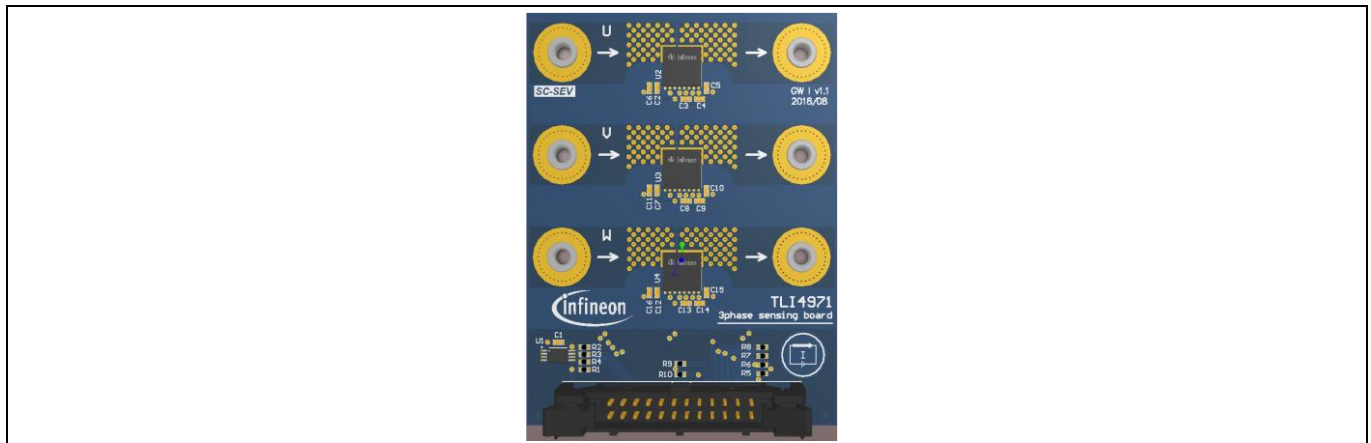

Figure 4 3-phase current sensor board with TLI4971 and programming/supply connector

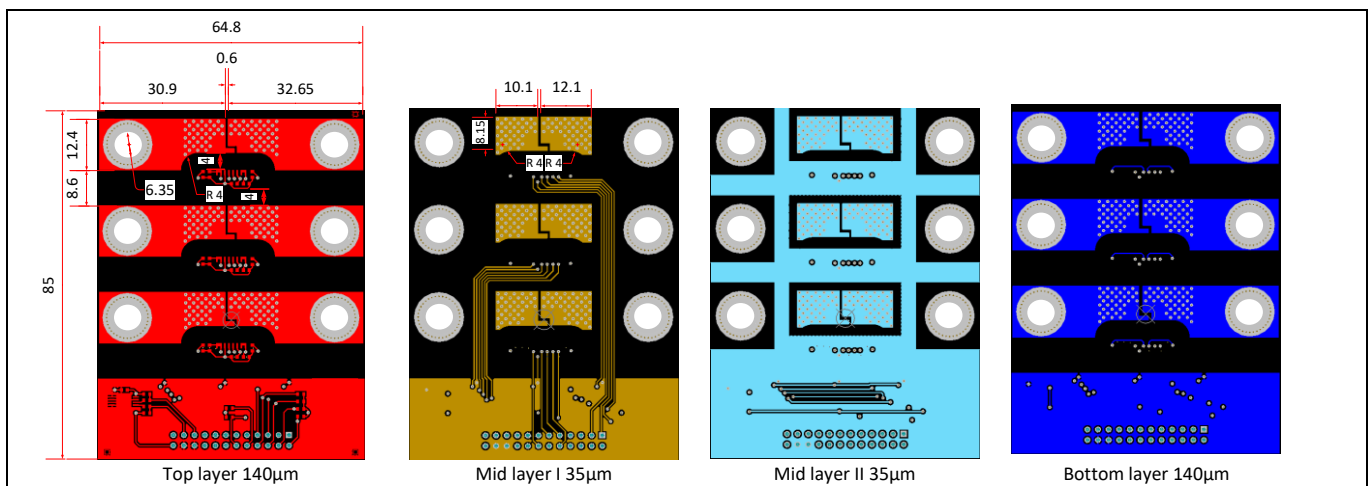

Figure 5 Board layout of 4-layer reference board (3-phase board)

Please contact your local Infineon sales office to order the sensor board or a programming board.

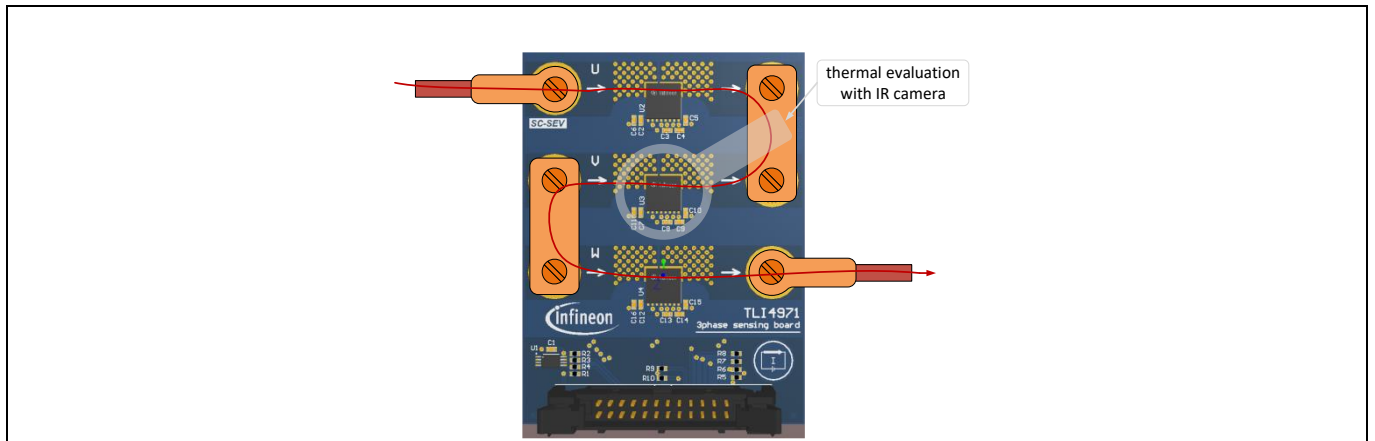

Figure 6 3-phase board setup for thermal evaluation; all sensors connected in series

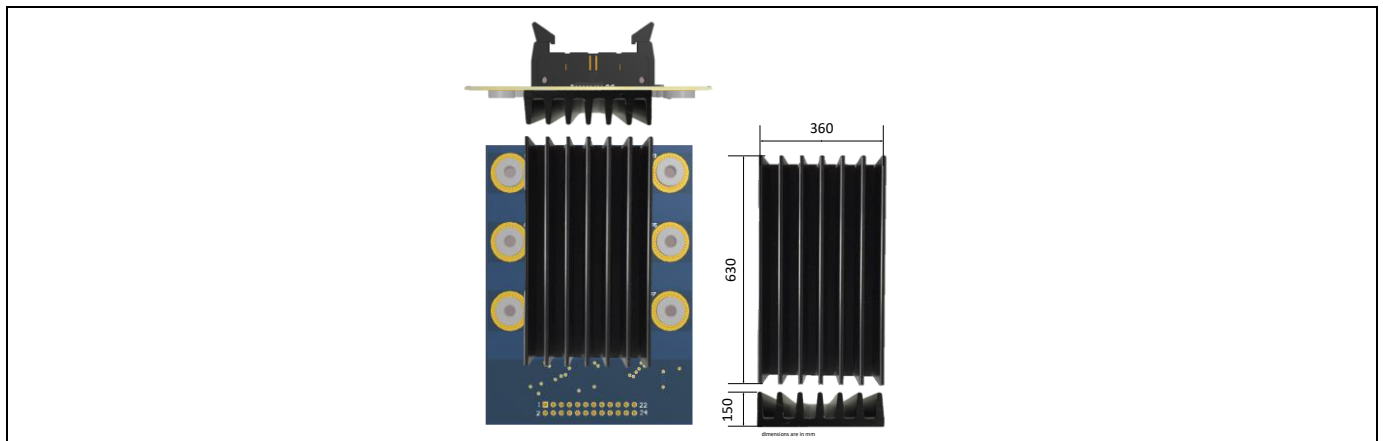

Figure 7 3-phase sensor board with temperature sink for thermal evaluation

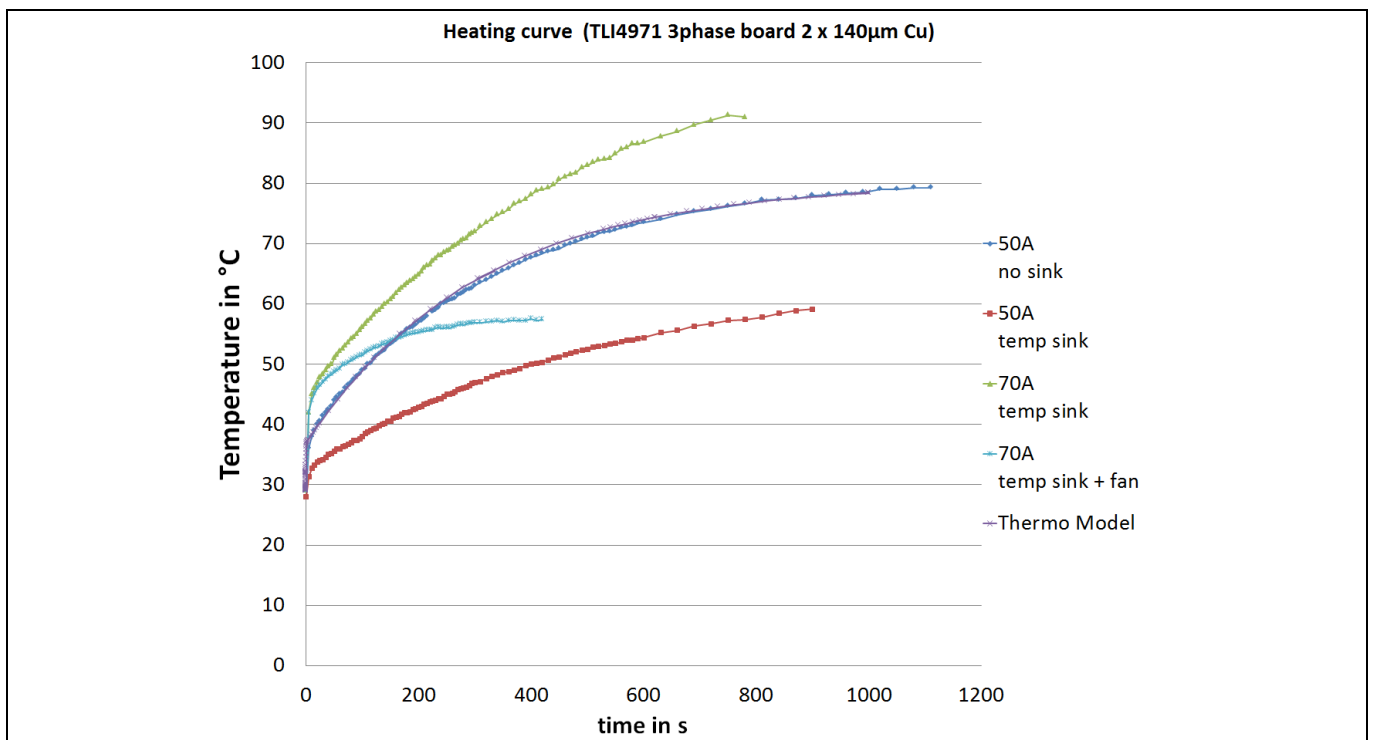

Figure 8 Thermal behavior over time dependent on applied current at the 3-phase reference board

- Derived from the board characterization an equivalent circuit diagram describing the thermal behavior of the sensor respectively the sensor soldered on the reference board is available.
- The circuit shown in Figure 9 is a simplify circuit to fit the thermal behavior of the reference board without any cooling. Therefore the circuit consists of two RC cascades.
- The values of the circuit are described in Table 4.

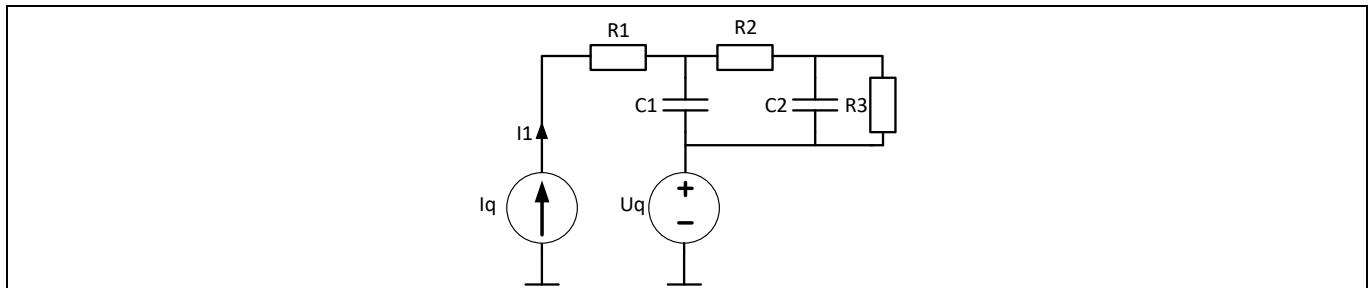

Figure 9 Equivalent circuit diagram to describe the thermal behavior of the 3-phase reference board

Table 4 Parameter values for equivalent circuit diagram (thermo-model)

Symbol	Value	description
Iq	10A	Current source 1A is equivalent to 1W
Uq	29V	Voltage Source 1V is equivalent to 1°C
I1		
R1	0.1Ω	
C1	0.6F	
R2	0.1 Ω	
C2		
R3	4.9 Ω	

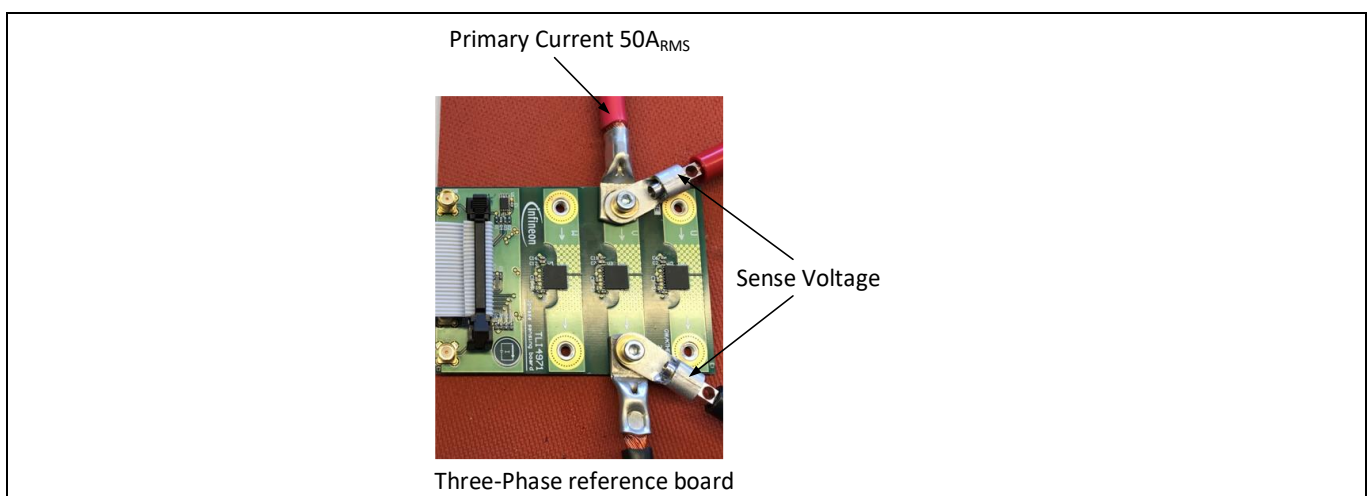

Figure 10 Measurement setup (heating curve with 50A load)

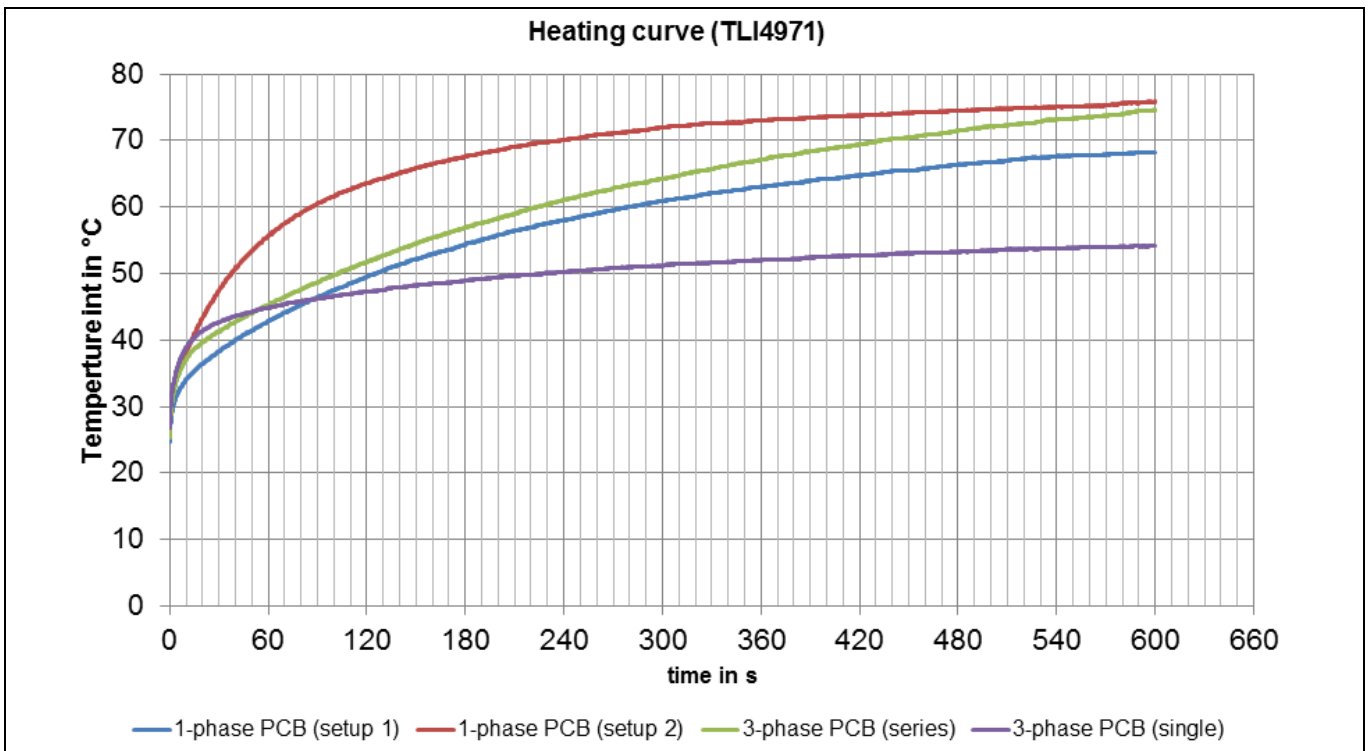

Figure 11 Heating curve (internal sensor temperature at 50A_RMS)

3.2 Thermal behavior comparison

The comparison shows the advantage of the Infineon leadless sensor package compared with leaded current sensor packages used by competitor.

Because of the high conductivity due to the Large exposed pads of the TLI4971 the temperature can be distributed to the PCB. Hence, leaded package like the tested SOIC-16 competitor package shows the disadvantage that the heat is poorly carried away from the package.

To compare the TLI4971 against SOIC-16 sensor the reference design for the Infineon current sensor has been adapted in order to fit to the competitor footprint respectively current rail design approach.

The layer stack are equal to the Infineon TLI4971 reference board. The size has been changed accordingly to the required clearance. Therefore, the distance between the neighbor phases has been changed slightly compared to the reference board.

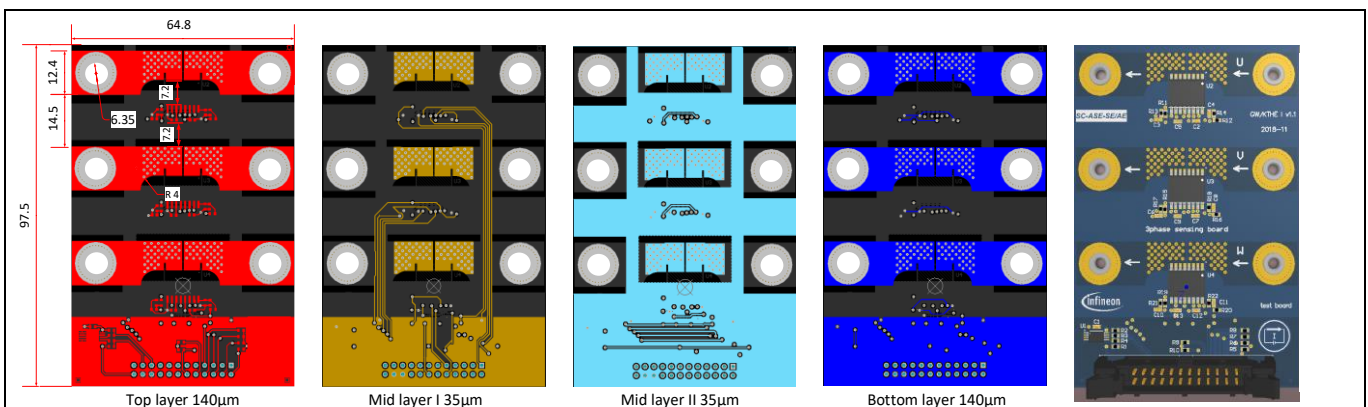

Figure 12 3-phase competitor board layout for thermal evaluation / comparison

In the competitor setup as well as in the Infineon setup the current has been given to the DUT on the middle phase as shown in Figure 13.

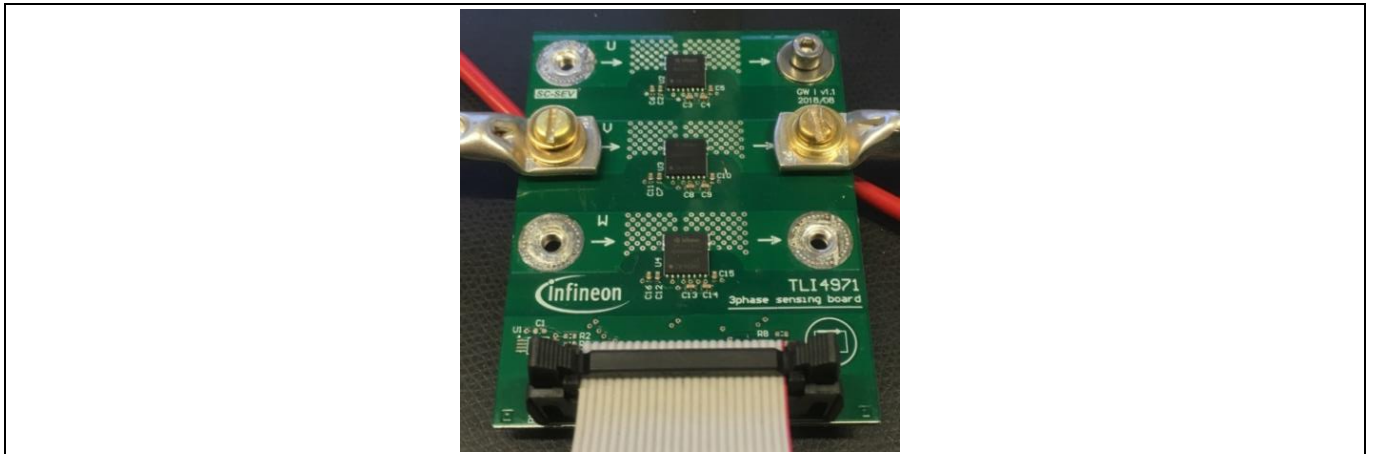

Figure 13 setup for thermal comparison measurement on the 3 phase sensor boards

- Figure 14 shows the infrared picture of the TLI4971 on the v-phase at the reference board. The good thermal conductivity between the sensor element and the PCB gives the advantage that the system can get cooled down by the periphery.
- Figure 15 shows that due to the leaded pins the thermal connectivity is less to get the heat into the PCB. Therefore the sensing element runs very hot.

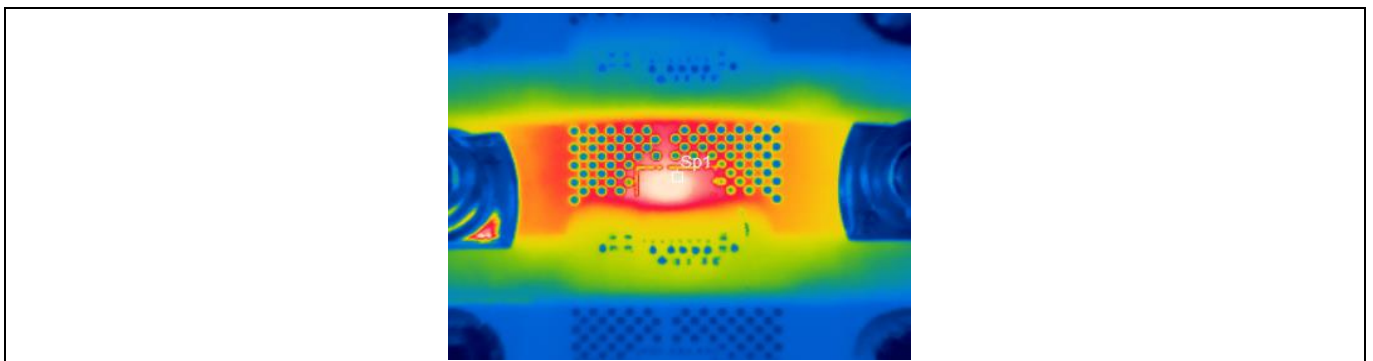

Figure 14 TLI4971 temperature distribution at 50A; (46.7°C package temperature)

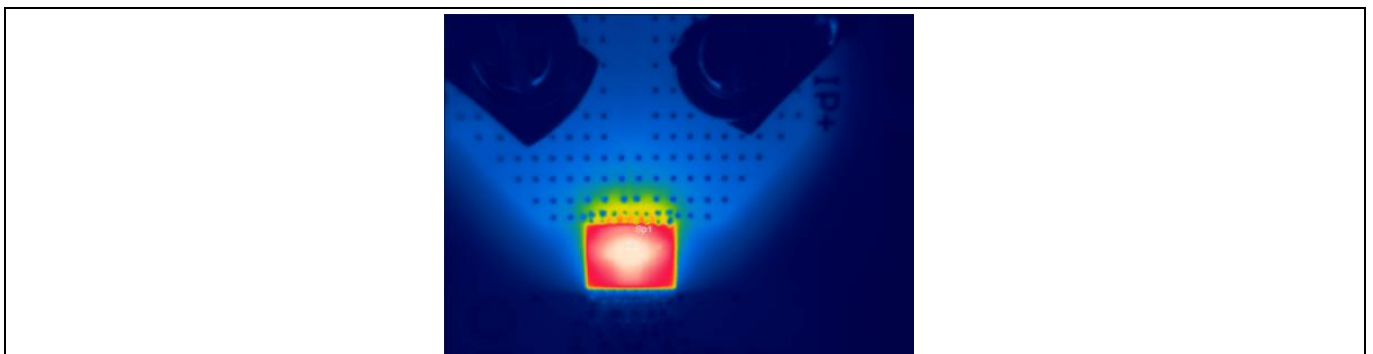

Figure 15 Leaded Competitor Sensor temperature distribution at 50A; (121°C package temperature)

4 Disclaimer

Please read & understand the following safety precautions

The 3-Phase Sensing Board is a sample to be used by the customer solely for the purpose of evaluation and testing. See Legal Disclaimer and Warnings for further restrictions on Infineon Technologies warranty and liability.

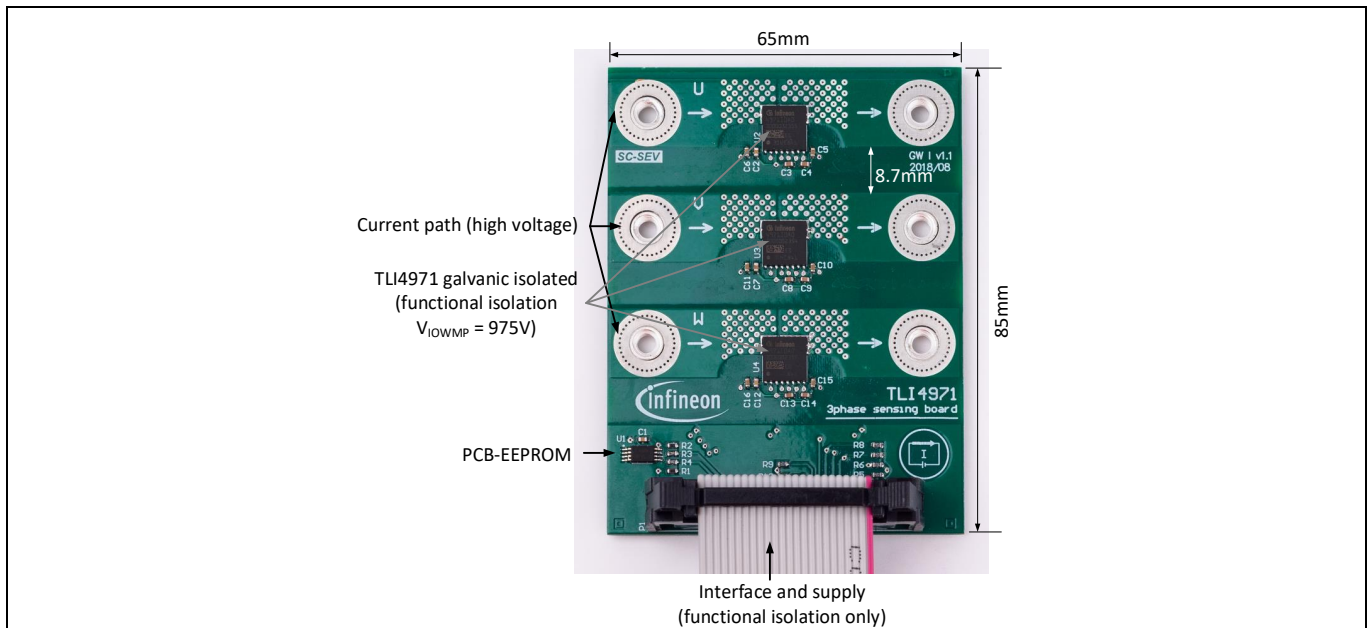







Figure 16 3-Phase Sensing Board

Safety precautions

	<p>Attention: The sensor device on the sensor board provides only functional isolation, the user has to take care for proper voltage isolation between high voltage and low voltage domain to be protected against injury or death. The customer assumes all responsibility and liability for its correct handling and/or use of the 3-Phase Sensor Board and undertakes to indemnify and hold Infineon Technologies harmless from any third party claim in connection with or arising out of the use and/or handling of the 3-Phase Sensor Board by the customer.</p>
	<p>Attention: It has to be considered that an additional isolation has to be added to the 3-Phase Sensor Board by the operator to protect the user against hazards caused by high voltage. Infineon do not provide any isolation to protect human live against high voltage on this sensor board. The responsibility is up to the user to install a proper isolation between the sensor board and the user interface. Failure to comply may result in personal injury or death.</p>
	<p>Attention: The design operates with unprotected high voltages. Therefore, only personnel familiar with power electronics high voltage applications and associated machinery should plan or implement the installation, start-up and subsequence maintenance of the sensor board in a high voltage environment. Failure to comply may result in personal injury and/or equipment damage.</p>
	<p>Attention: The sensor on the 3-Phase Sensor Board may become hot during sensing operation. The board is not designed to carry high current (maximum 20A_{DC} continuously) without additional cooling or temperature sinks. Hence, necessary precautions are required while handling the board, failure to comply may cause injury and / or equipment damage.</p>
	<p>Attention: A drive or load, incorrectly applied or installed, can result in component damage or reduction in production lifetime. Errors such as to high current or to high voltage or excessive ambient temperature may result in system malfunction.</p>
	<p>Attention: Sensing board using TLI4971 contains parts and assemblies sensitive to Electrostatic Discharge (ESD). Electrostatic control precautions are required when installing, testing, servicing or repairing this assembly. Component damage may result if ESD control procedures are not followed. If you are not familiar with electrostatic control procedures, refer to applicable ESD protection handbooks and guidelines.</p>

Revision history

Document version	Date of release	Description of changes
V1.2	2023-05-01	Adding TLE4971 to all relevant sections
V1.1	2022-06-01	Shortening some text-passages
V1.0	2021-04-08	Initial version

Trademarks

All referenced product or service names and trademarks are the property of their respective owners.

Edition 2023-05-01

Published by

Infineon Technologies AG

81726 Munich, Germany

© 2023 Infineon Technologies AG.

All Rights Reserved.

Do you have a question about this document?

Email: erratum@infineon.com

Document reference

AppNote TLI4971 / TLE4971 EVAL 120A

IMPORTANT NOTICE

The information contained in this application note is given as a hint for the implementation of the product only and shall in no event be regarded as a description or warranty of a certain functionality, condition or quality of the product. Before implementation of the product, the recipient of this application note must verify any function and other technical information given herein in the real application. Infineon Technologies hereby disclaims any and all warranties and liabilities of any kind (including without limitation warranties of non-infringement of intellectual property rights of any third party) with respect to any and all information given in this application note.

The data contained in this document is exclusively intended for technically trained staff. It is the responsibility of customer's technical departments to evaluate the suitability of the product for the intended application and the completeness of the product information given in this document with respect to such application.

For further information on the product, technology, delivery terms and conditions and prices please contact your nearest Infineon Technologies office (www.infineon.com).

WARNINGS

Due to technical requirements products may contain dangerous substances. For information on the types in question please contact your nearest Infineon Technologies office.

Except as otherwise explicitly approved by Infineon Technologies in a written document signed by authorized representatives of Infineon Technologies, Infineon Technologies' products may not be used in any applications where a failure of the product or any consequences of the use thereof can reasonably be expected to result in personal injury.