

ASMT-QWB2-Nxxxx

Super 0.5W White Power PLCC-4 Surface Mount LED Indicator



Data Sheet



Lead (Pb) Free
RoHS 6 fully
compliant



Description

The Super 0.5W White Power PLCC-4 SMT LED is first white mid-Power PLCC-4 SMT LEDs using InGaN chip technology. The package can be driven at high current due to its superior package design. The product is able to dissipate the heat more efficiently compared to the Power PLCC-4 SMT LEDs. These LEDs produce higher light output with better flux performance compared to the Power PLCC-4 SMT LED.

The Super 0.5W White Power PLCC-4 SMT LEDs are designed for higher reliability, better performance, and operate under a wide range of environmental conditions. The performance characteristics of these new mid-power LEDs make them uniquely suitable for use in harsh conditions such as in automotive applications, and in electronics signs and signals.

To facilitate easy pick and place assembly, the LEDs are packed in EIA-compliant tape and reel. Every reel is shipped in single intensity and color bin, to provide close uniformity. These LEDs are compatible with the IR solder reflow process.

Features

- Industry Standard PLCC 4 platform (3.2 x 2.8 x 1.9mm)
- High reliability LED package due to enhanced silicone resin material
- Mid-Power intensity brightness with optimum flux performance using InGaN chip technologies
- Available in Cool White
- High optical efficiency 30lm/W
- Available in 8mm carrier tape and 7 inch reel
- Low Thermal Resistance 60 °C/W
- Super wide viewing angle at 120°
- JEDEC MSL 2a

Applications

1. Interior automotive
 - a. Instrument panel backlighting
 - b. Central console backlighting
 - c. Navigation and audio system backlighting
 - d. Dome/Map lighting
 - e. Push button backlighting
 - f. Puddle lamp
 - g. Glove compartment illumination
2. Exterior automotive
 - a. Number plate illumination
 - b. Rear reverse lamp indicator
3. Electronic signs and signals
 - a. Decorative lighting
4. Office automation, home appliances, industrial equipment
 - a. Panel/button backlighting
 - b. Display backlighting

CAUTION: ASMT-QWB2-Nxxxx LEDs are Class 1C ESD sensitive. Please observe appropriate precautions during handling and processing. Refer to Avago Application Note AN-1142 for additional details.

Package Drawing

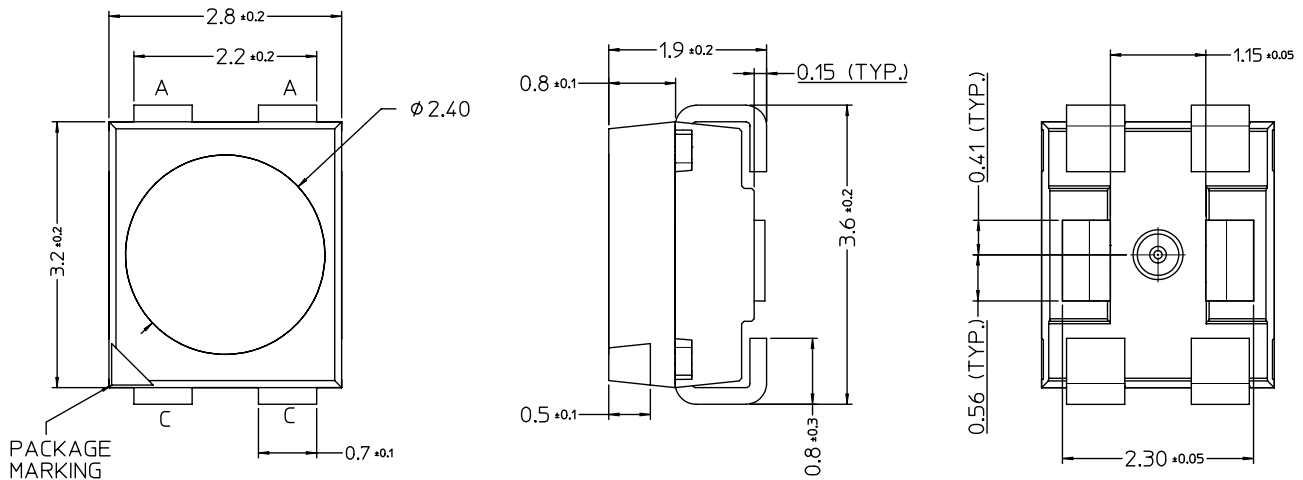

Note:

1. All Dimensions in millimeters.
2. Lead Polarity as shown in Figure 11.
3. Terminal Finish: Ag plating
4. Encapsulation material: Silicone resin

Figure 1. Package Drawing

Table 1. Device Selection Guide

Color	Part Number	Luminous Flux, Φ_V ^[1] (lm)			Test Current (mA)	Dice Technology
		Min. Flux (lm)	Typ. Flux (lm)	Max. Flux (lm)		
White	ASMT-QWB2-NEFOE	11.5	17.0	19.5	150	InGaN

Notes:

1. Φ_V is the total luminous flux output as measured with an integrating sphere at mono pulse conditions.
2. Tolerance = $\pm 12\%$

Part Numbering System

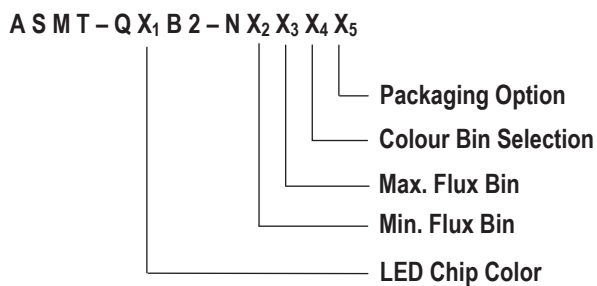

Table 2. Absolute Maximum Ratings (T_A = 25 °C)

Parameters	ASMT-QWB2-Nxxxx
DC Forward Current [1]	150 mA
Peak Forward Current [2]	300 mA
Power Dissipation	513 mW
Reverse Voltage	Not Recommended for Reverse Bias
Junction Temperature	125 °C
Operating Temperature	-40 °C to +110 °C
Storage Temperature	-40 °C to +110 °C

Notes:

1. Derate Linearly as shown in Figure 6.
2. Duty Factor = 10%, Frequency = 1kHz

Table 3. Optical Characteristics (T_A = 25 °C)

Color	Part Number	Dice Technology	Typical Chromaticity Coordinates ^[1]		Viewing Angle 2λ _{1/2} ^[2] (Degrees)	Luminous Efficacy η _V ^[3] (lm/W)	Luminous Efficiency η _e (lm/W)	Luminous Intensity / Total Flux I _V (cd) / φ _V (lm)
			x	y	Typ.	Typ.	Typ.	Typ.
White	ASMT-QWB2-Nxxxx	InGaN	0.31	0.31	120	289	30	0.35

Notes:

1. The dominant wavelength, λ_D, is derived from the CIE Chromaticity diagram and represents the color of the device.
2. θ_{1/2} is the off-axis angle where the luminous intensity is 1/2 the peak intensity.
3. Radiant intensity, I_e in watts / steradian, may be calculated from the equation I_e = I_V / η_V, where I_V is the luminous intensity in candelas and η_V is the luminous efficacy in lumens / watt.
4. φ_V is the total luminous flux output as measured with an integrating sphere at mono pulse conditions.

Table 4. Electrical Characteristics (T_A = 25 °C)

Part Number	Forward Voltage V _F (Volts) @ I _F = 150 mA		Thermal Resistance Rθ _{J-P} (°C/W)
	Typ.	Max.	
ASMT-QWB2-Nxxxx	3.6	4.1	60

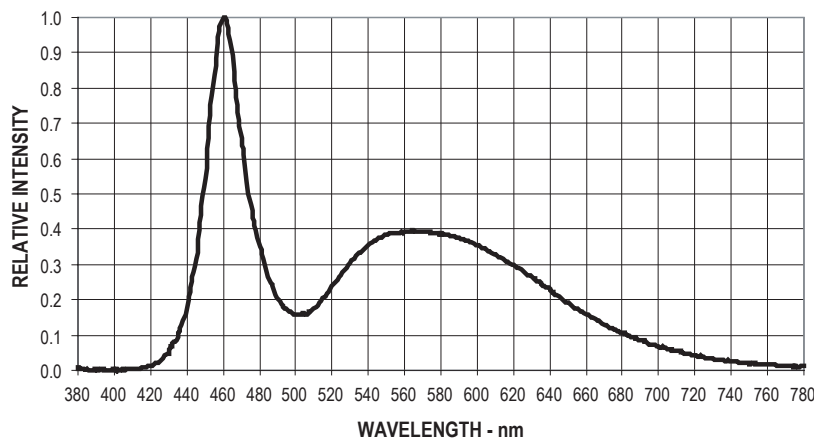

Figure 2. Relative Intensity Vs. Wavelength

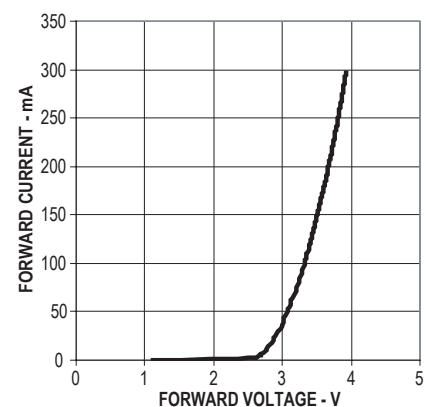

Figure 3. Forward Current Vs. Forward Voltage.

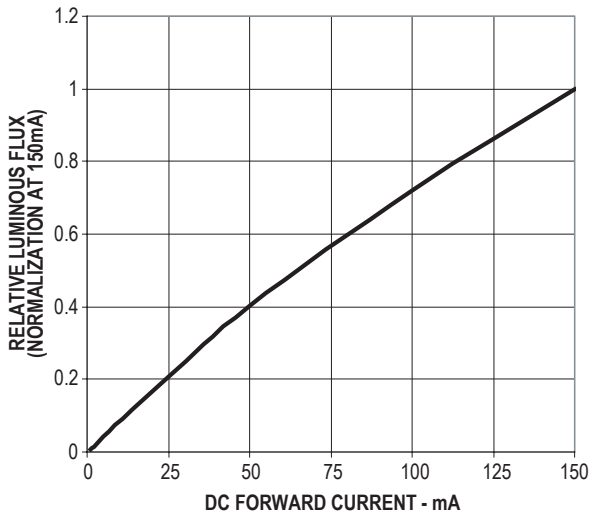

Figure 4. Relative Flux vs. Forward Current

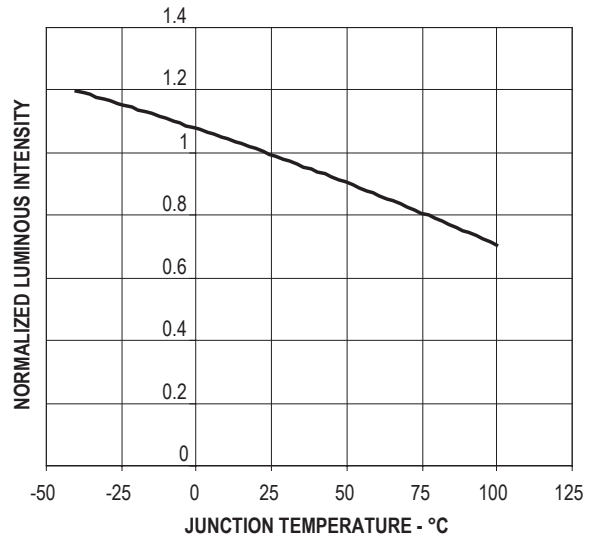

Figure 5. Relative Intensity vs. Temperature

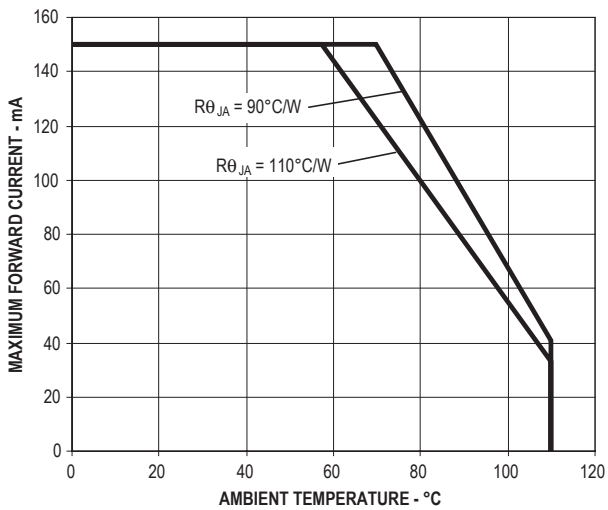

Figure 6a. Maximum Forward Current vs. Ambient Temperature. Derated Based on $T_{JMAX} = 125^{\circ}C$, $R_{\theta JA} = 90^{\circ}C/W$ and $110^{\circ}C/W$.

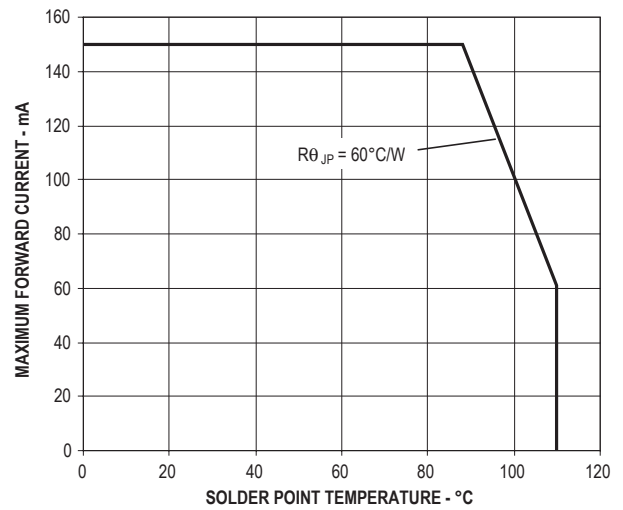

Figure 6b. Maximum forward current vs. solder point temperature. Derated Based on $T_{JMAX} = 125^{\circ}C$, $R_{\theta JP} = 60^{\circ}C/W$

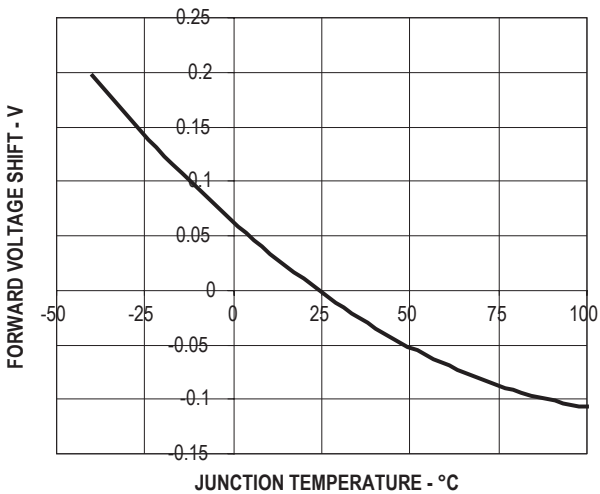

Figure 7. Forward Voltage Shift vs. Temperature.

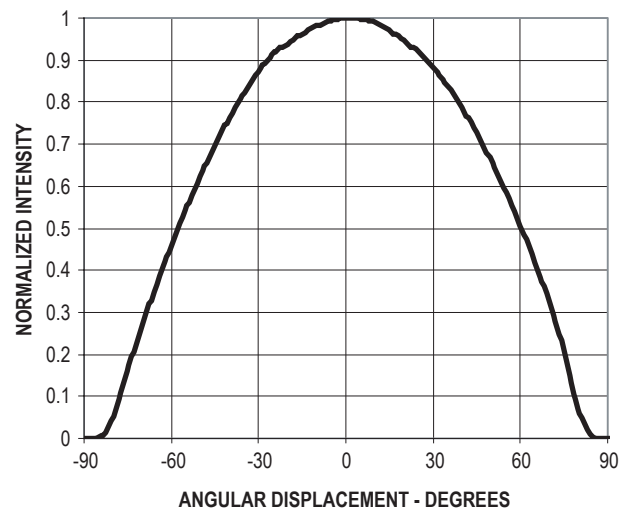

Figure 8. Radiation Pattern

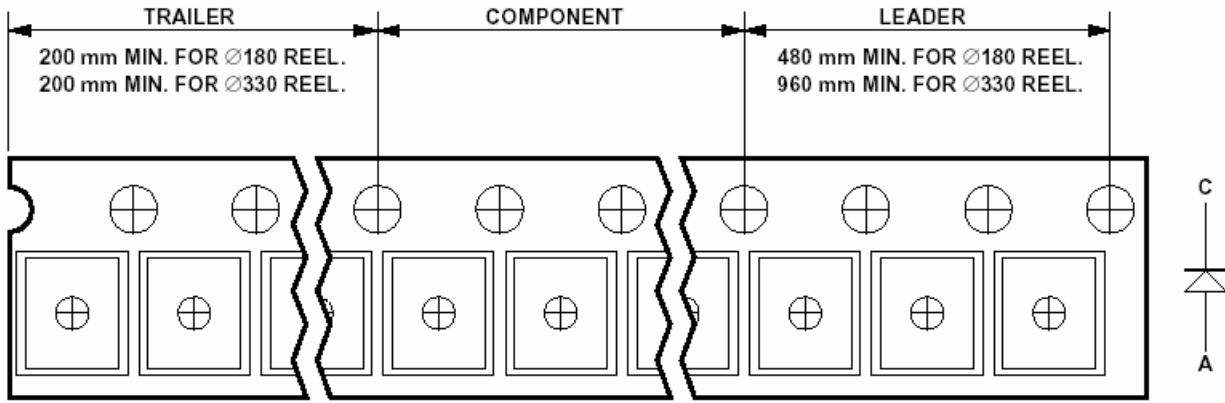

Figure 12. Tape Leader and Trailer Dimensions.

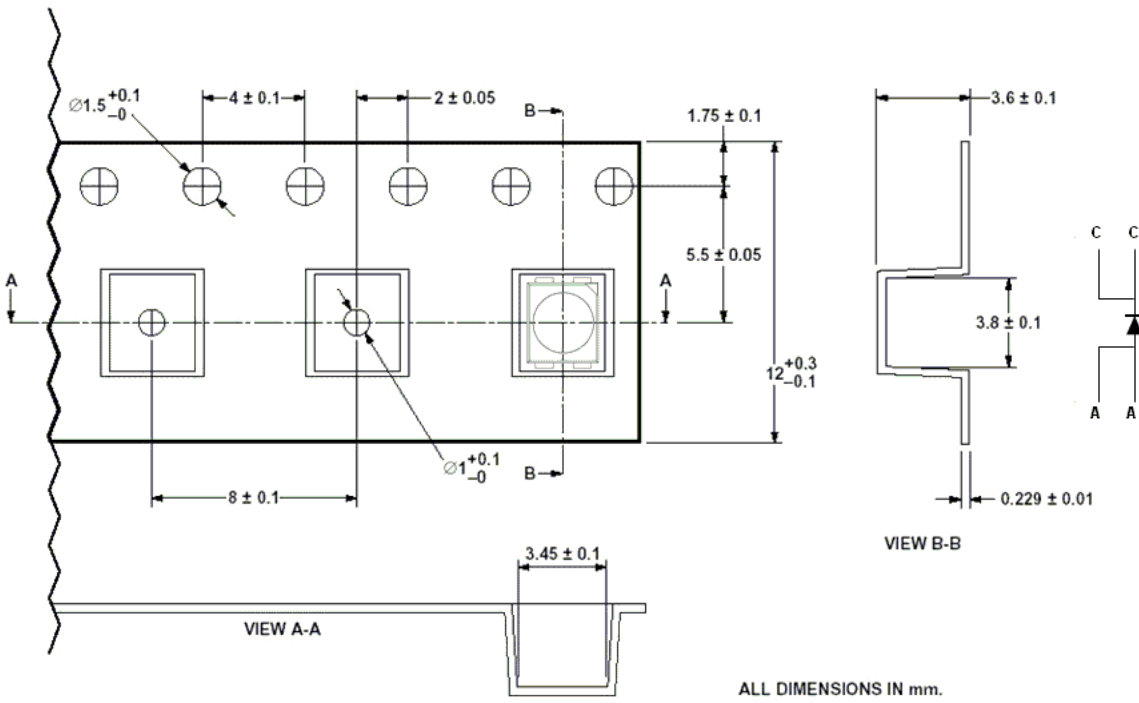

Figure 13. Tape Dimensions.

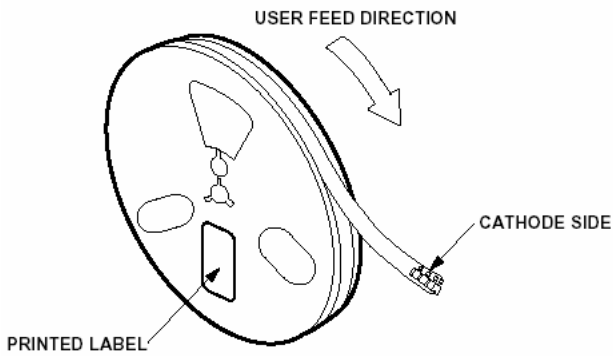

Figure 14. Reeling Orientation.

This product is qualified as Moisture Sensitive Level 2a per Jedec J-STD-020. Precautions when handling this moisture sensitive product is important to ensure the reliability of the product. Do refer to Avago Application Note AN5305 Handling of Moisture Sensitive Surface Mount Devices for details.

A. Storage before use

- Unopen moisture barrier bag (MBB) can be stored at <40°C/90%RH for 12 months. If the actual shelf life has exceeded 12 months and the HIC indicates that baking is not required, then it is safe to reflow the LEDs per the original MSL rating.
- It is not recommended to open the MBB prior to assembly (e.g. for IQC).

B. Control after opening the MBB

- The humidity indicator card (HIC) shall be read immediately upon opening of MBB.
- The LEDs must be kept at <30°C / 60%RH at all time and all high temperature related process including soldering, curing or rework need to be completed within 672 hours.

C. Control for unfinished reel

- For any unused LEDs, they need to be stored in sealed MBB with desiccant or desiccator at <5%RH.

D. Control of assembled boards

- If the PCB soldered with the LEDs is to be subjected to other high temperature processes, the PCB need to be stored in sealed MBB with desiccant or desiccator at <5%RH to ensure no LEDs have exceeded their floor life of 672 hours.

E. Baking is required if:

- "10%" is Not blue and "5%" HIC indicator turns pink.
- The LEDs are exposed to condition of >30°C / 60% RH at any time.
- The LEDs floor life exceeded 672 hours.

Recommended baking condition: 60±5°C for 20 hours.

Device Color (X₁)

W	White
---	-------

Flux Bin Select (X₂X₃)

Individual reel will contain parts from one bin only

X ₂	Min Flux Bin
X ₃	Max Flux Bin

Flux Bin Limits

Bin ID	Min. (lm)	Max. (lm)
A	4.30	5.50
B	5.50	7.00
C	7.00	9.00
D	9.00	11.50
E	11.50	15.00
F	15.00	19.50
G	19.50	25.50
H	25.50	33.00
J	33.00	43.00
K	43.00	56.00
L	56.00	73.00

Tolerance of each bin limit = ± 12%

Color Bin Select (X₄)

Individual reel will contain parts from one full bin only.

0	Full Distribution
A	1 and 2 only
B	2 and 3 only
C	3 and 4 only
D	4 and 5 only
E	5 and 6 only
G	1, 2 and 3 only
H	2, 3 and 4 only
J	3, 4 and 5 only
K	4, 5 and 6 only
M	1, 2, 3 and 4 only
N	2, 3, 4 and 5 only
P	3, 4, 5 and 6 only
R	1, 2, 3, 4 and 5 only
S	2, 3, 4, 5 and 6 only
Z	Special Color Bin

Color Bin Limits

Bin ID		Limits (Chromaticity Coordinates)			
1	x	0.296	0.291	0.310	0.313
	y	0.259	0.268	0.297	0.284
2	x	0.291	0.285	0.307	0.310
	y	0.268	0.279	0.312	0.297
3	x	0.313	0.310	0.330	0.330
	y	0.284	0.297	0.330	0.310
4	x	0.310	0.307	0.330	0.330
	y	0.297	0.312	0.347	0.330
5	x	0.330	0.330	0.338	0.352
	y	0.310	0.330	0.342	0.344
6	x	0.330	0.330	0.347	0.345
	y	0.330	0.347	0.371	0.352
7	x	0.352	0.338	0.364	0.360
	y	0.344	0.342	0.380	0.357
8	x	0.345	0.347	0.367	0.364
	y	0.352	0.371	0.401	0.380

Tolerance of each bin limit = ± 0.02

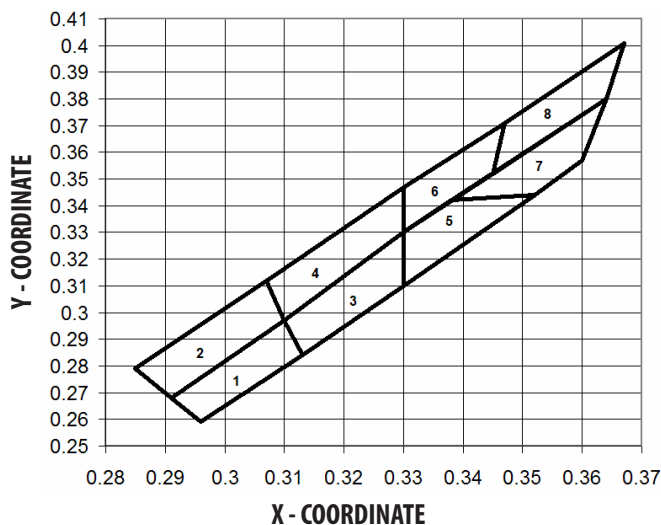

Handling Precaution

The encapsulation material of the product is made of silicone for better reliability of the product. As silicone is a soft material, please do not press on the silicone or poke a sharp object onto the silicone. These might damage the product and cause premature failure. During assembly or handling, the unit should be held on the body only. Please refer to Avago Application Note AN 5288 for detail information.

For product information and a complete list of distributors, please go to our web site: www.avagotech.com

Avago, Avago Technologies, and the A logo are trademarks of Avago Technologies Limited in the United States and other countries. Data subject to change. Copyright © 2005-2008 Avago Technologies Limited. All rights reserved. AV02-0209EN - May 23, 2008



VF Bin Limits

Bin ID	Min.	Max.
S5	3.20	3.50
S6	3.50	3.80
S7	3.80	4.10

Tolerance of each bin limit = $\pm 0.1V$

Packaging Option (X5)

Option	Test Current	Package Type	Reel Size
E	150mA	Top Mount	7 Inch