

AMMC-5040

20 – 45 GHz GaAs Amplifier

Data Sheet

Description

The AMMC-5040 is a high gain broadband amplifier designed for both military applications and commercial communication systems. This four-stage amplifier has input and output matching circuitry for use in 50 ohm environments. It is fabricated using PHEMT integrated circuit structures that provide exceptional broadband performance. The backside of this chip is both RF and DC ground. This simplifies the assembly process and reduces assembly related performance variations and costs. For improved reliability and moisture protection, the die is passivated at the active areas. This MMIC is a cost effective alternative to hybrid (discrete-FET) amplifiers that require complex tuning and assembly process.

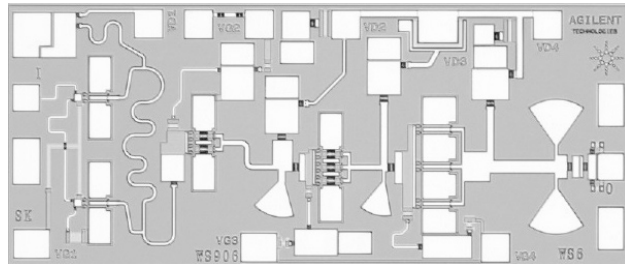

Chip Size: 1720 x 760 μm (67.7 x 29.9 mils)
 Chip Size Tolerance: $\pm 10 \mu\text{m}$ (± 0.4 mils)
 Chip Thickness: $100 \pm 10 \mu\text{m}$ (4 ± 0.4 mils)
 Pad Dimensions: $75 \times 75 \mu\text{m}$ (3 ± 0.4 mils)

Features

- Frequency range: 20 – 45 GHz
- High gain: 25 dB
- Gain flatness: ± 1.5 dB
- Return loss:
Input: 17 dB, Output: 11 dB
- Output power:
 $P_{-1\text{dB}} = 21$ dBm at 38 GHz
 $P_{-3\text{dB}} = 22.5$ dBm at 38 GHz

Applications

- Broadband gain block
- Broadband driver amplifier
- Point-to-point radio
- LMDS
- EW
- Instrumentation
- Frequency Multiplier (X2 and X3)

Absolute Maximum Ratings^[1]

Symbol	Parameters/Conditions	Units	Min.	Max.
$V_{D1,2-3-4}$	Drain Voltage	V		5
$V_{G1,2-3-4}$	Gate Voltage	V	-3.0	0.5
I_{DD}	Total Drain Current	mA		550
P_{in}	CW Input Power	dBm		21
T_{ch}	Operating Channel Temperature	$^{\circ}\text{C}$		+160
T_b	Operating Backside Temperature	$^{\circ}\text{C}$	-55	+75
T_{stg}	Storage Temperature	$^{\circ}\text{C}$	-65	+165
T_{max}	Max. Assembly Temp (60 sec max)	$^{\circ}\text{C}$		+300

Notes:

1. Operation in excess of any one of these conditions may result in permanent damage to this device.

AMMC-5040 DC Specifications/Physical Properties^[1]

Symbol	Parameters and Test Conditions	Units	Min.	Typ.	Max.
$V_{D1,2-3-4}$	Drain Supply Operating Voltage	V	2	4.5	5
I_{D1}	First Stage Drain Supply Current ($V_{DD} = 4.5\text{ V}$, $V_{G1} = -0.5\text{ V}$)	mA		50	
I_{D2-3-4}	Total Drain Supply Current for Stages 2, 3 and 4 ($V_{DD} = 4.5\text{ V}$, $V_{GG} = -0.5\text{ V}$)	mA		225	
$V_{G1,2-3-4}$	Gate Supply Operating Voltages ($I_{DD} = 300\text{ mA}$)	V		-0.45	
V_p	Pinch-off Voltage ($V_{DD} = 4.5\text{ V}$, $I_{DD} < 10\text{ mA}$)	V		-1.5	
θ_{ch-b}	Thermal Resistance ^[2] (Backside Temp. $T_b = 25^\circ\text{C}$)	$^\circ\text{C}/\text{W}$		49	

Notes:

1. Measured in wafer form with $T_{\text{chuck}} = 25^\circ\text{C}$ (except θ_{ch-b} .)
2. Channel-to-backside Thermal Resistance (θ_{ch-b}) = $58^\circ\text{C}/\text{W}$ at $T_{\text{channel}} (T_c) = 150^\circ\text{C}$ as measured using the liquid crystal method. Thermal Resistance at backside temperature (T_b) = 25°C calculated from measured data.

RF Specifications^[3,4] ($V_{DD} = 4.5\text{ V}$, $I_{DD} (Q) = 300\text{ mA}$, $Z_0 = 50\Omega$)

Symbol	Parameters and Test Conditions	Units	Broadband		Narrow Band Typical Performance			
			GHz	23–40	21–24	27–29	37–40	40–45
			Min.	Typ.	Typical			
$ S_{21} ^2$	Small-signal Gain	dB	20	25	25.5	25	22.4	21.3
$\Delta S_{21} ^2$	Small-signal Gain Flatness	dB		± 1.5	± 0.2	± 0.4	± 0.2	± 1.2
RL_{in}	Input Return Loss	dB	15	17	17	18	21	17
RL_{out}	Output Return Loss	dB	8	11	10	14	13	13
P_{-1dB}	Output Power @ 1 dB Gain Compression $f = 22\text{ GHz}$	dBm		19.5	20	22.5	21	20
P_{-3dB}	Output Power @ 3 dB Gain Compression, $f = 22\text{ GHz}$	dBm		21	21.6	23.5	22.5	21.5
OIP3	Output 3 rd Order Intercept Point, $\Delta f = 2\text{ MHz}$, $P_{in} = -8\text{ dBm}$, $f = 22\text{ GHz}$	dBm		30	29	29	31	27
$ S_{12} ^2$	Isolation	dB	40	55	55	55	55	55

Notes:

3. Data measured in wafer form, $T_{\text{chuck}} = 25^\circ\text{C}$.
4. 100% on-wafer RF test is done at frequency = 24, 27, 29, 37 and 40 GHz, except as noted.

AMMC-5040 Typical Performance ($T_{\text{chuck}} = 25^{\circ}\text{C}$)

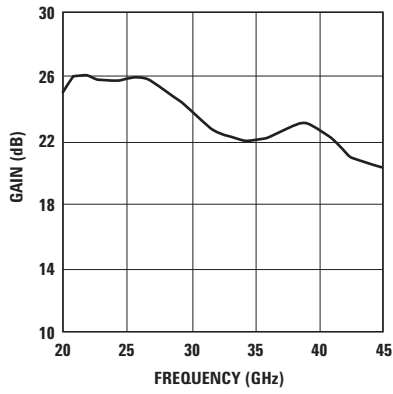

Figure 1. Gain, $V_{\text{DD}}=4.5\text{ V}$, $I_{\text{DD}}=300\text{ mA}$.

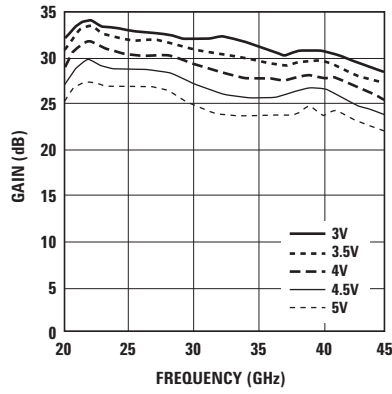

Figure 2. Gain and Drain Voltage, $I_{\text{DD}}=300\text{ mA}$.

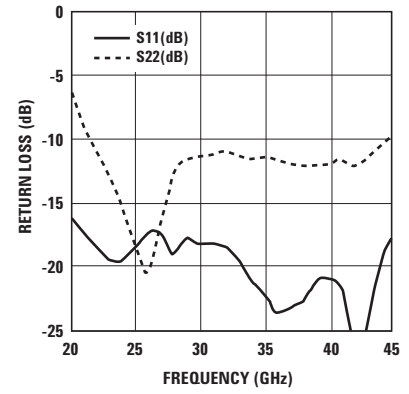

Figure 3. Input and Output Return Loss, $V_{\text{DD}}=4.5\text{ V}$, $I_{\text{DD}}=300\text{ mA}$.

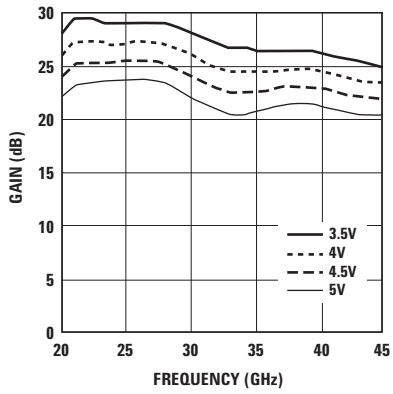

Figure 4. Gain and Drain Voltage, $I_{\text{DD}}=350\text{ mA}$.

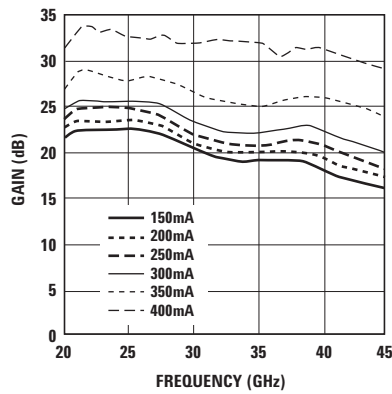

Figure 5. Gain and Drain Voltage, $I_{\text{DD}}=4.5\text{ V}$.

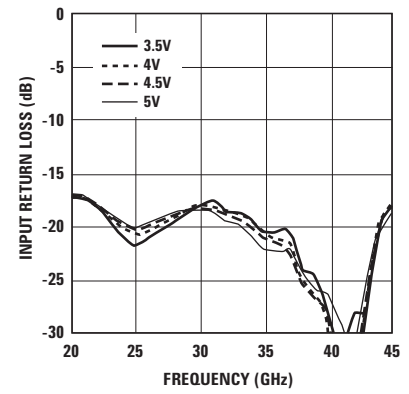

Figure 6. Input Return Loss and Drain Voltage, $I_{\text{DD}}=350\text{ mA}$.

AMMC-5040 Typical Performance ($T_{\text{chuck}} = 25^{\circ}\text{C}$)

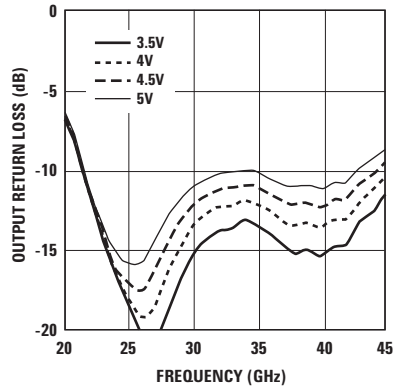

Figure 7. Output Return Loss and Drain Voltage, $I_{DD}=350$ mA.

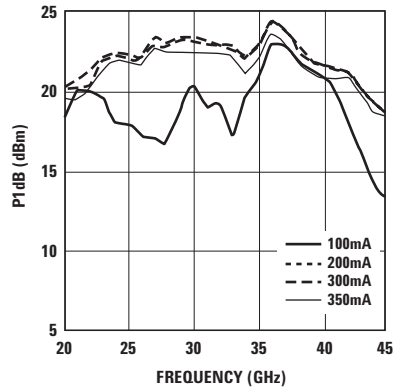

Figure 8. Output Power (P_{-1dB}) and Drain Current, $V_{DD}=4.5V$.

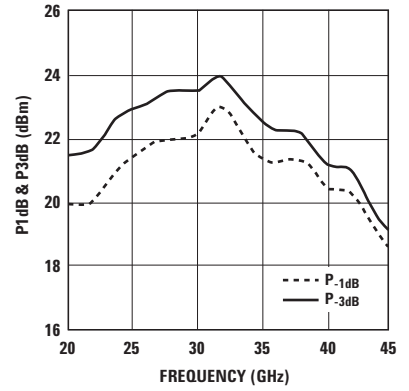

Figure 9. Output Power at P_{-1dB} and P_{-3dB} , $V_{DD}=4.5V$, $I_{DD}=300$ mA.

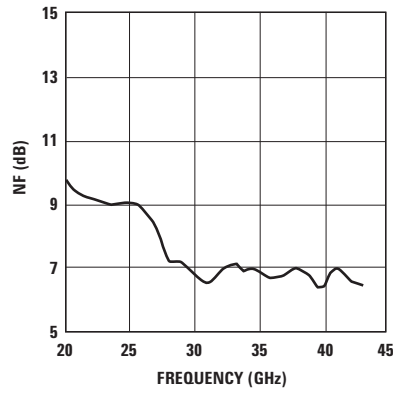

Figure 10. Noise Figure, $V_{DD}=4.5V$, $I_{DD}=300$ mA.

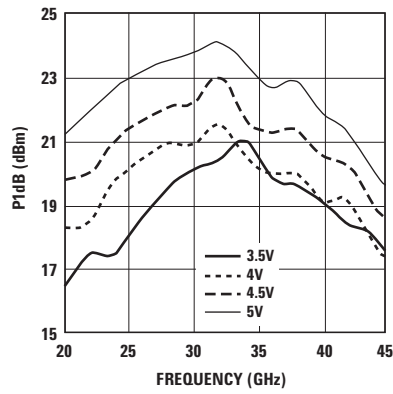

Figure 11. Output Power (P_{-1dB}) and Drain Voltage, $I_{DD}=300$ mA.

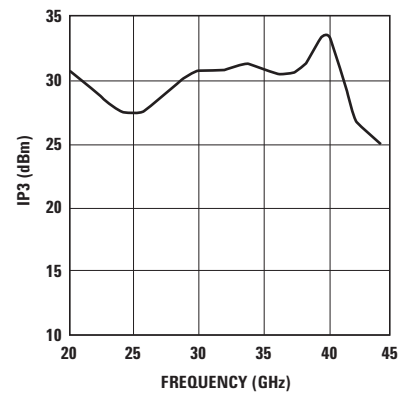

Figure 12. Output 3rd Order Intercept Point, $V_{DD}=4.5V$, $I_{DD}=300$ mA.

AMMC-5040 RF Performance for Frequency Multiplier Applications

Typical Performance as a X2 Frequency Multiplier, Input Power Optimized for Conversion Gain^[1]

Input Frequency (GHz)	Input Power (dBm)	Output Frequency (GHz)	Output Power (dBm)	Conversion Gain (dB)
10	6	20	18.2	12.2
11	6	22	18.9	12.9
12	6.5	24	20.5	14.0
13	6.5	26	20.8	14.3
14	7.5	28	20.0	12.4
15	7.5	30	19.6	12.1
16	7.5	32	18.0	10.5
17	7.5	34	16.0	8.5
18	7	36	11.7	4.7
19	7	38	7.1	0.1
20	3	40	7.0	4.0
21	5	42	10.7	5.7
22	5	44	11.3	6.3
23	5	46	11.7	6.7

Typical Performance as a X2 Frequency Multiplier, Input Power Optimized for Output Power^[1]

Input Frequency (GHz)	Input Power (dBm)	Output Frequency (GHz)	Output Power (dBm)	Conversion Gain (dB)
10	10	20	20.2	10.2
11	10	22	20.9	10.9
12	10	24	22.0	12.0
13	9.5	26	22.2	12.7
14	9.5	28	20.8	11.3
15	9.5	30	20.6	11.1
16	9.5	32	19.0	9.5

Typical Performance as a X3 Frequency Multiplier^[1]

Input Frequency (GHz)	Input Power (dBm)	Output Frequency (GHz)	Output Power (dBm)	Conversion Gain (dB)
7	14.3	21	19.6	5.3
8	14.2	24	20.6	6.4
9	15.1	27	20.0	4.9
10	15.9	30	18.6	2.6
11	15.8	33	16.0	0.2
12	15.8	36	14.7	-1.0
13	15.7	39	12.9	-2.7
14	15.6	42	10.0	-5.5

Note:

1. T = 25°C. Refer to "Multiplier Biasing and Operation" section for bias conditions for operation as a multiplier.

AMMC-5040 Typical Scattering Parameters⁽¹⁾ ($T_{\text{chuck}} = 25^{\circ}\text{C}$, $V_{\text{DD}} = 4.5\text{V}$, $I_{\text{DD}} = 300\text{mA}$, $Z_{\text{in}} = Z_{\text{out}} = 50\Omega$)

Freq. GHz	S_{11}			S_{21}			S_{12}			S_{22}		
	dB	Mag	Ang	dB	Mag	Ang	dB	Mag	Ang	dB	Mag	Ang
2.045	-15.17	0.174	-11	-24.59	0.059	130	0.00	0.000	-94	-0.77	0.915	-28
3.045	-15.12	0.175	-21	-12.70	0.232	5	-119.33	0.000	-1	-1.30	0.861	-40
4.045	-16.33	0.153	-23	-7.42	0.425	-146	-79.88	0.000	-156	-2.55	0.746	-51
5.045	-15.91	0.160	-23	-23.80	0.065	89	-79.88	0.000	0	-2.26	0.771	-54
6.045	-15.32	0.171	-28	-20.96	0.090	104	-80.00	0.000	-62	-2.66	0.736	-65
7.045	-15.04	0.177	-36	-22.62	0.074	23	-80.00	0.000	-75	-2.93	0.714	-72
8.045	-15.02	0.177	-44	-32.63	0.023	0	-80.00	0.000	-5	-2.91	0.715	-81
9.045	-15.06	0.177	-51	-37.54	0.013	19	-79.72	0.000	-73	-3.10	0.700	-92
10.045	-15.13	0.175	-57	-40.69	0.009	6	-70.46	0.000	-109	-3.31	0.683	-102
11.045	-15.19	0.174	-64	-34.93	0.018	-113	-70.46	0.000	-127	-3.56	0.664	-112
12.045	-15.24	0.173	-71	-21.52	0.084	-154	-68.05	0.000	-148	-3.79	0.647	-123
13.045	-15.31	0.172	-79	-12.30	0.243	176	-67.96	0.000	-139	-3.97	0.633	-135
14.045	-15.36	0.171	-86	-4.87	0.571	146	-63.04	0.001	-147	-4.27	0.612	-148
15.045	-15.47	0.168	-94	1.65	1.209	115	-60.92	0.001	178	-4.55	0.592	-162
16.045	-15.59	0.166	-103	7.60	2.399	82	-60.05	0.001	170	-4.80	0.575	-178
17.045	-15.74	0.163	-111	13.18	4.562	45	-60.80	0.001	168	-5.01	0.562	162
18.045	-15.93	0.160	-120	18.42	8.337	3	-59.94	0.001	148	-5.25	0.546	135
19.045	-16.31	0.153	-129	22.92	14.001	-46	-59.17	0.001	142	-5.87	0.509	98
20.045	-16.82	0.141	-138	25.67	19.201	-101	-58.42	0.001	142	-7.80	0.407	51
21.045	-17.28	0.137	-149	26.62	21.432	-153	-56.52	0.001	131	-10.92	0.284	4
22.045	-18.39	0.120	-156	26.58	21.318	163	-56.43	0.002	129	-13.81	0.204	-35
23.045	-19.92	0.101	-159	26.44	20.994	125	-54.46	0.002	110	-16.17	0.155	-63
24.045	-20.37	0.096	-160	26.48	21.078	90	-54.90	0.002	101	-18.24	0.122	-80
25.045	-20.61	0.093	-160	26.46	21.031	56	-54.81	0.002	93	-20.03	0.100	-81
26.045	-20.03	0.100	-160	26.43	20.964	22	-55.44	0.002	73	-20.25	0.097	-74
27.045	-18.87	0.114	-156	25.97	19.873	-11	-54.43	0.002	67	-17.79	0.129	-67
28.045	-17.38	0.135	-168	25.38	18.579	-43	-56.89	0.001	54	-15.30	0.172	-73
29.045	-17.55	0.133	174	24.53	16.837	-72	-59.51	0.001	27	-13.65	0.208	-84
30.045	-18.15	0.124	164	23.74	15.384	-99	-66.02	0.001	39	-12.32	0.242	-98
31.045	-18.91	0.113	155	23.17	14.407	-124	-63.24	0.001	85	-11.70	0.260	-113
32.045	-20.15	0.098	148	22.75	13.721	-148	-62.96	0.001	92	-11.40	0.269	-127
33.045	-21.06	0.088	140	22.45	13.260	-174	-58.42	0.001	91	-11.95	0.253	-144
34.045	-22.94	0.071	144	22.15	12.814	164	-62.23	0.001	120	-12.75	0.231	-155
35.045	-24.74	0.058	143	22.16	12.819	141	-56.92	0.001	109	-13.59	0.209	-163
36.045	-27.27	0.043	160	22.51	13.343	117	-54.15	0.002	85	-13.86	0.203	-170
37.045	-24.62	0.059	176	22.99	14.110	90	-56.75	0.001	78	-13.87	0.203	177
38.045	-22.97	0.071	178	23.23	14.505	61	-54.49	0.002	73	-14.15	0.196	162
39.045	-22.55	0.075	168	22.94	14.022	31	-53.44	0.002	86	-15.02	0.177	146
40.045	-22.63	0.074	167	22.33	13.075	3	-51.15	0.003	68	-15.50	0.168	131
41.045	-24.00	0.063	164	21.78	12.275	-23	-52.29	0.002	63	-15.82	0.162	117
42.045	-25.45	0.053	168	21.48	11.861	-50	-51.10	0.003	54	-14.49	0.189	104
43.045	-27.06	0.044	-171	21.17	11.442	-78	-51.37	0.003	45	-12.76	0.230	84
44.045	-25.94	0.050	-139	20.75	10.907	-107	-51.37	0.003	43	-11.21	0.275	63
45.045	-22.48	0.075	-123	20.32	10.371	-136	-51.99	0.003	41	-9.70	0.327	44
46.045	-20.26	0.097	-112	19.51	9.453	-166	-49.59	0.003	22	-8.14	0.392	24
47.045	-15.70	0.164	-103	19.00	8.917	165	-50.75	0.003	18	-7.25	0.434	7
48.045	-11.42	0.269	-106	18.44	8.355	134	-53.08	0.002	17	-6.43	0.477	-8
49.045	-7.83	0.406	-113	17.70	7.677	101	-54.51	0.002	6	-5.73	0.517	-22
50.000	-4.72	0.581	-124	16.85	6.955	69	-54.43	0.002	13	-5.20	0.550	-34

Note:

1. Data obtained from on-wafer measurements.

AMMC-5040 Typical Scattering Parameters⁽¹⁾ ($T_{\text{chuck}} = 25^{\circ}\text{C}$, $V_{\text{DD}} = 4.5\text{V}$, $I_{\text{DD}} = 350\text{mA}$, $Z_{\text{in}} = Z_{\text{out}} = 50\Omega$)

Freq. GHz	S_{11}			S_{21}			S_{12}			S_{22}		
	dB	Mag	Ang	dB	Mag	Ang	dB	Mag	Ang	dB	Mag	Ang
17.045	-15.90	0.160	-111	13.73	4.857	45	-61.03	0.001	168	-4.89	0.569	162
18.045	-16.10	0.157	-120	19.07	8.981	3	-59.90	0.001	148	-4.99	0.565	135
19.045	-16.50	0.150	-129	23.92	15.696	-46	-59.17	0.001	142	-5.06	0.558	98
20.045	-17.08	0.140	-138	27.37	23.362	-101	-59.17	0.001	142	-6.08	0.496	51
21.045	-17.41	0.135	-149	28.96	28.054	-153	-57.08	0.001	131	-8.51	0.375	4
22.045	-18.78	0.115	-156	29.01	28.221	163	-56.48	0.002	129	-11.29	0.273	-35
23.045	-20.82	0.091	-159	28.73	27.316	125	-54.47	0.002	110	-13.84	0.203	-63
24.045	-21.45	0.085	-160	28.65	27.069	90	-54.94	0.002	101	-16.02	0.158	-80
25.045	-21.92	0.080	-160	28.56	26.789	56	-54.94	0.002	93	-18.15	0.124	-81
26.045	-21.45	0.085	-160	28.55	26.759	22	-55.35	0.002	73	-19.22	0.109	-74
27.045	-20.21	0.098	-156	28.13	25.497	-11	-54.46	0.002	67	-17.68	0.131	-67
28.045	-18.06	0.125	-168	27.69	24.224	-43	-57.03	0.001	54	-15.15	0.175	-73
29.045	-17.86	0.128	174	26.95	22.266	-72	-58.31	0.001	27	-13.32	0.216	-84
30.045	-18.39	0.120	164	26.21	20.450	-99	-67.65	0.000	39	-11.78	0.258	-98
31.045	-19.04	0.112	155	25.65	19.164	-124	-63.27	0.001	85	-11.03	0.281	-113
32.045	-20.32	0.096	148	25.17	18.142	-148	-63.18	0.001	92	-10.68	0.293	-127
33.045	-21.10	0.088	140	24.88	17.541	-174	-59.22	0.001	91	-11.06	0.280	-144
34.045	-23.60	0.066	144	24.53	16.846	164	-62.19	0.001	120	-11.85	0.256	-155
35.045	-25.31	0.054	143	24.49	16.767	141	-57.76	0.001	109	-12.74	0.231	-163
36.045	-30.41	0.030	160	24.81	17.394	117	-54.43	0.002	85	-13.14	0.220	-170
37.045	-27.92	0.040	176	25.38	18.567	90	-57.60	0.001	78	-13.17	0.220	177
38.045	-25.80	0.051	178	25.75	19.376	61	-55.00	0.002	73	-13.64	0.208	162
39.045	-24.94	0.057	168	25.56	18.956	31	-54.00	0.002	86	-14.93	0.179	146
40.045	-25.03	0.056	167	25.03	17.850	3	-51.42	0.003	68	-15.86	0.161	131
41.045	-26.05	0.050	164	24.59	16.970	-23	-52.75	0.002	63	-16.32	0.153	117
42.045	-27.13	0.044	168	24.45	16.696	-50	-51.37	0.003	54	-14.81	0.182	104
43.045	-29.59	0.033	-171	24.29	16.386	-78	-51.37	0.003	45	-13.01	0.224	84
44.045	-29.99	0.032	-139	24.07	15.984	-107	-51.39	0.003	43	-11.47	0.267	63
45.045	-26.40	0.048	-123	23.89	15.652	-136	-52.38	0.002	41	-9.86	0.322	44
46.045	-24.89	0.057	-112	23.32	14.648	-166	-49.39	0.003	22	-7.99	0.398	24
47.045	-18.50	0.119	-103	23.14	14.361	165	-50.47	0.003	18	-7.07	0.443	7
48.045	-13.21	0.219	-106	22.81	13.814	134	-52.77	0.002	17	-6.17	0.492	-8
49.045	-9.10	0.351	-113	22.15	12.804	101	-53.15	0.002	6	-5.41	0.537	-22
50.000	-5.48	0.532	-124	21.30	11.608	69	-55.92	0.002	13	-4.88	0.570	-34

Note:

1. Data obtained from on-wafer measurements.

Biasing and Operation

The recommended DC bias condition for the AMMC-5040 is with all four drains connected to a single 4.5V supply and all four gates connected to an adjustable negative voltage supply as shown in Figure 15. The gate voltage is adjusted for a total drain supply current of typically 300 mA. Figures 1–12 can be used to help estimate the minimum drain voltage and current necessary for a given RF gain and output power.

As shown in Figure 13, the second, third, and fourth stage DC drain bias lines are connected internally and therefore require only a single bond wire. An additional bond wire is needed for the first stage DC drain bias, Vd1.

Only the third and fourth stage DC gate bias lines are connected internally. A total of three DC gate bond wires are required: one for Vg1, one for Vg2, and one for the Vg3/Vg4 connection. The internal matching circuitry at the RF input creates a 50-ohm DC and RF path to ground. A blocking capacitor should be used at the RF input. Any DC voltage applied to the RF input must be maintained below 1V. The RF output is AC coupled. No ground bond wires are needed since the ground connection is made by means of plated through via holes to the backside of the chip.

Frequency Multiplier Biasing and Operation

The AMMC-5040 can also be used as a frequency doubler, tripler or quadrupler.

As a frequency doubler, the AMMC-5040 provides conversion gain for input signals in the 10–23 GHz frequency range for output frequencies of 20–46 GHz. Similarly, 5–10 GHz signals can be quadrupled up to 20–40 GHz with some conversion loss.

Optimum conversion efficiency as a doubler is obtained with an input power level of 3–8 dBm. For use as a frequency tripler, an input power level of 14–16 dBm is recommended.

Frequency multiplication is achieved by reducing the bias on the first stage FET to efficiently generate harmonics. The remaining three stages are then used to provide amplification.

While many bias schemes may be used to generate and amplify the desired harmonics within the AMMC-5040, the following information is suggested as a starting point for multiplier applications.

Frequency doubling or quadrupling (generation of even harmonics) is accomplished by biasing the first stage FET at pinch-off by setting $V_{g1} = V_p \approx -1.1$ volts. The remaining three stages are biased for normal amplification, e.g., Vgg is adjusted such that $I_{d2} + I_{d3}$

+ $I_{d4} \approx 250$ mA. The drain voltage, Vdd, for all four stages should be 3.5–4.5 volts. The assembly diagram shown in Figure 16 can be used as a guideline.

To operate the AMMC-5040 as a frequency tripler (odd harmonic), the device is biased as shown in Figure 17. The drain voltage for the first stage FET is biased separately with Vd1 reduced to 1.1 - 1.2 volts. The drain voltage for the remaining three stages, Vd2, Vd3, and Vd4, should be 3.5 - 4.5 volts. All four gate voltages, Vgg, are set to approximately –0.6 volts. If desired, Vgg can be adjusted to minimize second harmonics. Improved multiplier performance can be obtained by biasing both the gate and drain voltages for the first stage separately from stages 2–4.

In all cases, $C_b > 100$ nF to assure stability.

Assembly Techniques

The chip should be attached directly to the ground plane using either a fluxless AuSn solder preform or electrically conductive epoxy^[1]. For conductive epoxy, the amount should be just enough to provide a thin fillet around the bottom perimeter of the die. The ground plane should be free of any residue that may jeopardize electrical or mechanical attachment. Caution should be taken to not exceed the Absolute Maximum Rating for assembly temperature and time.

Thermosonic wedge bonding is the preferred method for wire attachment to the bond pads. The RF connections should be kept as short as possible to minimize inductance. Gold mesh^[2] or double-bonding with 0.7 mil gold wire is recommended.

Mesh can be attached using a 2 mil round tracking tool and a tool force of approximately 22 grams with an ultrasonic power of roughly 55 dB for a duration of 76 ± 8 mS. A guided wedge at an ultrasonic power level of 64 dB can be used for the 0.7 mil wire. The recommended wire bond stage temperature is $150 \pm 2^\circ\text{C}$.

The chip is 100 mm thick and should be handled with care.

This MMIC has exposed air bridges on the top surface. Handle at edges or with a custom collet (do not pick up die with vacuum on die center.)

This MMIC is also static sensitive and ESD handling precautions should be taken.

For more information, see Avago Application Note 54 "GaAs MMIC ESD, Die Attach and Bonding Guidelines."

Notes:

1. Ablebond 84-1 LM1 silver epoxy is recommended.
2. Buckbee-Mears Corporation, St. Paul, MN, 800-262-3824

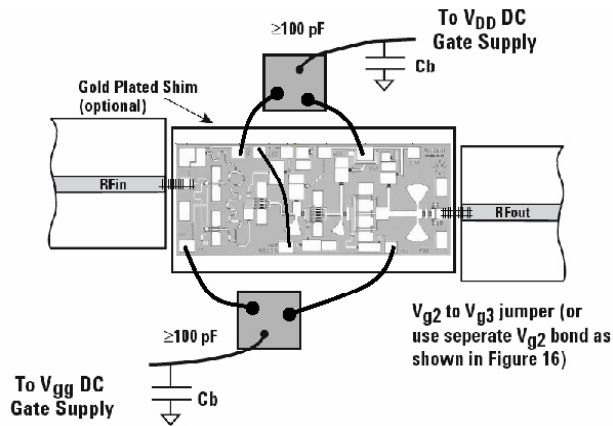

Figure 15. AMMC-5040 assembly for normal amplifier applications with single drain and single gate supply connections.

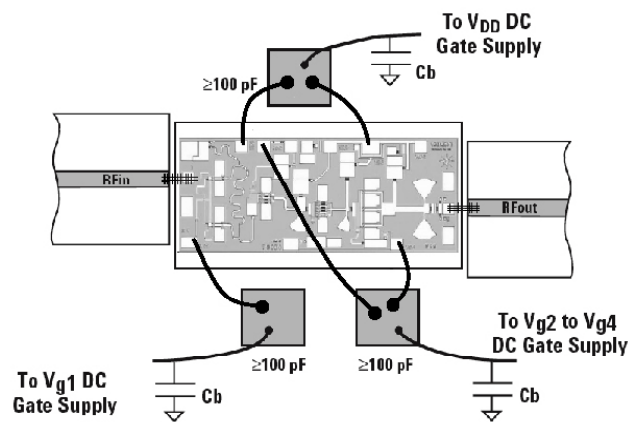

Figure 16. Separate first-stage gate bias for using the AMMC-5040 as a frequency doubler or quadrupler. This diagram also shows an option to the V_{g2} jumper bonding scheme used in Figure 15.

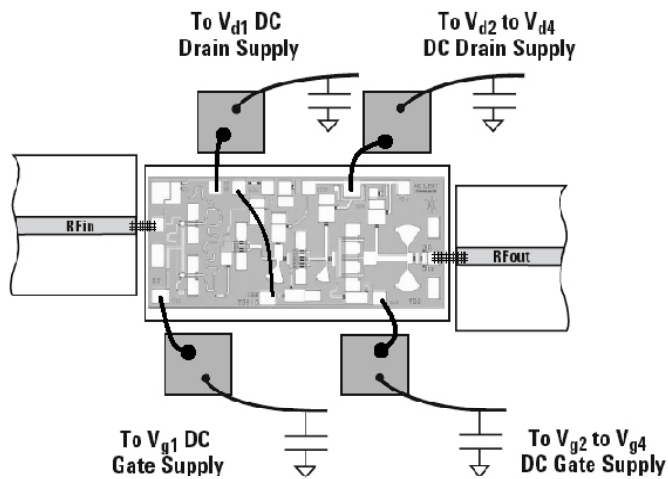

Figure 17. Separate first-stage gate and drain bias for using the AMMC-5040 as a frequency tripler.

Ordering Information

AMMC-5040-W10 = 10 devices per tray

AMMC-5040-W50 = 50 devices per tray

For product information and a complete list of distributors, please go to our web site: www.avagotech.com

Avago, Avago Technologies, and the A logo are trademarks of Avago Technologies, Limited in the United States and other countries. Data subject to change. Copyright © 2006 Avago Technologies, Limited. All rights reserved. Obsoletes 5989-4041EN AV01-0605EN - October 26, 2006

Avago
TECHNOLOGIES