

LV885XXJA-GEVB

Evaluation Board for Motor Driver, Single-phase, PWM, Full-wave, BLDC Motor



ON Semiconductor®

www.onsemi.com

USER GUIDE

Overview

This evaluation board is designed to provide an easy and quick development platform for single-phase BLDC motor control applications, using the following devices.

- LV88551, LV88552, LV88553, LV88554
- LV88561, LV88562, LV88563, LV88564

These devices have the closed loop controller for motor rotation speed. And, potentiometers are provided on this board to configure the minimum/maximum target speed, the speed curve against the input PWM duty cycle, and some other parameters/options. The potentiometers might be useful for tuning these parameters and options, otherwise fixed resistors must be removed and re-soldered.

Setting with fixed resistors is also applicable by disconnecting the potentiometers.

Quick start

The evaluation board is programmed to work standalone without PC. The following operation allows the operation of most motors with the default parameters that are preloaded into the device.

- Step 1. Connect a motor to J3
- Step 2. Connect PWM signal to the pin labeled 'PWM'
- Step 3. Connect a power supply to J4 (J5 is provided optionally for low power application less than 4A).
- Step 4. Turn on power supply

Features

- LV88551JAGEVB LV88551RGEVB
- LV88552JAGEVB LV88552RGEVB
- LV88553JAGEVB LV88553RGEVB
- LV88554JAGEVB LV88554RGEVB
- LV88561JAGEVB LV88561RGEVB
- LV88562JAGEVB LV88562RGEVB
- LV88563JAGEVB LV88563RGEVB
- LV88564JAGEVB LV88564RGEVB

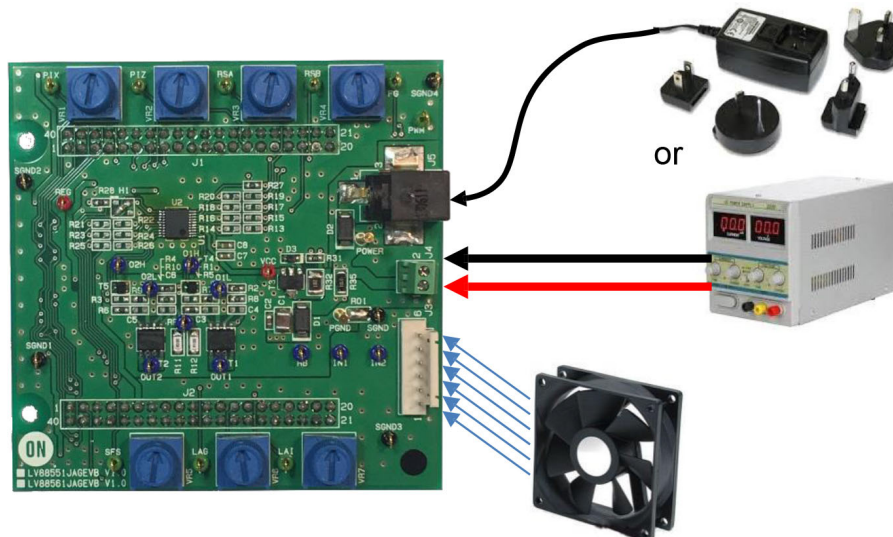

LV885XXJA-GEVB

HARDWARE DESCRIPTION

Table 1. NAME AND FUNCTION

1.	Evaluation board	The main board
2.	Connector J4	Main power connector
3.	Connector J5	Optional power jack
4.	Connector J3	Motor windings and signals related Hall
5.	Pin PWM	PWM input
6.	Pin FG	FG output
7.	IC U1 (or U2)	A dial to tweak the command PWM duty cycle for speed control
8.	FETs T1 and T2	Output power FET arrays

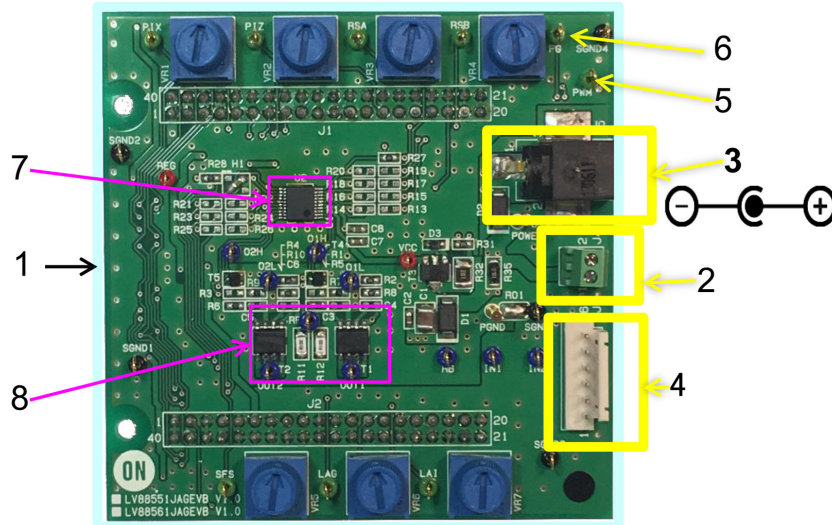

Figure 1. Connectors and key parts

Power Supply

J4 is the main power supply connector. The outputs of a power supplier will be connected to this connector. For LV885xEVB, the POWER pin voltage accepts up to 18 V. However, for LV885xEVB, POWER pin for the operation is from 24 V to 48 V.



Figure 2. Main power

J5 is an optional connector for a power supply. Low power is assumed (less than 4A).

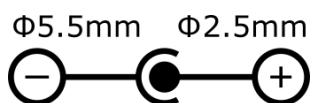

Figure 3. Power Connector Polarity

Motor

J3 is the motor connector.

Pin#	Silk label	Connected to
1	OUT2	Motor winding 2
2	OUT2	Motor winding 1
3	IN2	Hall signal +
4	IN1	Hall signal -
5	GND	Ground
6	HB	Hall bias

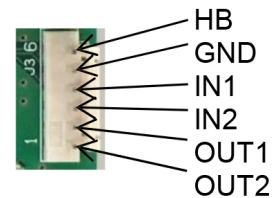

Figure 4. J3 Motor Connector

LV885XXJA-GEVB

Hall sensor or Hall IC

These devices need a Hall sensor or Hall IC to detect the commutation timing. IN1 and IN2 pins are Hall signal input pins. This EVB has Hall sensor and in this case, the resistor R38–R40 should be “OPEN”. However, in case of using Hall IC, they should be 10 kΩ.

This EVB can use for evaluation at stand-alone state. The AD converter parameters (assigned to the pins; RSA, RSB, PIX, PIZ, LAI, LAG, SFS), can be set by either analog potentiometers or register dividers. The following table shows resistor and jumper setting combination.

Parameter setting

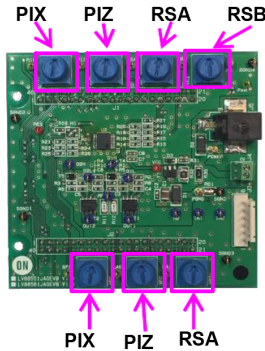

Table 2.

Parameter	Resistor and Jumper	Potentiometer	Fixed resistor divider	Digital potentiometer IC (Note 1)
PIX	R13	Open	Resistor	Open
	R14	Open	Resistor	Open
	RO2	Short	Open	Open
	RO4	Open	Open	Short
PIZ	R15	Open	Resistor	Open
	R16	Open	Resistor	Open
	RO5	Short	Open	Open
	RO7	Open	Open	Short
RSA	R17	Open	Resistor	Open
	R18	Open	Resistor	Open
	RO8	Short	Open	Open
	RO9	Open	Open	Short
RSB	R19	Open	Resistor	Open
	R20	Open	Resistor	Open
	RO10	Short	Open	Open
	RO12	Open	Open	Short
SFS	R21	Open	Resistor	Open
	R22	Open	Resistor	Open
	RO13	Short	Open	Open
	RO14	Open	Open	Short
LAG	R23	Open	Resistor	Open
	R24	Open	Resistor	Open
	RO15	Short	Open	Open
	RO17	Open	Open	Short

LV885XXJA-GEVB

Table 2.

Parameter	Resistor and Jumper	Potentiometer	Fixed resistor divider	Digital potentiometer IC (Note 1)
LAI	R25	Open	Resistor	Open
	R26	Open	Resistor	Open
	RO18	Short	Open	Open
	RO20	Open	Open	Short

1. Not supported in this version
2. RO3, RO6, RO11, RO16 and RO19 are for "ON INTERNAL USE", and are kept "Open".

TYPICAL OPERATION

Overall tuning procedure

1. Setup fan, power supply, pulse generator (for PWM duty cycle input)
2. Set setting pin voltage with either potentiometer or resistor pair
3. Turn-on power supply
4. Evaluate motor
5. Repeat from step 2, until appropriate evaluation result obtained

The configuration is loaded right after power-on from off. Therefore, power off/on cycle is required every time the parameters are changed.

Waveform example

Below is the example waveform of LV88561JA with various Lead Angle Settings.

The EVB condition is;

- VIN = 48 V
- 2000 RPM setting (PWM = 100%)

Lead Angle setting (LAG; 0 deg., LAI ; 0 deg.)

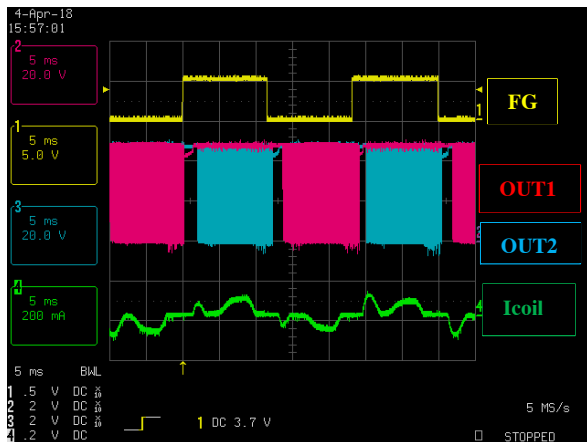

Lead Angle setting (LAG; +9.975 deg., LAI ; 0 deg.)

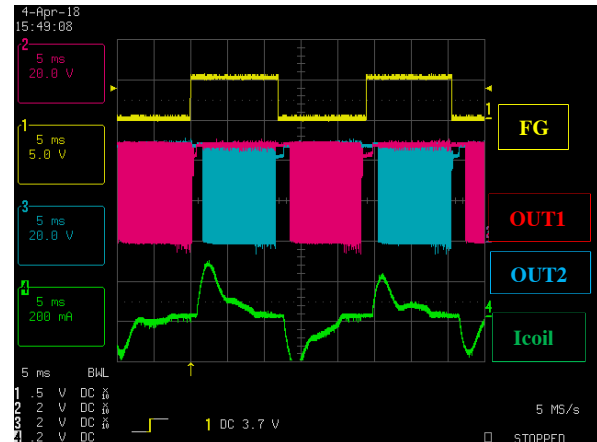

Lead Angle setting (LAG; -9.975 deg., LAI ; 0 deg.)

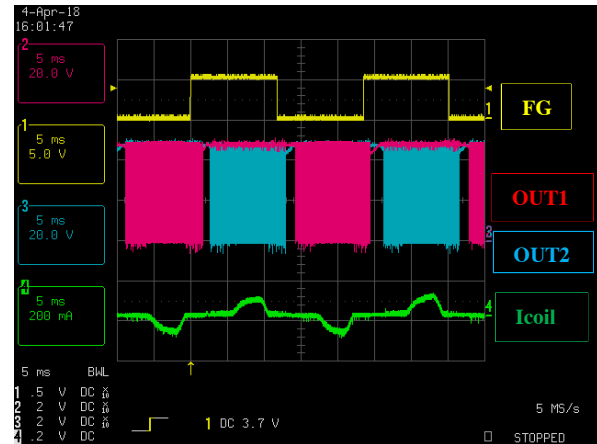

Figure 5. Demonstration Board Solution

ON Semiconductor and the ON Semiconductor logo are trademarks of Semiconductor Components Industries, LLC dba ON Semiconductor or its subsidiaries in the United States and/or other countries. ON Semiconductor owns the rights to a number of patents, trademarks, copyrights, trade secrets, and other intellectual property. A listing of ON Semiconductor's product/patent coverage may be accessed at www.onsemi.com/site/pdf/Patent-Marking.pdf. ON Semiconductor is an Equal Opportunity/Affirmative Action Employer. This literature is subject to all applicable copyright laws and is not for resale in any manner.

The evaluation board/kit (research and development board/kit) (hereinafter the "board") is not a finished product and is as such not available for sale to consumers. The board is only intended for research, development, demonstration and evaluation purposes and should as such only be used in laboratory/development areas by persons with an engineering/technical training and familiar with the risks associated with handling electrical/mechanical components, systems and subsystems. This person assumes full responsibility/liability for proper and safe handling. Any other use, resale or redistribution for any other purpose is strictly prohibited.

The board is delivered "AS IS" and without warranty of any kind including, but not limited to, that the board is production-worthy, that the functions contained in the board will meet your requirements, or that the operation of the board will be uninterrupted or error free. ON Semiconductor expressly disclaims all warranties, express, implied or otherwise, including without limitation, warranties of fitness for a particular purpose and non-infringement of intellectual property rights.

ON Semiconductor reserves the right to make changes without further notice to any board.

You are responsible for determining whether the board will be suitable for your intended use or application or will achieve your intended results. Prior to using or distributing any systems that have been evaluated, designed or tested using the board, you agree to test and validate your design to confirm the functionality for your application. Any technical, applications or design information or advice, quality characterization, reliability data or other services provided by ON Semiconductor shall not constitute any representation or warranty by ON Semiconductor, and no additional obligations or liabilities shall arise from ON Semiconductor having provided such information or services.

The boards are not designed, intended, or authorized for use in life support systems, or any FDA Class 3 medical devices or medical devices with a similar or equivalent classification in a foreign jurisdiction, or any devices intended for implantation in the human body. Should you purchase or use the board for any such unintended or unauthorized application, you shall indemnify and hold ON Semiconductor and its officers, employees, subsidiaries, affiliates, and distributors harmless against all claims, costs, damages, and expenses, and reasonable attorney fees arising out of, directly or indirectly, any claim of personal injury or death associated with such unintended or unauthorized use, even if such claim alleges that ON Semiconductor was negligent regarding the design or manufacture of the board.

This evaluation board/kit does not fall within the scope of the European Union directives regarding electromagnetic compatibility, restricted substances (RoHS), recycling (WEEE), FCC, CE or UL, and may not meet the technical requirements of these or other related directives.

FCC WARNING – This evaluation board/kit is intended for use for engineering development, demonstration, or evaluation purposes only and is not considered by ON Semiconductor to be a finished end product fit for general consumer use. It may generate, use, or radiate radio frequency energy and has not been tested for compliance with the limits of computing devices pursuant to part 15 of FCC rules, which are designed to provide reasonable protection against radio frequency interference. Operation of this equipment may cause interference with radio communications, in which case the user shall be responsible, at its expense, to take whatever measures may be required to correct this interference.

ON Semiconductor does not convey any license under its patent rights nor the rights of others.

LIMITATIONS OF LIABILITY: ON Semiconductor shall not be liable for any special, consequential, incidental, indirect or punitive damages, including, but not limited to the costs of requalification, delay, loss of profits or goodwill, arising out of or in connection with the board, even if ON Semiconductor is advised of the possibility of such damages. In no event shall ON Semiconductor's aggregate liability from any obligation arising out of or in connection with the board, under any theory of liability, exceed the purchase price paid for the board, if any.

For more information and documentation, please visit www.onsemi.com.

PUBLICATION ORDERING INFORMATION

LITERATURE FULFILLMENT:

Email Requests to: orderlit@onsemi.com

ON Semiconductor Website: www.onsemi.com

TECHNICAL SUPPORT

North American Technical Support:

Voice Mail: 1 800-282-9855 Toll Free USA/Canada

Phone: 011 421 33 790 2910

Europe, Middle East and Africa Technical Support:

Phone: 00421 33 790 2910

For additional information, please contact your local Sales Representative