

Data sheet

Commercial Art.No.: 25.352.3753.0

PCB pin header 8213 S / 7 W OB

PCB pin header, connection method depends on used socket part , 7 poles, pitch: 5.08 mm, type of packing: carton, color: grey



Certificates / Approvals



Technical data

General

Modular spacing	5.08 mm
Soldering process	Wave soldering
Packaging	Carton
Number of poles	7
Number of levels	1
Marking	No
Fastening	None
Mating direction towards (circuit) board	180°

Technical data

Rated current	12 A
Overvoltage Category I	1000 V
Overvoltage Category II	400 V
Overvoltage Category III	250 V
Rated impulse voltage	4 kV

Technical Data UL/CSA

Voltage UL	300 V
Current field wiring	15 A
Current factory wiring	15 A
Voltage CSA	300 V
Current CSA	15 A

Other

Type of insulation material	Thermoplastic
Color	Grey
Height	8.4 mm
Length	36.96 mm
Depth	12 mm
Material contact base	CuZn
Material contact surface	Sn

Classification

ECLASS 11	
ECLASS 8.1	27440402
ETIM 7.0	EC002637
ETIM 6.0	EC002637
ETIM 5.0	EC002637
ETIM 4.0	EC002637

Product compliance

ROHS conformity status	Compliant
REACH-SVHC conformity status	Compliant

These dimensions will be especially checked at delivery
 Only inspection dimensions
 With /E marked dimensions are only valid for internal use

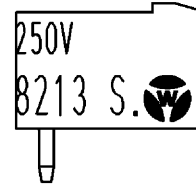
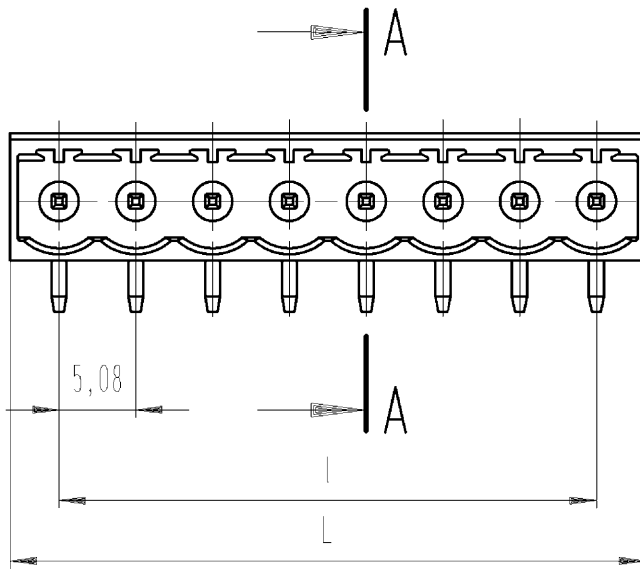

Weitergabe sowie Vervielfältigung dieses Dokuments, Verwertung und Mitteilung seines Inhalts sind verboten, soweit nicht ausdrücklich gestattet. Die Reproduktion, Distribution und Utilization of this document as well as the communication of its contents to others without authorization is prohibited.

Schnitt A-A
 section A-A

gezeichnete Ausführung 8-polig
 drawn version 8 poles

Weitere Daten siehe Katalog
 further data see catalog

Diese Maße werden bei Abnahme besonders geprüft
 Ausschließlich Prüfmaße
 Mit /E gekennzeichnete Maße sind nur für interne Zwecke gültig

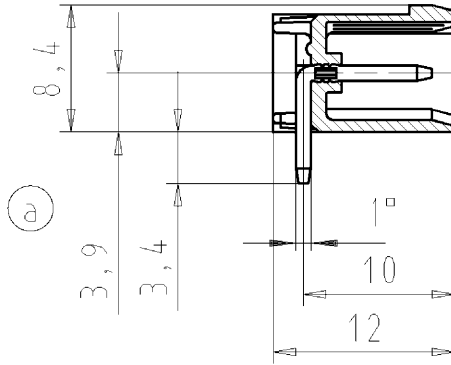

Farbe / colour	.F
grau / grey	.0
schwarz / black	.1
grün / green	.7
orange	.9

Teile-Nr. part no.	Pol- zahl pole	L	l	Typ type	Teile-Nr. part no.	Pol- zahl pole	L	l	Typ type
25.352.3253.F	2	11,56	5,08	8213S / 2W OB	25.352.4353.F	13	67,44	60,96	8213S /13W OB
25.352.3353.F	3	16,64	10,16	8213S / 3W OB	25.352.4453.F	14	72,52	66,04	8213S /14W OB
25.352.3453.F	4	21,72	15,24	8213S / 4W OB	25.352.4553.F	15	77,60	71,12	8213S /15W OB
25.352.3553.F	5	26,80	20,32	8213S / 5W OB	25.352.4653.F	16	82,68	76,20	8213S /16W OB
25.352.3653.F	6	31,88	25,40	8213S / 6W OB	25.352.4753.F	17	87,76	81,28	8213S /17W OB
25.352.3753.F	7	36,96	30,48	8213S / 7W OB	25.352.4853.F	18	92,84	86,36	8213S /18W OB
25.352.3853.F	8	42,04	35,56	8213S / 8W OB	25.352.4953.F	19	97,92	91,44	8213S /19W OB
25.352.3953.F	9	47,12	40,64	8213S / 9W OB	25.352.5053.F	20	103,00	96,52	8213S /20W OB
25.352.4053.F	10	52,20	45,72	8213S /10W OB	25.352.5153.F	21	108,08	101,60	8213S /21W OB
25.352.4153.F	11	57,28	50,80	8213S /11W OB	25.352.5253.F	22	113,16	106,68	8213S /22W OB
25.352.4253.F	12	62,36	55,88	8213S /12W OB	25.352.5353.F	23	118,24	111,76	8213S /23W OB
					25.352.5453.F	24	123,32	116,84	8213S /24W OB

Zulässige Abweichungen nach DIN 7167/Permissible deviations acc. to DIN 7167.
 (This DIN-standard describes the envelope principle. According to the envelope principle the deviations of form and parallelism are limited by the size tolerances).

ja/yes Stoffverbots- und Deklarationsliste nach UU-TQM-05/03 ist einzuhalten.
 Conformity with Wieland document UU-TQM-05/03 (list of prohibited / declarable hazardous substances) to be declared!

Freitoleranz nach General tolerance CAD - Zeichnung, keine manuellen Änderungen CAD - drawing, no manual modifications allowed I.Verwendung: First Use: Blatt: 1 von 1 Sheet: of 1

Werkstoff/Material	2005	Tag/Date	Name	Zeichnung Nr./Drawing No.	Index
	gezeichnet drawn	28.07.	Schnitt J.	T 25.352.3253.0 01K	a
	geprüft checked	-	-	Maße in mm/Dimensions are in mm	
	Normgepr. Stand., check	-	-		

Vol.	mm ³	Dfl./Surf.	mm ²	Ersatz für/Replacement for: -
				Type
				Benennung/Titile
				LP_GEHAEUSESTIFTLEISTE
				Rastermaß 5,08 / pitch 5,08
				PCB header