

Data sheet

Commercial Art.No.: 25.220.3453.0

PCB connector 8113 B / 4 TOP OB

PCB female connector with front/top screw connection, 4 poles, max. cross section: 2.5 mm², pitch: 5 mm, type of packing: carton, color: grey

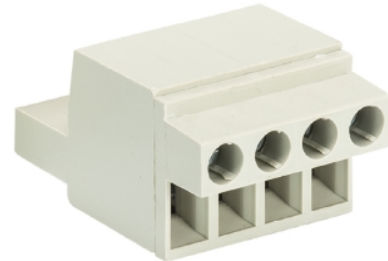

Commercial Art.No.	25.220.3453.0
EAN	4015573179745
Order Unit	50

Certificates / Approvals



Technical data

General

Modular spacing	5 mm
Connection type	Screw connection
Soldering process	None
Packaging	Carton
Number of poles	4
Marking	No
Fastening	None
Mating direction towards connector	180°

Technical data

Nominal cross section	2.5 mm ²
Rated current	12 A
Overvoltage Category I	1000 V
Overvoltage Category II	400 V
Overvoltage Category III	250 V
Rated impulse voltage	4 kV
Wire strip length	9.5 mm

Connection Data

Minimum cross section solid	0.2 mm ²
Maximum cross section solid	2.5 mm ²
Minimum cross section fine stranded	1.5 mm ²
Maximum cross section fine stranded	2.5 mm ²
Wire strip length	9.5 mm

Technical Data UL/CSA

Cross section UL	30-12 AWG
Voltage UL	300 V
Current field wiring	15 A
Current factory wiring	15 A
Cross section CSA	22-12 AWG
Voltage CSA	300 V
Current CSA	15 A

Other

Type of insulation material	Thermoplastic
Color	Grey
Height	15 mm
Length	20 mm
Depth	29 mm
Material attachment screw	Steel
Material contact base	CuSn
Material contact surface	Sn

Classification

ECLASS 11	
ECLASS 8.1	27440402
ETIM 7.0	EC002637
ETIM 6.0	EC002637
ETIM 5.0	EC002637
ETIM 4.0	EC002637

Product compliance

ROHS conformity status	Compliant
REACH-SVHC conformity status	Compliant

Gezeichnete Ausführung: 10 polig
drawn version : 10-poles

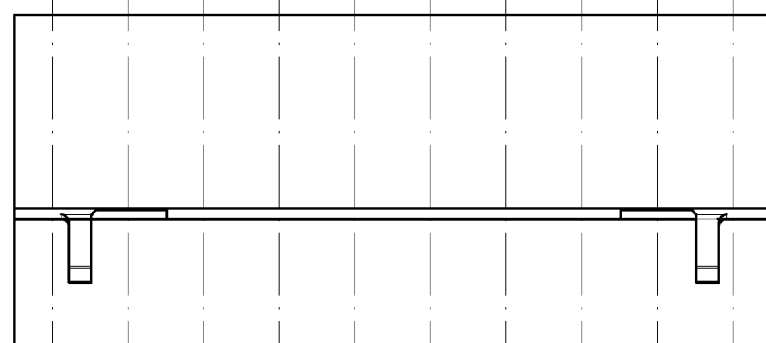
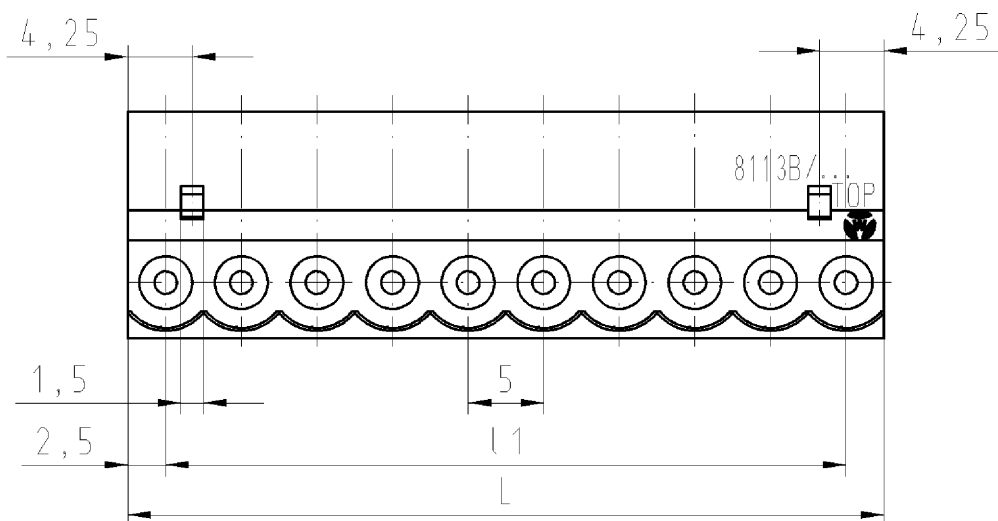
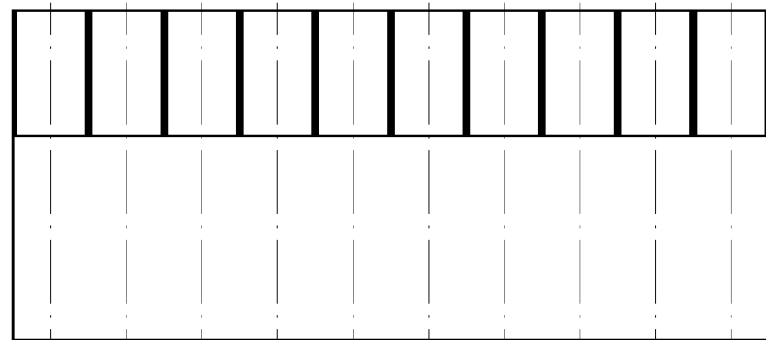

Schnitt A-A
selection A-A

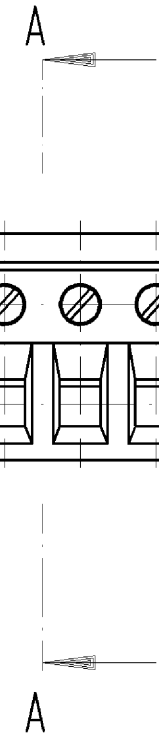
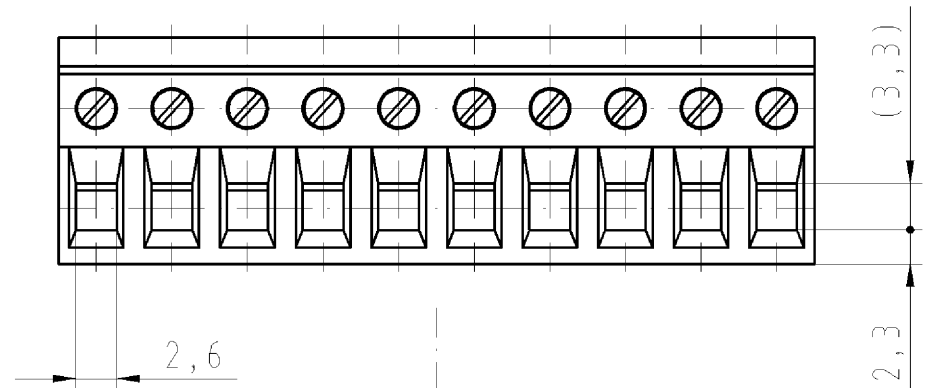
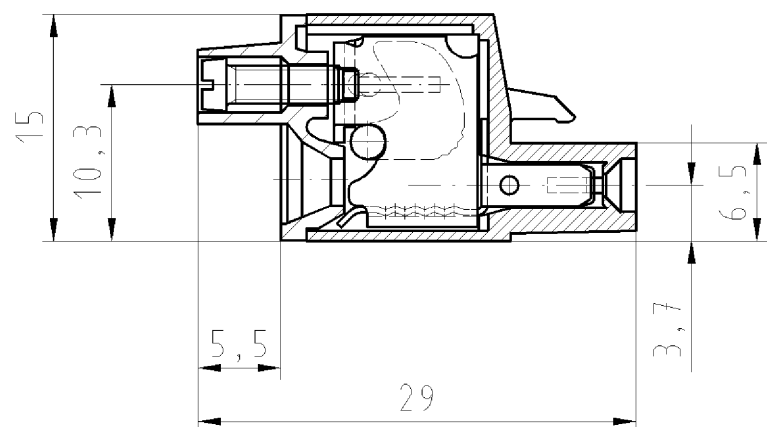

Weitere Daten siehe Katalog
further data see catalog

Teile-Nr. part number	Pol-Z pole	L	l1	Typ type
25.220.4253.0	12	60	55	8113 B/12TOP OB
25.220.4153.0	11	55	50	8113 B/11TOP OB
25.220.4053.0	10	50	45	8113 B/10TOP OB
25.220.3953.0	09	45	40	8113 B/ 9TOP OB
25.220.3853.0	08	40	35	8113 B/ 8TOP OB
25.220.3753.0	07	35	30	8113 B/ 7TOP OB
25.220.3653.0	06	30	25	8113 B/ 6TOP OB
25.220.3553.0	05	25	20	8113 B/ 5TOP OB
25.220.3453.0	04	20	15	8113 B/ 4TOP OB
25.220.3353.0	03	15	10	8113 B/ 3TOP OB
25.220.3253.0	02	10	05	8113 B/ 2TOP OB

Teile-Nr. part number	Pol-Z pole	L	l1	Typ type
25.220.5453.0	24	120	115	8113 B/24TOP OB
25.220.5353.0	23	115	110	8113 B/23TOP OB
25.220.5253.0	22	110	105	8113 B/22TOP OB
25.220.5153.0	21	105	100	8113 B/21TOP OB
25.220.5053.0	20	100	95	8113 B/20TOP OB
25.220.4953.0	19	95	90	8113 B/19TOP OB
25.220.4853.0	18	90	85	8113 B/18TOP OB
25.220.4753.0	17	85	80	8113 B/17TOP OB
25.220.4653.0	16	80	75	8113 B/16TOP OB
25.220.4553.0	15	75	70	8113 B/15TOP OB
25.220.4453.0	14	70	65	8113 B/14TOP OB
25.220.4353.0	13	65	60	8113 B/13TOP OB

Tolerierung nach DIN 7167/Tolerance system acc. to DIN 7167.
[This DIN-standard describes the envelope principle. According to the envelope principle the deviations of form and parallelism are limited by the size tolerances].

ja/yes Stoffverbots- und Deklarationsliste nach UU-TQM-05/03 ist einzuhalten.
Conformity with Wieland document UU-TQM-05/03 (list of prohibited / declarable hazardous substances) to be declared!

Freitoleranz nach General tolerance CAD - Zeichnung, keine manuellen Änderungen CAD - drawing, no manual modifications allowed 1. Verwendung: - First Use: - Blatt: 1 von 1 Sheet: of 1

gezeichnet/drawn	19.12.	Schmitt J.	T	25.220.3253.0 01K	Index
geprüft/checked	-	-			
Normgepr. Stand. check	-	-			

Maße in mm/Dimensions are in mm

Werkstoff/Material	2006	Tag/Date	Name	T	25.220.3253.0 01K
Maßstab/Scale	2:1	-	-		
Vol.	mm ³	Oil./Surf.	mm ²	Ersatz für/Replacement for: -	
wieland			Type	Benennung/Title	
Elektrische Verbindungen			LP_STECKKLEMME		
Änderung/Revision			Rastmaß 5 / pitch 5 Pluggable PCB terminal		

These dimensions will be especially checked at delivery
Only inspection dimensions
With /E marked dimensions are only valid for internal use

Diese Maße werden bei Abnahme besonders geprüft
Ausschließlich Prüfmaße
Mit /E gekennzeichnete Maße sind nur für interne Zwecke gültig

Weitergabe sowie Vervielfältigung dieses Dokuments, Verwertung und Mitteilung seines Inhalts sind verboten, soweit nicht ausdrücklich gestattet.
The reproduction, distribution and utilization of this document as well as the communication of its contents to others without express authorization is prohibited.

252203253001K_4_CADW1042_Schnitt: 2006-12-19T11:02:19 1.000 QU-PEM-08/91