

## Data Sheet | Item Number: 231-615

1-conductor male connector; CAGE CLAMP®; 2.5 mm<sup>2</sup>; Pin spacing 5 mm; 15-pole;  
2,50 mm<sup>2</sup>; gray

<https://www.wago.com/231-615>



Color: ■ gray

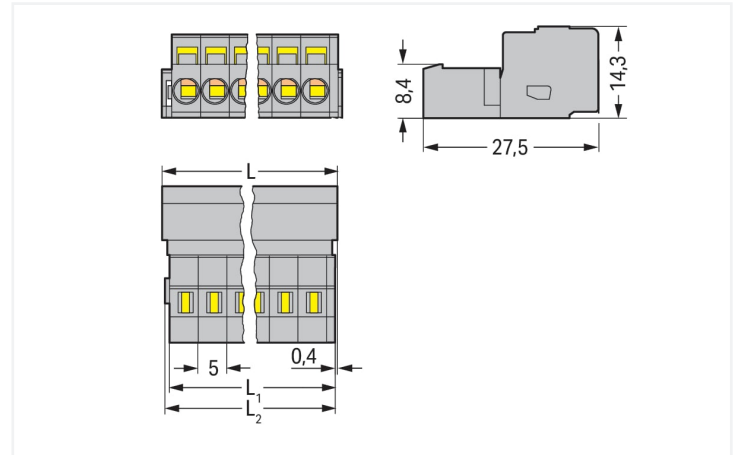

Dimensions in mm

$L = (\text{pole no.} - 1) \times \text{pin spacing} + 8.2 \text{ mm}$

$L1 = L - 1.7 \text{ mm}$

$L2 = L - 1.2 \text{ mm}$

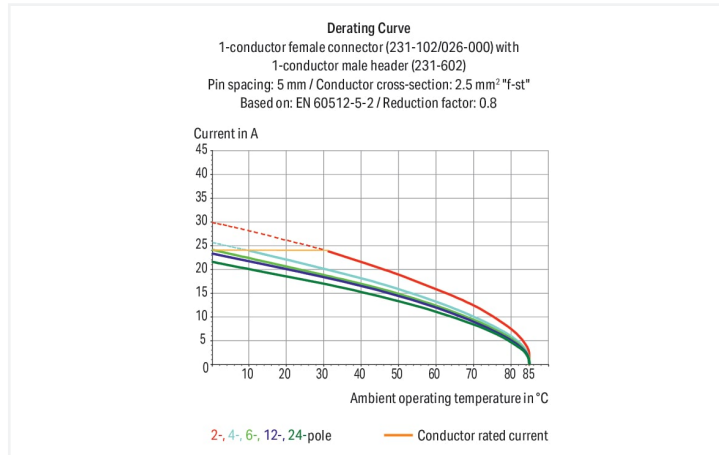

- Universal connection for all conductor types
- Easy cable pre-assembly and on-unit wiring via vertical and horizontal CAGE CLAMP® actuation
- For wire-to-wire and board-to-wire connections
- Versions available with snap-in mounting feet or flanges for panel or through-panel mounting
- With coding fingers

### Notes

#### Safety Information

The MCS – MULTI CONNECTION SYSTEM includes connectors without breaking capacity in accordance with DIN EN 61984. When used as intended, these connectors must not be connected/disconnected when live or under load. When used as intended, these connectors must not be connected/disconnected when live or under load. The circuit design should ensure header pins, which can be touched, are not live when unmated.

#### Variants:

Other versions (or variants) can be requested from WAGO Sales or configured at <https://configurator.wago.com/>.

Other pole numbers

Gold-plated or partially gold-plated contact surfaces

## Electrical data

Ratings per	IEC/EN 60664-1		
Overvoltage category	III	III	II
Pollution degree	3	2	2
Nominal voltage	320 V	320 V	630 V
Rated surge voltage	4 kV	4 kV	4 kV
Rated current	12 A	12 A	12 A

Approvals per	UL 1059		
Use group	B	C	D
Rated voltage	300 V	-	300 V
Rated current	15 A	-	10 A

Approvals per	UL 1977
Rated voltage	600 V
Rated current	15 A

Approvals per	CSA		
Use group	B	C	D
Rated voltage	300 V	-	300 V
Rated current	15 A	-	10 A

## Connection data

Clamping units	15
Total number of potentials	15
Number of connection types	1
Number of levels	1

Connection 1	
Connection technology	CAGE CLAMP®
Actuation type	Operating tool
Actuation direction 1	Operation parallel to conductor entry
Actuation direction 2	Operation perpendicular to conductor entry
Solid conductor	0.08 ... 2.5 mm <sup>2</sup> / 28 ... 12 AWG
Fine-stranded conductor	0.08 ... 2.5 mm <sup>2</sup> / 28 ... 12 AWG
Fine-stranded conductor; with insulated ferrule	0.25 ... 1.5 mm <sup>2</sup>
Fine-stranded conductor; with uninsulated ferrule	0.25 ... 2.5 mm <sup>2</sup>
Strip length	8 ... 9 mm / 0.31 ... 0.35 inches
Pole number	15
Conductor entry direction to mating direction	0°

## Physical data

Pin spacing	5 mm / 0.197 inches
Width	78.2 mm / 3.079 inches
Height	14.3 mm / 0.563 inches
Depth	27.5 mm / 1.083 inches

## Mechanical data

Variable coding	Yes
Anti-rotation protection	Yes

## Plug-in connection

Contact type (pluggable connector)	Male connector/plug
Connector (connection type)	for conductor
Mismatching protection	No

## Material data

Note (material data)	<a href="#">Information on material specifications can be found here</a>
Color	gray
Material group	I
Insulation material (main housing)	Polyamide (PA66)
Flammability class per UL94	V0
Clamping spring material	Chrome-nickel spring steel (CrNi)
Contact material	Electrolytic copper (E <sub>Cu</sub> )
Contact Plating	Tin
Fire load	0.584 MJ
Weight	22.5 g

## Environmental requirements

Limit temperature range	-60 ... +100 °C	<b>Environmental Testing (Environmental Conditions)</b>	
Processing temperature	-35 ... +60 °C	Test specification	DIN EN 50155 (VDE 0115-200):2022-06
		Railway applications – Rolling stock – Electronic equipment	
		Test procedure	DIN EN 61373 (VDE 0115-0106):2011-04
		Railway applications – Rolling stock equipment – Shock and vibration tests	
		Spectrum/Installation location	Service life test, Category 1, Class A/B
		Function test with noise-like vibration	Test passed according to Section 8 of the standard
		Frequency	f <sub>1</sub> = 5 Hz to f <sub>2</sub> = 150 Hz f <sub>1</sub> = 5 Hz to f <sub>2</sub> = 150 Hz
		Acceleration	0.101g (highest test level used for all axes) 0.572g (highest test level used for all axes) 5g (highest test level used for all axes)
		Test duration per axis	10 min. 5 h
		Test directions	X, Y and Z axes X, Y and Z axes X, Y and Z axes
		Monitoring for contact faults/interruptions	Passed
		Voltage drop measurement before and after each axis	Passed
		Simulated service life test through increased levels of noise-like vibration	Test passed according to Section 9 of the standard
		Extended test scope: Monitoring for contact faults/interruptions	Passed
		Extended test scope: Voltage drop measurement before and after each axis	Passed
		Shock test	Test passed according to Section 10 of the standard
		Shock form	Half sine
		Shock duration	30 ms
		Number of shocks per axis	3 pos. und 3 neg.
		Vibration and shock stress for rolling stock equipment	Passed

### Commercial data

Product Group	3 (Multi Conn. System)
eCl@ss 10.0	27-44-03-09
eCl@ss 9.0	27-44-03-09
ETIM 9.0	EC002638
ETIM 8.0	EC002638
PU (SPU)	25 pcs
Packaging type	Box
Country of origin	DE
GTIN	4044918258661
Customs tariff number	85366930000

### Environmental Product Compliance

RoHS Compliance Status	Compliant, No Exemption
------------------------	-------------------------

### Approvals / Certificates

#### General approvals



Approval	Standard	Certificate Name
CB DEKRA Certification B.V.	IEC 61984	NL-39756/A1
CSA DEKRA Certification B.V.	C22.2	1466354
KEMA/KEUR DEKRA Certification B.V.	EN 61984	71-121453
UR Underwriters Laboratories Inc.	UL 1977	E45171

#### Declarations of conformity and manufacturer's declarations



Approval	Standard	Certificate Name
Railway WAGO GmbH & Co. KG	-	Railway Ready

### Approvals for marine applications



Approval	Standard	Certificate Name
ABS American Bureau of Shipping	-	19-HG1869876-PDA
DNV DNV GL SE	-	TAE000016Z
LR Lloyds Register	IEC 61984	96/20035 (E5)

**Downloads**

**Environmental Product Compliance**

Compliance Search			
Environmental Product Compliance 231-615			↓

**Documentation**

Additional Information			
Technical Section	03.04.2019	pdf 2027.26 KB	↓

**CAD/CAE-Data**

CAD data	
2D/3D Models 231-615	↓

CAE data	
EPLAN Data Portal 231-615	↓
ZUKEN Portal 231-615	↓

**1 Compatible Products**

**1.1 System counterpart**

**1.1.1 Female connector/socket**

<p><b>Item No.: 232-115/026-000</b> 1-conductor female connector, angled; CAGE CLAMP®; 2.5 mm²; Pin spacing 5 mm; 15-pole; 2,50 mm²; gray</p>	<p><b>Item No.: 232-215/026-000</b> 1-conductor female connector, angled; CAGE CLAMP®; 2.5 mm²; Pin spacing 5 mm; 15-pole; 2,50 mm²; gray</p>	<p><b>Item No.: 731-515/031-000</b> 1-conductor female connector, angled; CAGE CLAMP®; 2.5 mm²; Pin spacing 5 mm; 15-pole; clamping collar; DIN-35 rail/ panel mounting; 2,50 mm²; gray</p>	<p><b>Item No.: 731-515/008-000</b> 1-conductor female connector, angled; CAGE CLAMP®; 2.5 mm²; Pin spacing 5 mm; 15-pole; Snap-in mounting feet; 2,50 mm²; gray</p>
<p><b>Item No.: 231-115/026-000</b> 1-conductor female connector; CAGE CLAMP®; 2.5 mm²; Pin spacing 5 mm; 15-pole; 2,50 mm²; gray</p>	<p><b>Item No.: 231-115/027-000</b> 1-conductor female connector; CAGE CLAMP®; 2.5 mm²; Pin spacing 5 mm; 15-pole; clamping collar; 2,50 mm²; gray</p>	<p><b>Item No.: 231-115/031-000</b> 1-conductor female connector; CAGE CLAMP®; 2.5 mm²; Pin spacing 5 mm; 15-pole; clamping collar; 2,50 mm²; gray</p>	<p><b>Item No.: 231-115/026-000/054-000</b> 1-conductor female connector; CAGE CLAMP®; 2.5 mm²; Pin spacing 5 mm; 15-pole; direct marking; 2,50 mm²; gray</p>
<p><b>Item No.: 231-115/037-000</b> 1-conductor female connector; CAGE CLAMP®; 2.5 mm²; Pin spacing 5 mm; 15-pole; Lateral locking levers; 2,50 mm²; gray</p>	<p><b>Item No.: 231-115/125-000</b> 1-conductor female connector; CAGE CLAMP®; 2.5 mm²; Pin spacing 5 mm; 15-pole; Snap-in flange; 2,50 mm²; gray</p>	<p><b>Item No.: 231-115/008-000</b> 1-conductor female connector; CAGE CLAMP®; 2.5 mm²; Pin spacing 5 mm; 15-pole; Snap-in mounting feet; 2,50 mm²; gray</p>	<p><b>Item No.: 231-115/102-000</b> 1-conductor female connector; CAGE CLAMP®; 2.5 mm²; Pin spacing 5 mm; 15-pole; with integrated end plate; 2,50 mm²; gray</p>
<p><b>Item No.: 2231-115/026-000</b> 1-conductor female connector; push-button; Push-in CAGE CLAMP®; 2.5 mm²; Pin spacing 5 mm; 15-pole; 2,50 mm²; gray</p>	<p><b>Item No.: 2231-115/031-000</b> 1-conductor female connector; push-button; Push-in CAGE CLAMP®; 2.5 mm²; Pin spacing 5 mm; 15-pole; clamping collar; 2,50 mm²; gray</p>	<p><b>Item No.: 2231-115/037-000</b> 1-conductor female connector; push-button; Push-in CAGE CLAMP®; 2.5 mm²; Pin spacing 5 mm; 15-pole; Lateral locking levers; 2,50 mm²; gray</p>	<p><b>Item No.: 2231-115/008-000</b> 1-conductor female connector; push-button; Push-in CAGE CLAMP®; 2.5 mm²; Pin spacing 5 mm; 15-pole; Snap-in mounting feet; 2,50 mm²; gray</p>

### 1.1.1 Female connector/socket



**Item No.: 2231-115/102-000**

1-conductor female connector; push-button; Push-in CAGE CLAMP®; 2.5 mm²; Pin spacing 5 mm; 15-pole; with integrated end plate; 2,50 mm²; gray



**Item No.: 231-2115/037-000**

2-conductor female connector; Push-in CAGE CLAMP®; 2.5 mm²; Pin spacing 5 mm; 15-pole; Lateral locking levers; 2,50 mm²; gray



**Item No.: 231-2115/026-000**

2-conductor female connector; Push-in CAGE CLAMP®; 2.5 mm²; Pin spacing 5 mm; 15-pole; with integrated end plate; 2,50 mm²; gray



**Item No.: 232-245/005-000/039-000**

Female connector for rail-mount terminal blocks; 0.6 x 1 mm pins; angled; Locking lever; Pin spacing 5 mm; 15-pole; gray



**Item No.: 232-245/005-000**

Female connector for rail-mount terminal blocks; 0.6 x 1 mm pins; angled; Pin spacing 5 mm; 15-pole; gray



**Item No.: 232-145/005-000/039-000**

Female connector for rail-mount terminal blocks; 0.6 x 1 mm pins; straight; Locking lever; Pin spacing 5 mm; 15-pole; gray



**Item No.: 232-145/005-000**

Female connector for rail-mount terminal blocks; 0.6 x 1 mm pins; straight; Pin spacing 5 mm; 15-pole; gray



**Item No.: 232-245**

THT female header; angled; Pin spacing 5 mm; 15-pole; 0.6 x 1.0 mm solder pin; gray



**Item No.: 232-245/031-000**

THT female header; angled; Pin spacing 5 mm; 15-pole; clamping collar; 0.6 x 1.0 mm solder pin; gray



**Item No.: 232-245/039-000**

THT female header; angled; Pin spacing 5 mm; 15-pole; Locking lever; 0.6 x 1.0 mm solder pin; gray



**Item No.: 232-245/047-000**

THT female header; angled; Pin spacing 5 mm; 15-pole; Spacer flange; 0.6 x 1.0 mm solder pin; gray



**Item No.: 232-145**

THT female header; straight; Pin spacing 5 mm; 15-pole; 0.6 x 1.0 mm solder pin; gray



**Item No.: 232-145/031-000**

THT female header; straight; Pin spacing 5 mm; 15-pole; clamping collar; 0.6 x 1.0 mm solder pin; gray



**Item No.: 232-145/039-000**

THT female header; straight; Pin spacing 5 mm; 15-pole; Locking lever; 0.6 x 1.0 mm solder pin; gray



**Item No.: 232-145/047-000**

THT female header; straight; Pin spacing 5 mm; 15-pole; Spacer flange; 0.6 x 1.0 mm solder pin; gray

### 1.2 Optional Accessories

#### 1.2.1 Coding

##### 1.2.1.1 Coding



**Item No.: 231-129**

Coding key; snap-on type; light gray

#### 1.2.2 Cover

##### 1.2.2.1 Cover



**Item No.: 231-668**

Lockout caps; for covering unused clamping units; gray

#### 1.2.3 Ferrule

##### 1.2.3.1 Ferrule



**Item No.: 216-301**

Ferrule; Sleeve for 0.25 mm² / AWG 24; insulated; electro-tin plated; yellow



**Item No.: 216-302**

Ferrule; Sleeve for 0.34 mm² / 22 AWG; insulated; electro-tin plated; light turquoise



**Item No.: 216-241**

Ferrule; Sleeve for 0.5 mm² / 20 AWG; insulated; electro-tin plated; electrolytic copper; gastight crimped; acc. to DIN 46228, Part 4/09.90; white



**Item No.: 216-201**



Ferrule; Sleeve for 0.5 mm² / 20 AWG; insulated; electro-tin plated; white

1.2.3.1 Ferrule

 <b>Item No.: 216-141</b> Ferrule; Sleeve for 0.5 mm <sup>2</sup> / 20 AWG; un-insulated; electro-tin plated; electrolytic copper; gastight crimped; acc. to DIN 46228, Part 1/08.92	 <b>Item No.: 216-101</b> Ferrule; Sleeve for 0.5 mm <sup>2</sup> / AWG 22; un-insulated; electro-tin plated; silver-colored	 <b>Item No.: 216-242</b> Ferrule; Sleeve for 0.75 mm <sup>2</sup> / 18 AWG; insulated; electro-tin plated; electrolytic copper; gastight crimped; acc. to DIN 46228, Part 4/09.90; gray	 <b>Item No.: 216-262</b> Ferrule; Sleeve for 0.75 mm <sup>2</sup> / 18 AWG; insulated; electro-tin plated; electrolytic copper; gastight crimped; acc. to DIN 46228, Part 4/09.90; gray
 <b>Item No.: 216-202</b> Ferrule; Sleeve for 0.75 mm <sup>2</sup> / 18 AWG; insulated; electro-tin plated; gray	 <b>Item No.: 216-142</b> Ferrule; Sleeve for 0.75 mm <sup>2</sup> / 18 AWG; un-insulated; electro-tin plated; electrolytic copper; gastight crimped; acc. to DIN 46228, Part 1/08.92	 <b>Item No.: 216-102</b> Ferrule; Sleeve for 0.75 mm <sup>2</sup> / AWG 20; un-insulated; electro-tin plated; silver-colored	 <b>Item No.: 216-243</b> Ferrule; Sleeve for 1 mm <sup>2</sup> / AWG 18; insulated; electro-tin plated; electrolytic copper; gastight crimped; acc. to DIN 46228, Part 4/09.90; red
 <b>Item No.: 216-263</b> Ferrule; Sleeve for 1 mm <sup>2</sup> / AWG 18; insulated; electro-tin plated; electrolytic copper; gastight crimped; acc. to DIN 46228, Part 4/09.90; red	 <b>Item No.: 216-203</b> Ferrule; Sleeve for 1 mm <sup>2</sup> / AWG 18; insulated; electro-tin plated; red	 <b>Item No.: 216-103</b> Ferrule; Sleeve for 1 mm <sup>2</sup> / AWG 18; un-insulated; electro-tin plated	 <b>Item No.: 216-143</b> Ferrule; Sleeve for 1 mm <sup>2</sup> / AWG 18; un-insulated; electro-tin plated; electrolytic copper; gastight crimped; acc. to DIN 46228, Part 1/08.92
 <b>Item No.: 216-204</b> Ferrule; Sleeve for 1.5 mm <sup>2</sup> / AWG 16; insulated; electro-tin plated; black	 <b>Item No.: 216-244</b> Ferrule; Sleeve for 1.5 mm <sup>2</sup> / AWG 16; insulated; electro-tin plated; electrolytic copper; gastight crimped; acc. to DIN 46228, Part 4/09.90; black	 <b>Item No.: 216-264</b> Ferrule; Sleeve for 1.5 mm <sup>2</sup> / AWG 16; insulated; electro-tin plated; electrolytic copper; gastight crimped; acc. to DIN 46228, Part 4/09.90; black	 <b>Item No.: 216-284</b> Ferrule; Sleeve for 1.5 mm <sup>2</sup> / AWG 16; insulated; electro-tin plated; electrolytic copper; gastight crimped; acc. to DIN 46228, Part 4/09.90; black
 <b>Item No.: 216-144</b> Ferrule; Sleeve for 1.5 mm <sup>2</sup> / AWG 16; un-insulated; electro-tin plated; electrolytic copper; gastight crimped; acc. to DIN 46228, Part 1/08.92; silver-colored	 <b>Item No.: 216-104</b> Ferrule; Sleeve for 1.5 mm <sup>2</sup> / AWG 16; un-insulated; electro-tin plated; silver-colored	 <b>Item No.: 216-106</b> Ferrule; Sleeve for 2.5 mm <sup>2</sup> / AWG 14; un-insulated; electro-tin plated; silver-colored	





1.2.4 Insulation stop

1.2.4.1 Insulation stop

 <b>Item No.: 231-670</b> Insulation stop; 0.08-0.2 mm <sup>2</sup> / 0.2 mm <sup>2</sup> "s"; white	 <b>Item No.: 231-671</b> Insulation stop; 0.25 - 0.5 mm <sup>2</sup> ; light gray	 <b>Item No.: 231-672</b> Insulation stop; 0.75 - 1 mm <sup>2</sup> ; dark gray
---	---	--

1.2.5 Jumper

1.2.5.1 Jumper

 <b>Item No.: 231-910</b> Jumper; for conductor entry; 10-way; insulated; gray	 <b>Item No.: 231-902</b> Jumper; for conductor entry; 2-way; insulated; gray	 <b>Item No.: 231-903</b> Jumper; for conductor entry; 3-way; insulated; gray	 <b>Item No.: 231-905</b> Jumper; for conductor entry; 5-way; insulated; gray
 <b>Item No.: 231-907</b> Jumper; for conductor entry; 7-way; insulated; gray			

## 1.2.6 Marking

### 1.2.6.1 Marking strip



**Item No.: 210-331/500-103**

Marking strips; as a DIN A4 sheet; MARKED; 1-12 (300x); Height of marker strip: 2.3 mm/0.091 in; Strip length 182 mm; Horizontal marking; Self-adhesive; white



**Item No.: 210-332/500-202**

Marking strips; as a DIN A4 sheet; MARKED; 1-16 (160x); Height of marker strip: 3 mm; Strip length 182 mm; Horizontal marking; Self-adhesive; white



**Item No.: 210-332/500-205**

Marking strips; as a DIN A4 sheet; MARKED; 1-32 (80x); Height of marker strip: 3 mm; Strip length 182 mm; Horizontal marking; Self-adhesive; white



**Item No.: 210-331/500-104**

Marking strips; as a DIN A4 sheet; MARKED; 13-24 (300x); Height of marker strip: 2.3 mm/0.091 in; Strip length 182 mm; Horizontal marking; Self-adhesive; white



**Item No.: 210-332/500-204**

Marking strips; as a DIN A4 sheet; MARKED; 17-32 (160x); Height of marker strip: 3 mm; Strip length 182 mm; Horizontal marking; Self-adhesive; white



**Item No.: 210-332/500-206**

Marking strips; as a DIN A4 sheet; MARKED; 33-48 (160x); Height of marker strip: 3 mm; Strip length 182 mm; Horizontal marking; Self-adhesive; white

## 1.2.7 Tool

### 1.2.7.1 Operating tool



**Item No.: 231-231**

Combination operating tool; red



**Item No.: 210-720**

Operating tool; Blade: 3.5 x 0.5 mm; with a partially insulated shaft; multicoloured



**Item No.: 210-657**

Operating tool; Blade: 3.5 x 0.5 mm; with a partially insulated shaft; short; multicoloured



**Item No.: 209-132**

Operating tool; for connecting comb-style jumper bar; made of insulating material; 2-way; natural



**Item No.: 210-250**

Operating tool; for MCS MINI and MIDI with CAGE CLAMP® connection; red



**Item No.: 280-440**

Operating tool; made of insulating material; 10-way; white



**Item No.: 209-130**

Operating tool; made of insulating material; 1-way; for 264 Series (1-/2-way), 280, 281 Series (up to 3-way); natural



**Item No.: 231-291**

Operating tool; made of insulating material; 1-way; loose; red



**Item No.: 231-131**

Operating tool; made of insulating material; 1-way; loose; white



**Item No.: 280-432**

Operating tool; made of insulating material; 2-way; white



**Item No.: 280-433**

Operating tool; made of insulating material; 3-way; white



**Item No.: 280-434**

Operating tool; made of insulating material; 4-way; white



**Item No.: 280-435**

Operating tool; made of insulating material; 5-way; gray



**Item No.: 280-436**

Operating tool; made of insulating material; 6-way; white



**Item No.: 280-437**

Operating tool; made of insulating material; 7-way; white



**Item No.: 280-438**

Operating tool; made of insulating material; 8-way; white



**Item No.: 231-159**

Operating tool; natural

## Installation Notes

### Conductor termination

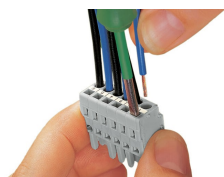

Inserting a conductor via 3.5 mm screwdriver – CAGE CLAMP® actuation parallel to conductor entry.

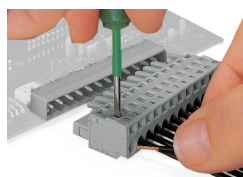

Inserting a conductor via 3.5 mm screwdriver – CAGE CLAMP® actuation perpendicular to conductor entry.



Inserting a conductor into CAGE CLAMP® unit via operating tool (231-291).



Inserting a conductor via operating tool.



## Coding

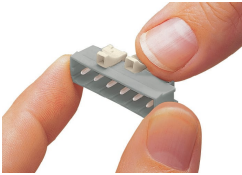

Coding a male header – fitting coding key (s).

## Testing

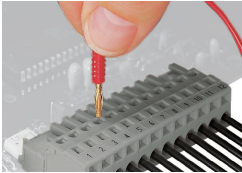

Testing – female connector with CAGE CLAMP®  
Integrated test ports for testing perpendicular to conductor entry via 2 or 2.3 mm Ø test plug

## Installation

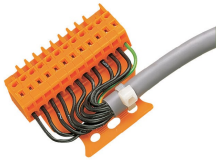

Male connector with strain relief plate



Strain relief housing shown with a male connector equipped with CAGE CLAMP®

## Marking

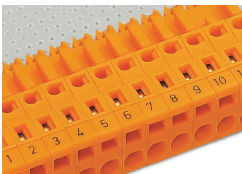

Labeling via direct marking or self-adhesive strips.