

Data Sheet | Item Number: 2092-1129

1-conductor female connector; push-button; Push-in CAGE CLAMP®; 2.5 mm²; Pin spacing 5 mm; 9-pole; 2,50 mm²; light gray

<https://www.wago.com/2092-1129>



Color: ■ light gray

Similar to illustration

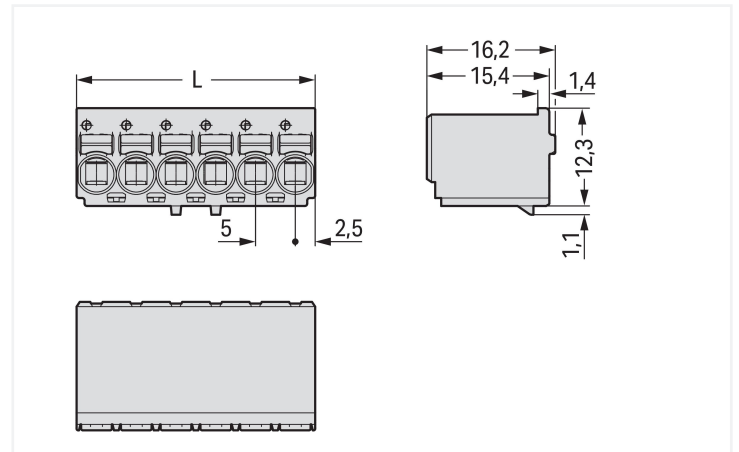

Dimensions in mm

L = pole no. x pin spacing

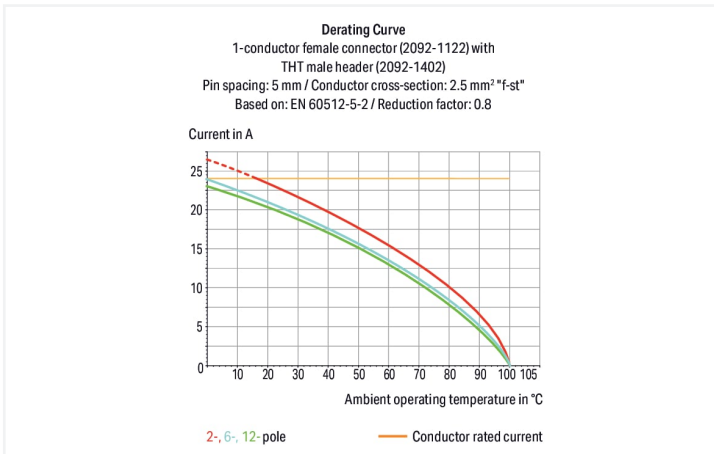

- Universal connection of all conductor types
- Simple, push-in termination of solid and ferruled conductors
- Easy-to-use design does not require special tools
- Ability to wire while mated or unmated
- Testing parallel to conductor entry – tip contact
- Also available with gripping plates
- Integrated locking latches prevent accidental disconnection

Notes

Safety Information

The **picoMAX® Pluggable Connection System** includes connectors without breaking capacity in accordance with DIN EN 61984. When used as intended, these connectors must not be connected/disconnected when live or under load. The circuit design should ensure header pins, which can be touched, are not live when unmated.

Safety information 2

The use of ferrules is recommended for applications with higher requirements.

Variants:

Effective cable securing must be used to prevent undue force on the clamping unit.

Direct marking

Other versions (or variants) can be requested from WAGO Sales or configured at <https://configurator.wago.com/>.

Electrical data

Ratings per	IEC/EN 60664-1			Approvals per	UL 1059		
Overvoltage category	III	III	II	Use group	B	C	D
Pollution degree	3	2	2	Rated voltage	300 V	-	300 V
Nominal voltage	250 V	320 V	630 V	Rated current	15 A	-	10 A
Rated surge voltage	4 kV	4 kV	4 kV				
Rated current	16 A	16 A	16 A				

Connection data

Clamping units	9	Connection 1	
Total number of potentials	9	Connection technology	Push-in CAGE CLAMP®
Number of connection types	1	Actuation type	Push-button
Number of levels	1	Actuation direction 1	Operation parallel to conductor entry
		Solid conductor	0.2 ... 2.5 mm ² / 24 ... 12 AWG
		Fine-stranded conductor	0.2 ... 2.5 mm ² / 24 ... 12 AWG
		Fine-stranded conductor; with insulated ferrule	0.25 ... 1.5 mm ²
		Fine-stranded conductor; with uninsulated ferrule	0.25 ... 2.5 mm ²
		Strip length	9 ... 10 mm / 0.35 ... 0.39 inches
		Pole number	9

Physical data

Pin spacing	5 mm / 0.197 inches
Width	45 mm / 1.772 inches
Height	16.2 mm / 0.638 inches
Depth	13.4 mm / 0.528 inches

Mechanical data

Variable coding	Yes
Anti-rotation protection	Yes

Plug-in connection

Contact type (pluggable connector)	Female connector/socket
Connector (connection type)	for conductor
Mismating protection	No
Plugging without loss of pin spacing	Yes

Material data

Note (material data)	Information on material specifications can be found here
Color	light gray
Material group	I
Insulation material (main housing)	Polyphthalamide (PPA GF)
Flammability class per UL94	V0
Clamping spring material	Chrome-nickel spring steel (CrNi)
Contact material	Electrolytic copper (E _{Cu})
Contact Plating	Tin
Fire load	0.023 MJ
Weight	8.4 g

Environmental requirements

Limit temperature range	-60 ... +100 °C
Processing temperature	-35 ... +60 °C

Commercial data

Product Group	26 (picoMAX Connectors)
eCl@ss 10.0	27-14-11-06
eCl@ss 9.0	27-14-11-06
ETIM 9.0	EC001284
ETIM 8.0	EC001284
PU (SPU)	100 pcs
Packaging type	Box
Country of origin	DE
GTIN	4050821821632
Customs tariff number	85366990990

Environmental Product Compliance

RoHS Compliance Status	Compliant, No Exemption
------------------------	-------------------------

Approvals / Certificates

General approvals



Approval	Standard	Certificate Name
CB DEKRA Certification B.V.	IEC 61984	NL-49737/A1
CSA DEKRA Certification B.V.	C22.2	2362521
CSA DEKRA Certification B.V.	C22.2 No. 158	2362521
cURus Underwriters Laboratories Inc.	UL 1059	E45172
KEMA/KEUR DEKRA Certification B.V.	EN 61984	71-102261 REV.2
UL Underwriters Laboratories Inc.	UL 1977	E45171

Downloads

Environmental Product Compliance

Compliance Search

Environmental Product
Compliance 2092-1129



Documentation

Additional Information			
Technical Section	03.04.2019	pdf 2027.26 KB	↓

CAD/CAE-Data

CAD data	CAE data
2D/3D Models 2092-1129 ↓	ZUKEN Portal 2092-1129 ↓

1 Compatible Products

1.1 System counterpart

1.1.1 Male connector/plug



Item No.: 2092-1729/200-000
THR pin strip; 1.4 mm Ø solder pin; angled;
Pin spacing 5 mm; 9-pole; black

Item No.: 2092-1709/200-000
THR pin strip; 1.4 mm Ø solder pin;
straight; Pin spacing 5 mm; 9-pole; black

Item No.: 2092-1429
THT male header; 1.4 mm Ø solder pin;
angled; Pin spacing 5 mm; 9-pole; light
gray

Item No.: 2092-1409
THT male header; 1.4 mm Ø solder pin;
straight; Pin spacing 5 mm; 9-pole; light
gray



Item No.: 2092-1729
THT pin strip; 1.4 mm Ø solder pin; angled;
Pin spacing 5 mm; 9-pole; black

Item No.: 2092-1709
THT pin strip; 1.4 mm Ø solder pin;
straight; Pin spacing 5 mm; 9-pole; black

1.2 Optional Accessories

1.2.1 Ferrule

1.2.1.1 Ferrule



Item No.: 216-301
Ferrule; Sleeve for 0.25 mm² / AWG 24; un-
insulated; electro-tin plated; yellow

Item No.: 216-131
Ferrule; Sleeve for 0.25 mm² / AWG 24;
uninsulated; electro-tin plated; silver-co-
lored

Item No.: 216-302
Ferrule; Sleeve for 0.34 mm² / 22 AWG; in-
sulated; electro-tin plated; light turquoise

Item No.: 216-132
Ferrule; Sleeve for 0.34 mm² / AWG 24;
uninsulated; electro-tin plated



Item No.: 216-101
Ferrule; Sleeve for 0.5 mm² / AWG 22; un-
insulated; electro-tin plated; silver-co-
red

Item No.: 216-202
Ferrule; Sleeve for 0.75 mm² / 18 AWG; un-
insulated; electro-tin plated; gray

Item No.: 216-102
Ferrule; Sleeve for 0.75 mm² / AWG 20;
uninsulated; electro-tin plated; silver-co-
lored

Item No.: 216-122
Ferrule; Sleeve for 0.75 mm² / AWG 20;
uninsulated; electro-tin plated; silver-co-
lored



Item No.: 216-203
Ferrule; Sleeve for 1 mm² / AWG 18; insu-
lated; electro-tin plated; red

Item No.: 216-103
Ferrule; Sleeve for 1 mm² / AWG 18; unin-
sulated; electro-tin plated

Item No.: 216-143
Ferrule; Sleeve for 1 mm² / AWG 18; unin-
sulated; electro-tin plated; electrolytic
copper; gastight crimped; acc. to DIN
46228, Part 1/08.92

Item No.: 216-204
Ferrule; Sleeve for 1.5 mm² / AWG 16; in-
sulated; electro-tin plated; black



Item No.: 216-144
Ferrule; Sleeve for 1.5 mm² / AWG 16; un-
insulated; electro-tin plated; electrolytic
copper; gastight crimped; acc. to DIN
46228, Part 1/08.92; silver-colored

Item No.: 216-104
Ferrule; Sleeve for 1.5 mm² / AWG 16; un-
insulated; electro-tin plated; silver-co-
red

Item No.: 216-106
Ferrule; Sleeve for 2.5 mm² / AWG 14; un-
insulated; electro-tin plated; silver-co-
red

1.2.2 Strain relief

1.2.2.1 Gripping plate



Item No.: 2092-1603/002-000

Gripping plate with sliding connector release; for female and male connectors; 2 parts; Pin spacing 5 mm; light gray

Item No.: 2092-1603

Gripping plate; for female and male connectors; 1 part; Pin spacing 5 mm; light gray

1.2.3 Test and measurement

1.2.3.1 Testing accessories



Item No.: 735-500

WAGO Test pin; 1 mm Ø; 30 V AC / 60 V DC; CAT0; 1 A; 6 mm uninsulated; Test lead for soldering up to 0,5mm²

1.2.4 Tool

1.2.4.1 Operating tool



Item No.: 210-719

Operating tool; Blade: 2.5 x 0.4 mm; with a partially insulated shaft

Item No.: 2092-1630

Unlocking tool; orange

Installation Notes

Locking system

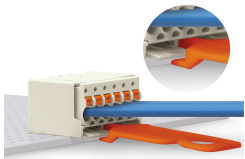

Disconnecting a female connector via unlocking tool. Plug unlocking tool into the male header's locking latch.

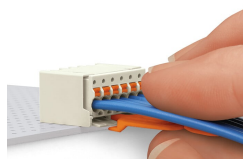

Insert unlocking tool until it hits the backstop. Wedge opens locking latches.

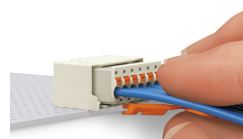

Pull on both unlocking tool and conductors to remove female connector from male header.

Conductor termination

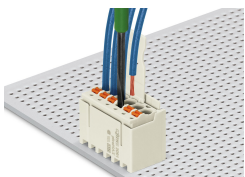

Inserting fine-stranded conductor into mated female connector via push-button.



Inserting a fine-stranded conductor into an unmated female connector via push-button.

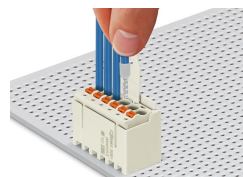

Inserting solid and ferruled conductors via push-in termination.

Marking



Pole marking via factory direct marking.

Coding



Coding a female connector (via coding key carrier and two keys for female connector, see symbol).

Testing



Testing via 1 mm Ø test pin – touch contact.