

Data Sheet | Item Number: 289-585

Interface module; with solder pin; Male connector; 9-pole; Mating connector with solder connection; Vertical mounting; PCB terminal blocks, double-row; in mounting carrier; with shield connection; 2,50 mm²

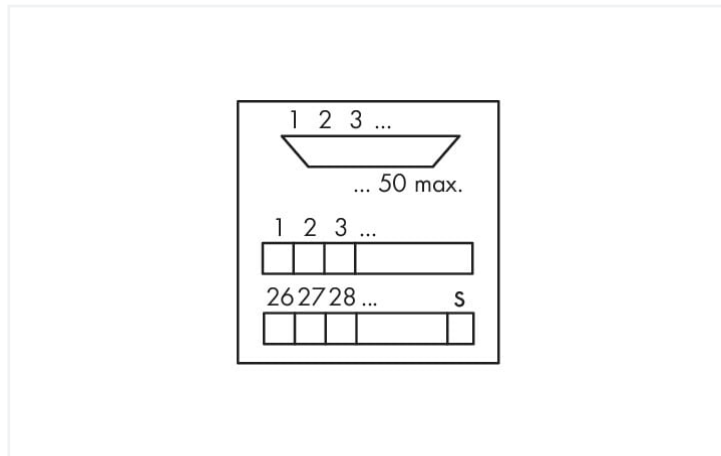

<https://www.wago.com/289-585>



Electrical data

Operating voltage	≤ AC/DC 125 V
Nominal current	2 A
Contact resistance (max.)	30 mΩ
Specialty functions	With shield connection

Safety and protection

Rated voltage	125 V
Rated surge voltage	0.8 kV
Pollution degree	2
Protection type	IP20
Insulation type	Basic insulation

Connection data

Performance level	2 / 200 mating cycles
Strain relief	UNC 4-40 stud bolt

Connection 1

Connector	D-subminiature male connector
Pole number 1	9
Connection type 1	System
Note (conductor cross-section)	12 AWG: THHN, THWN
Mating direction	vertical

Connection 2

Design 2	PCB terminal blocks (double-row)
Pole number 2	10
Connection type 2	Field
Connection technology 2	CAGE CLAMP®
WAGO connector 2	WAGO 236 Series
Solid conductor 2	0.08 ... 2.5 mm ² / 28 ... 12 AWG
Fine-stranded conductor 2	0.08 ... 2.5 mm ² / 28 ... 12 AWG
Strip length 2	5 ... 6 mm / 0.2 ... 0.24 inches

Physical data

Width	38.5 mm / 1.516 inches
Height	85 mm / 3.346 inches
Depth from upper-edge of DIN-rail	34 mm / 1.339 inches

Mechanical data

Mounting type	DIN-35 rail
Housing design	Mounting carrier

Material data

Contact material (connector)	Au over Ni
Fire load	0.91 MJ
Weight	47.5 g

Environmental requirements

Ambient temperature (operation)	-20 ... +50 °C
Ambient temperature (storage)	-40 ... +70 °C
Relative humidity	≤ 85% (non-condensing)

Standards and specifications

Standards/specifications	EN 61010-2-201
--------------------------	----------------

Commercial data

Product Group	6 (INTERFACE ELECTRONIC)
eCl@ss 10.0	27-14-11-52
eCl@ss 9.0	27-14-11-52
ETIM 8.0	EC002780
ETIM 7.0	EC002780
PU (SPU)	8 (1) pcs
Packaging type	Box
Country of origin	DE
GTIN	4045454367152
Customs tariff number	85366990990

Environmental Product Compliance

RoHS Compliance Status	Compliant, No Exemption
------------------------	-------------------------

Approvals / Certificates

General approvals



Approval	Standard	Certificate Name
EAC Brjansker Zertifizierungs- stelle	TP TC 004/2011	EAC RU C-DE.AM02. B.00122/19
UL Underwriters Laboratories Inc. (ORDINARY LOCATI- ONS)	UL 508	E175199 Vol.2 Sec.1

Downloads

Environmental Product Compliance

Compliance Search			
Environmental Product Compliance 289-585			↓

Documentation

Bid Text			
289-585	19.02.2019	xml 3.59 KB	↓
289-585	06.02.2015	doc 27.00 KB	↓

Instruction Leaflet	
	pdf 1246.19 KB ↓

CAD/CAE-Data

CAD data	
2D/3D Models 289-585	↓

CAE data	
EPLAN Data Portal 289-585	↓
WSCAD Universe 289-585	↓
ZUKEN Portal 289-585	↓

1 Compatible Products

1.1 Optional Accessories

1.1.1 Marking

1.1.1.1 Marking strip



Item No.: 709-196
Marking strips; for laser printer; translucent



Item No.: 709-177
Marking strips; on reel; 7.5 mm wide; not stretchable; plain; snap-on type; translucent



Item No.: 709-178
Marking strips; on reel; 7.5 mm wide; not stretchable; plain; snap-on type; white

1.1.2 Tool

1.1.2.1 Operating tool



Item No.: 210-720

Operating tool; Blade: 3.5 x 0.5 mm; with a partially insulated shaft; multicoloured

Installation Notes

Conductor termination

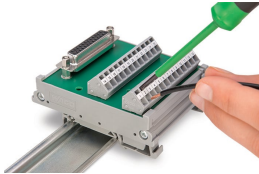

Conductor termination – screwdriver actuation parallel to conductor entry

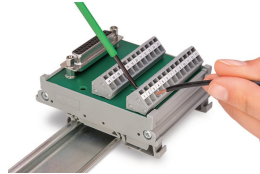

Conductor termination – screwdriver actuation perpendicular to conductor entry

Installation

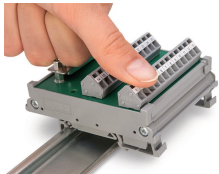

Snapping a module onto DIN-rail.

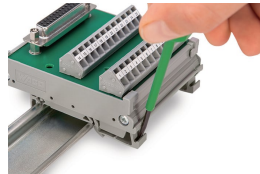

Removing a module from the DIN-rail.