

Data Sheet | Item Number: 2002-1661

2-conductor carrier terminal block; for DIN-rail 35 x 15 and 35 x 7.5; 2.5 mm²; Push-in CAGE CLAMP®; 2,50 mm²; gray

<https://www.wago.com/2002-1661>

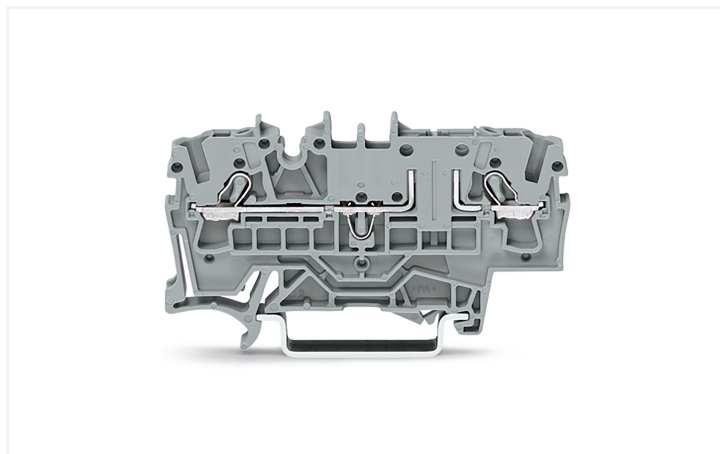
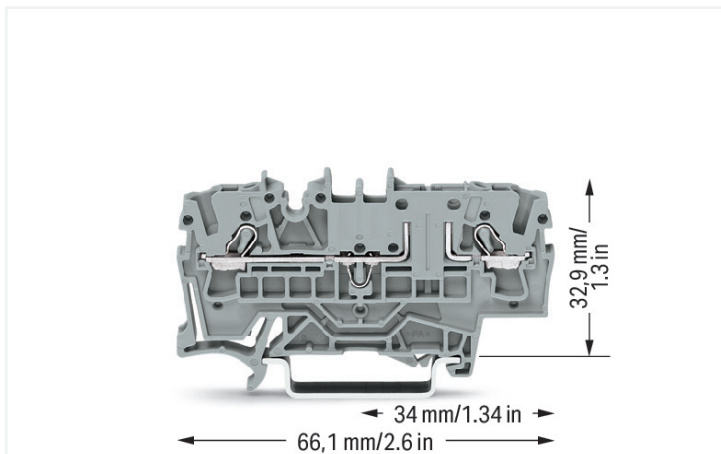

Color: ■ gray

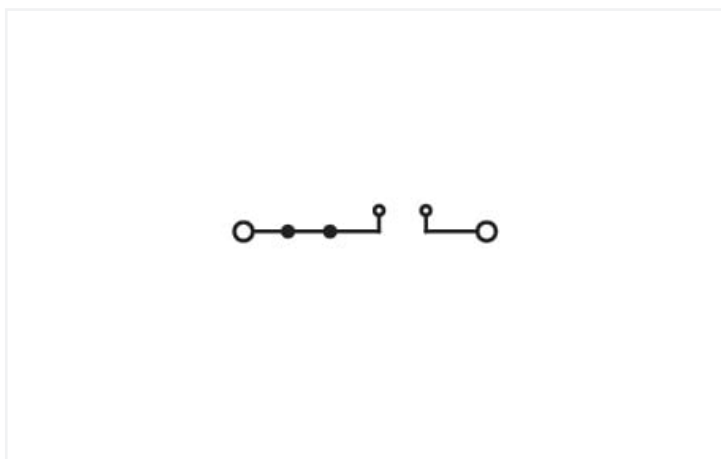

Similar to illustration

Electrical data

Ratings per	IEC/EN 60947-7-1		
Overvoltage category	III	III	II
Pollution degree	3	2	2
Nominal voltage	400 V	-	-
Rated surge voltage	6 kV	-	-
Rated current	16 A	-	-

Approvals per	UL 1059		
Use group	B	C	D
Rated voltage	300 V	300 V	-
Rated current	15 A	15 A	-

Approvals per	CSA 22.2 No 158		
Use group	B	C	D
Rated voltage	300 V	300 V	-
Rated current	15 A	15 A	-

Ex information	
Reference hazardous areas	See "Downloads – Documentation – Additional Information: Technical Section; Technical Explanations"
Ratings per	ATEX: KIWA 17 ATEX 0030 U / IECEx: KI-WA 17.0014U (Ex ec IIC Gc)
Rated voltage EN (Ex e II)	440 V
Rated current (Ex e II)	17 A

Power Loss

Power loss, per pole (potential)	0.3405 W
Rated current I_N for specified power loss	16 A
Resistance value for specified, current-dependent power loss	0.00133 Ω

Connection data

Connection points	2
Total number of potentials	2
Number of levels	1
Number of jumper slots	2

Connection 1

Connection technology	Push-in CAGE CLAMP®
Actuation type	Operating tool
Connectable conductor materials	Copper
Nominal cross-section	2.5 mm ²
Solid conductor	0.25 ... 4 mm ² / 22 ... 12 AWG
Solid conductor; push-in termination	0.75 ... 4 mm ² / 18 ... 12 AWG
Fine-stranded conductor	0.25 ... 4 mm ² / 22 ... 12 AWG
Fine-stranded conductor; with insulated ferrule	0.25 ... 2.5 mm ² / 22 ... 14 AWG
Fine-stranded conductor; with ferrule; push-in termination	1 ... 2.5 mm ² / 18 ... 14 AWG
Note (conductor cross-section)	Depending on the conductor characteristic, a conductor with a smaller cross-section can also be inserted via push-in termination.
Strip length	10 ... 12 mm / 0.39 ... 0.47 inches
Wiring direction	Front-entry wiring

Physical data

Width	5.2 mm / 0.205 inches
Height	66.1 mm / 2.602 inches
Depth from upper-edge of DIN-rail	32.9 mm / 1.295 inches

Mechanical data

Mounting type	DIN-35 rail
Marking level	Center/side marking

Material data

Note (material data)	Information on material specifications can be found here
Color	gray
Material group	I
Insulation material	Polyamide (PA66)
Flammability class per UL94	V0
Fire load	0.151 MJ
Weight	7 g

Environmental requirements

Processing temperature	-35 ... +85 °C
Continuous operating temperature	-60 ... +105 °C

Commercial data

Product Group	22 (TOPJOB S)
eCl@ss 10.0	27-14-11-20
eCl@ss 9.0	27-14-11-20
ETIM 8.0	EC000897
ETIM 7.0	EC000897
PU (SPU)	50 pcs
Packaging type	Box
Country of origin	CN
GTIN	4055143897143
Customs tariff number	85369010000

Environmental Product Compliance

RoHS Compliance Status	Compliant, No Exemption
------------------------	-------------------------

Approvals / Certificates

General approvals



Approval	Standard	Certificate Name
CCA DEKRA Certification B.V.	EN 60947	NTR NL 7941
CSA DEKRA Certification B.V.	C22.2 No. 158	1536069
KEMA/KEUR DEKRA Certification B.V.	EN 60947	71-124163
UL Underwriters Laboratories Inc.	UL 1059	E45172

Declarations of conformity and manufacturer's declarations



Approval	Standard	Certificate Name
ATEX-Attestation of Conformity WAGO GmbH & Co. KG	-	-
ATEX-Attestation of Conformity WAGO GmbH & Co. KG	-	-
EU-Declaration of Conformity WAGO GmbH & Co. KG	-	-
Railway WAGO GmbH & Co. KG	-	Railway Ready
UK-Declaration of Conformity WAGO GmbH & Co. KG	-	-

Approvals for marine applications



Approval	Standard	Certificate Name
ABS American Bureau of Shipping	EN 60947	20-HG1941090-PDA
DNV GL Det Norske Veritas, Germanischer Lloyd	-	TAE00001V2

Approvals for hazardous areas



Approval	Standard	Certificate Name
AEx Underwriters Laboratories Inc.	UL 60079	E185892 (AEx eb IIC resp. Ex eb IIC)
ATEX KIWA Netherlands B.V.	EN 60079	KIWA 17ATEX0030 U
CCC CNEX	GB/T 3836.3	2020312313000180 (Ex ec IIC Gc)
IECEx KIWA Netherlands B.V.	EN 60079	IECEx KIWA 17.0014U (Ex ec IIC Gc)

Downloads

Environmental Product Compliance

Compliance Search	
Environmental Product Compliance 2002-1661	↓

Documentation

Bid Text			
2002-1661	29.04.2019	xml 3.88 KB	↓
2002-1661	23.04.2019	docx 15.50 KB	↓

CAD/CAE-Data

CAD data	
2D/3D Models 2002-1661	↓

CAE data	
EPLAN Data Portal 2002-1661	↓
WSCAD Universe 2002-1661	↓
ZUKEN Portal 2002-1661	↓

1 Compatible Products

1.1 Required Accessories

1.1.1 End plate

1.1.1.1 End plate



Item No.: 2002-1691
End and intermediate plate; 1 mm thick; gray

Item No.: 2002-1692
End and intermediate plate; 1 mm thick; orange

1.2 Optional Accessories

1.2.1 DIN-rail

1.2.1.1 Mounting accessories



Item No.: 210-196
Aluminum carrier rail; 35 x 8.2 mm; 1.6 mm thick; 2 m long; unslotted; similar to EN 60715; silver-colored



Item No.: 210-198
Copper carrier rail; 35 x 15 mm; 2.3 mm thick; 2 m long; unslotted; according to EN 60715; copper-colored



Item No.: 210-508
Steel carrier rail; 35 x 15 mm; 1.5 mm thick; 2 m long; slotted; galvanized; similar to EN 60715; silver-colored



Item No.: 210-197
Steel carrier rail; 35 x 15 mm; 1.5 mm thick; 2 m long; slotted; similar to EN 60715; silver-colored



Item No.: 210-506
Steel carrier rail; 35 x 15 mm; 1.5 mm thick; 2 m long; unslotted; galvanized; similar to EN 60715; silver-colored



Item No.: 210-114
Steel carrier rail; 35 x 15 mm; 1.5 mm thick; 2 m long; unslotted; similar to EN 60715; silver-colored



Item No.: 210-118
Steel carrier rail; 35 x 15 mm; 2.3 mm thick; 2 m long; unslotted; according to EN 60715; silver-colored



Item No.: 210-115
Steel carrier rail; 35 x 7.5 mm; 1 mm thick; 2 m long; slotted; according to EN 60715; "Hole width 18 mm; silver-colored

1.2.1.1 Mounting accessories



Item No.: 210-112

Steel carrier rail; 35 x 7.5 mm; 1 mm thick; 2 m long; slotted; according to EN 60715; "Hole width 25 mm; silver-colored



Item No.: 210-504

Steel carrier rail; 35 x 7.5 mm; 1 mm thick; 2 m long; slotted; galvanized; according to EN 60715; silver-colored



Item No.: 210-113

Steel carrier rail; 35 x 7.5 mm; 1 mm thick; 2 m long; unslotted; according to EN 60715; silver-colored



Item No.: 210-505

Steel carrier rail; 35 x 7.5 mm; 1 mm thick; 2 m long; unslotted; galvanized; according to EN 60715; silver-colored

1.2.2 Ferrule

1.2.2.1 Ferrule



Item No.: 216-241

Ferrule; Sleeve for 0.5 mm² / 20 AWG; insulated; electro-tin plated; electrolytic copper; gastight crimped; acc. to DIN 46228, Part 4/09.90; white



Item No.: 216-242

Ferrule; Sleeve for 0.75 mm² / 18 AWG; insulated; electro-tin plated; electrolytic copper; gastight crimped; acc. to DIN 46228, Part 4/09.90; gray



Item No.: 216-262

Ferrule; Sleeve for 0.75 mm² / 18 AWG; insulated; electro-tin plated; electrolytic copper; gastight crimped; acc. to DIN 46228, Part 4/09.90; gray



Item No.: 216-243

Ferrule; Sleeve for 1 mm² / AWG 18; insulated; electro-tin plated; electrolytic copper; gastight crimped; acc. to DIN 46228, Part 4/09.90; red



Item No.: 216-263

Ferrule; Sleeve for 1 mm² / AWG 18; insulated; electro-tin plated; electrolytic copper; gastight crimped; acc. to DIN 46228, Part 4/09.90; red



Item No.: 216-244

Ferrule; Sleeve for 1.5 mm² / AWG 16; insulated; electro-tin plated; electrolytic copper; gastight crimped; acc. to DIN 46228, Part 4/09.90; black



Item No.: 216-264

Ferrule; Sleeve for 1.5 mm² / AWG 16; insulated; electro-tin plated; electrolytic copper; gastight crimped; acc. to DIN 46228, Part 4/09.90; black



Item No.: 216-246

Ferrule; Sleeve for 2.5 mm² / AWG 14; insulated; electro-tin plated; electrolytic copper; gastight crimped; acc. to DIN 46228, Part 4/09.90; blue



Item No.: 216-266

Ferrule; Sleeve for 2.5 mm² / AWG 14; insulated; electro-tin plated; electrolytic copper; gastight crimped; acc. to DIN 46228, Part 4/09.90; blue

1.2.3 Installation

1.2.3.1 Cover



Item No.: 709-156

Cover; Type 3; suitable for cover carrier, type 3; 1 m long; transparent

1.2.3.2 Cover carrier



Item No.: 709-169

Cover carrier; Type 3; incl. fixing/retaining screws and knurled nut; suitable for 279 to 282 and 880 Series rail-mounted terminal blocks; suitable for 264 Series miniature rail-mounted terminal blocks; suitable for 270 Series sensor and actuator terminal blocks; gray

1.2.4 Insulation stop

1.2.4.1 Insulation stop



Item No.: 2002-171

Insulation stop; 0.25 - 0.5 mm²; 5 pieces/strip; light gray

Item No.: 2002-172

Insulation stop; 0.75 - 1 mm²; 5 pieces/strip; dark gray

1.2.5 Jumper

1.2.5.1 Jumper



Item No.: 2002-400

Continuous jumper; 2-way; insulated; light gray



Item No.: 2002-423/000-006

Continuous jumper; from 1 to 3; insulated; blue



Item No.: 2002-423

Continuous jumper; from 1 to 3; insulated; light gray



Item No.: 2002-423/000-005

Continuous jumper; from 1 to 3; insulated; red



Item No.: 2002-424/000-006

Continuous jumper; from 1 to 4; insulated; blue



Item No.: 2002-424

Continuous jumper; from 1 to 4; insulated; light gray



Item No.: 2002-424/000-005

Continuous jumper; from 1 to 4; insulated; red



Item No.: 2002-406/020-000

Delta jumper; insulated; light gray



Item No.: 2002-410/000-006

Jumper; 10-way; insulated; blue



Item No.: 2002-410

Jumper; 10-way; insulated; light gray



Item No.: 2002-410/000-005

Jumper; 10-way; insulated; red



Item No.: 2002-402/000-006

Jumper; 2-way; insulated; blue



Item No.: 2002-402

Jumper; 2-way; insulated; light gray



Item No.: 2002-402/000-005

Jumper; 2-way; insulated; red



Item No.: 2002-403/000-006

Jumper; 3-way; insulated; blue



Item No.: 2002-403

Jumper; 3-way; insulated; light gray



Item No.: 2002-403/000-005

Jumper; 3-way; insulated; red



Item No.: 2002-404/000-006

Jumper; 4-way; insulated; blue



Item No.: 2002-404

Jumper; 4-way; insulated; light gray



Item No.: 2002-404/000-005

Jumper; 4-way; insulated; red



Item No.: 2002-405/000-006

Jumper; 5-way; insulated; blue



Item No.: 2002-405

Jumper; 5-way; insulated; light gray



Item No.: 2002-405/000-005

Jumper; 5-way; insulated; red



Item No.: 2002-406/000-006

Jumper; 6-way; insulated; blue



Item No.: 2002-406

Jumper; 6-way; insulated; light gray



Item No.: 2002-406/000-005

Jumper; 6-way; insulated; red



Item No.: 2002-407/000-006

Jumper; 7-way; insulated; blue



Item No.: 2002-407

Jumper; 7-way; insulated; light gray



Item No.: 2002-407/000-005

Jumper; 7-way; insulated; red



Item No.: 2002-408/000-006

Jumper; 8-way; insulated; blue



Item No.: 2002-408

Jumper; 8-way; insulated; light gray



Item No.: 2002-408/000-005

Jumper; 8-way; insulated; red



Item No.: 2002-409/000-006

Jumper; 9-way; insulated; blue



Item No.: 2002-409

Jumper; 9-way; insulated; light gray



Item No.: 2002-409/000-005

Jumper; 9-way; insulated; red



Item No.: 2002-440

Jumper; from 1 to 10; insulated; light gray



Item No.: 2002-433

Jumper; from 1 to 3; insulated; light gray



Item No.: 2002-434

Jumper; from 1 to 4; insulated; light gray



Item No.: 2002-435

Jumper; from 1 to 5; insulated; light gray



Item No.: 2002-436

Jumper; from 1 to 6; insulated; light gray



Item No.: 2002-437

Jumper; from 1 to 7; insulated; light gray



Item No.: 2002-438

Jumper; from 1 to 8; insulated; light gray



Item No.: 2002-439

Jumper; from 1 to 9; insulated; light gray



Item No.: 2002-480

























Staggered jumper; 10-way; insulated; light gray

1.2.5.1 Jumper

 Item No.: 2002-481 Staggered jumper; 11-way; insulated; light gray	 Item No.: 2002-482 Staggered jumper; 12-way; insulated; light gray	 Item No.: 2002-473/011-000 Staggered jumper; 2-way; from 1 to 3; insulated; light gray	 Item No.: 2002-472 Staggered jumper; 2-way; insulated; light gray
 Item No.: 2002-473 Staggered jumper; 3-way; insulated; light gray	 Item No.: 2002-475/011-000 Staggered jumper; 3-way; insulated; light gray	 Item No.: 2002-474 Staggered jumper; 4-way; insulated; light gray	 Item No.: 2002-475 Staggered jumper; 5-way; insulated; light gray
 Item No.: 2002-476 Staggered jumper; 6-way; insulated; light gray	 Item No.: 2002-477 Staggered jumper; 7-way; insulated; light gray	 Item No.: 2002-478 Staggered jumper; 8-way; insulated; light gray	 Item No.: 2002-479 Staggered jumper; 9-way; insulated; light gray
 Item No.: 2002-477/011-000 Staggered jumper; insulated; light gray	 Item No.: 2002-479/011-000 Staggered jumper; insulated; light gray	 Item No.: 2002-481/011-000 Staggered jumper; insulated; light gray	 Item No.: 2002-405/011-000 Star point jumper; 3-way; insulated; light gray
 Item No.: 210-103 Wire commoning chain; insulated; black	 Item No.: 210-123 Wire commoning chain; insulated; blue		

1.2.6 Marking

1.2.6.1 Marker

 Item No.: 2009-145/000-006 Mini-WSB In-line; for Smart Printer; 1700 pieces on roll; stretchable 5 - 5.2 mm; plain; snap-on type; blue	 Item No.: 2009-145/000-007 Mini-WSB In-line; for Smart Printer; 1700 pieces on roll; stretchable 5 - 5.2 mm; plain; snap-on type; gray	 Item No.: 2009-145/000-023 Mini-WSB In-line; for Smart Printer; 1700 pieces on roll; stretchable 5 - 5.2 mm; plain; snap-on type; green	 Item No.: 2009-145/000-012 Mini-WSB In-line; for Smart Printer; 1700 pieces on roll; stretchable 5 - 5.2 mm; plain; snap-on type; orange
 Item No.: 2009-145/000-005 Mini-WSB In-line; for Smart Printer; 1700 pieces on roll; stretchable 5 - 5.2 mm; plain; snap-on type; red	 Item No.: 2009-145/000-024 Mini-WSB In-line; for Smart Printer; 1700 pieces on roll; stretchable 5 - 5.2 mm; plain; snap-on type; violet	 Item No.: 2009-145 Mini-WSB In-line; for Smart Printer; 1700 pieces on roll; stretchable 5 - 5.2 mm; plain; snap-on type; white	 Item No.: 2009-145/000-002 Mini-WSB In-line; for Smart Printer; 1700 pieces on roll; stretchable 5 - 5.2 mm; plain; snap-on type; yellow
 Item No.: 248-501/000-006 Mini-WSB marking card; as card; not stretchable; plain; snap-on type; blue	 Item No.: 248-501/000-007 Mini-WSB marking card; as card; not stretchable; plain; snap-on type; gray	 Item No.: 248-501/000-023 Mini-WSB marking card; as card; not stretchable; plain; snap-on type; green	 Item No.: 248-501/000-017 Mini-WSB marking card; as card; not stretchable; plain; snap-on type; light green
 Item No.: 248-501/000-012 Mini-WSB marking card; as card; not stretchable; plain; snap-on type; orange	 Item No.: 248-501/000-005 Mini-WSB marking card; as card; not stretchable; plain; snap-on type; red	 Item No.: 248-501/000-024 Mini-WSB marking card; as card; not stretchable; plain; snap-on type; violet	 Item No.: 248-501 Mini-WSB marking card; as card; not stretchable; plain; snap-on type; white
 Item No.: 248-501/000-002 Mini-WSB marking card; as card; not stretchable; plain; snap-on type; yellow	 Item No.: 793-5501/000-006 WMB marking card; as card; for terminal block width 5 - 17.5 mm; stretchable 5 - 5.2 mm; plain; snap-on type; blue	 Item No.: 793-5501/000-014 WMB marking card; as card; for terminal block width 5 - 17.5 mm; stretchable 5 - 5.2 mm; plain; snap-on type; brown	 Item No.: 793-5501/000-007 WMB marking card; as card; for terminal block width 5 - 17.5 mm; stretchable 5 - 5.2 mm; plain; snap-on type; gray
 Item No.: 793-5501/000-023 WMB marking card; as card; for terminal block width 5 - 17.5 mm; stretchable 5 - 5.2 mm; plain; snap-on type; green	 Item No.: 793-5501/000-017 WMB marking card; as card; for terminal block width 5 - 17.5 mm; stretchable 5 - 5.2 mm; plain; snap-on type; light green	 Item No.: 793-5501/000-012 WMB marking card; as card; for terminal block width 5 - 17.5 mm; stretchable 5 - 5.2 mm; plain; snap-on type; orange	 Item No.: 793-5501/000-005 WMB marking card; as card; for terminal block width 5 - 17.5 mm; stretchable 5 - 5.2 mm; plain; snap-on type; red

1.2.6.1 Marker



Item No.: 793-5501/000-024

WMB marking card; as card; for terminal block width 5 - 17.5 mm; stretchable 5 - 5.2 mm; plain; snap-on type; violet

Item No.: 793-5501

WMB marking card; as card; for terminal block width 5 - 17.5 mm; stretchable 5 - 5.2 mm; plain; snap-on type; white

Item No.: 793-5501/000-002

WMB marking card; as card; for terminal block width 5 - 17.5 mm; stretchable 5 - 5.2 mm; plain; snap-on type; yellow

Item No.: 2009-115/000-006

WMB-Inline; for Smart Printer; 1500 pieces on roll; stretchable 5 - 5.2 mm; plain; snap-on type; blue



Item No.: 2009-115/000-007

WMB-Inline; for Smart Printer; 1500 pieces on roll; stretchable 5 - 5.2 mm; plain; snap-on type; gray

Item No.: 2009-115/000-023

WMB-Inline; for Smart Printer; 1500 pieces on roll; stretchable 5 - 5.2 mm; plain; snap-on type; green

Item No.: 2009-115/000-017

WMB-Inline; for Smart Printer; 1500 pieces on roll; stretchable 5 - 5.2 mm; plain; snap-on type; light green

Item No.: 2009-115/000-012

WMB-Inline; for Smart Printer; 1500 pieces on roll; stretchable 5 - 5.2 mm; plain; snap-on type; orange



Item No.: 2009-115/000-005

WMB-Inline; for Smart Printer; 1500 pieces on roll; stretchable 5 - 5.2 mm; plain; snap-on type; red

Item No.: 2009-115/000-024

WMB-Inline; for Smart Printer; 1500 pieces on roll; stretchable 5 - 5.2 mm; plain; snap-on type; violet

Item No.: 2009-115

WMB-Inline; for Smart Printer; 1500 pieces on roll; stretchable 5 - 5.2 mm; plain; snap-on type; white

Item No.: 2009-115/000-002

WMB-Inline; for Smart Printer; 1500 pieces on roll; stretchable 5 - 5.2 mm; plain; snap-on type; yellow

1.2.6.2 Marking strip



Item No.: 2009-110

Marking strips; for Smart Printer; on reel; not stretchable; plain; snap-on type; white

1.2.7 Plug

1.2.7.1 Component module with diode



Item No.: 2002-800/1000-411

Component plug; for carrier terminal blocks; 2-pole; with diode 1N4007; 5.2 mm wide; Operating temperature 85°C max.; gray

Item No.: 2002-800/1000-410

Component plug; for carrier terminal blocks; 2-pole; with diode 1N4007; anode, left side; 5.2 mm wide; Operating temperature 85°C max.; gray

1.2.7.2 Component module with LED



Item No.: 2002-800/1000-541

Component plug; for carrier terminal blocks; 1-pole; LED (red); 5.2 mm wide; Operating temperature 85°C max.; gray

Item No.: 2002-800/1000-542

Component plug; for carrier terminal blocks; 1-pole; LED (red); 5.2 mm wide; Operating temperature 85°C max.; gray

Item No.: 2002-800/1000-836

Component plug; for carrier terminal blocks; 1-pole; LED (red); 5.2 mm wide; Operating temperature 85°C max.; gray

1.2.7.3 Disconnect plug



Item No.: 2002-401

Disconnect plug for carrier terminal blocks; for using a receptacle terminal block as a disconnect terminal block; orange

1.2.7.4 Empty component plug housing



Item No.: 2002-810
Empty component plug housing; 10.4 mm wide; 2-pole; Type 2; gray



Item No.: 2002-820
Empty component plug housing; 10.4 mm wide; 4-pole; Type 3; gray



Item No.: 2002-800
Empty component plug housing; 5.2 mm wide; 2-pole; Type 1; gray

1.2.7.5 Fuse plug



Item No.: 2003-911/1000-923
Double fuse plug; for 5 x 20 mm miniature metric fuse; with indicator lamp; 230 V; 10.4 mm wide; gray



Item No.: 2003-911
Double fuse plug; for 5 x 20 mm miniature metric fuse; without blown fuse indication; 10.4 mm wide; gray



Item No.: 2004-911/1000-541
Fuse plug; with pull-tab; for 5 x 20 mm miniature metric fuse; with indicator lamp; 12 - 30 V; 6.1 mm wide; gray



Item No.: 2004-911/1000-867
Fuse plug; with pull-tab; for 5 x 20 mm miniature metric fuse; with indicator lamp; 120 V; 6.1 mm wide; gray



Item No.: 2004-911/1000-836
Fuse plug; with pull-tab; for 5 x 20 mm miniature metric fuse; with indicator lamp; 230 V; 6.1 mm wide; gray



Item No.: 2004-911/1000-542
Fuse plug; with pull-tab; for 5 x 20 mm miniature metric fuse; with indicator lamp; 30 - 65 V; 6.1 mm wide; gray



Item No.: 2004-911
Fuse plug; with pull-tab; for miniature metric fuses 5 x 20 mm and 5 x 25 mm; without blown fuse indication; 6.1 mm wide; gray

1.2.8 Protective warning marker

1.2.8.1 Cover



Item No.: 2002-115
Protective warning marker; for 5 terminal blocks; with high-voltage symbol, black; yellow

1.2.9 Push-in type wire jumper

1.2.9.1 Jumper



Item No.: 2009-414
Push-in type wire jumper; 1.5 mm²; insulated; 110 mm long; black



Item No.: 2009-414/000-005
Push-in type wire jumper; 1.5 mm²; insulated; 110 mm long; black



Item No.: 2009-416
Push-in type wire jumper; 1.5 mm²; insulated; 250 mm long; black



Item No.: 2009-414/000-006
Push-in type wire jumper; insulated; 110 mm long; black



Item No.: 2009-412
Push-in type wire jumper; insulated; 60 mm long; black

1.2.10 Screwless end stop

1.2.10.1 Mounting accessories



Item No.: 249-117
Screwless end stop; 10 mm wide; for DIN-rail 35 x 15 and 35 x 7.5; gray



Item No.: 249-116
Screwless end stop; 6 mm wide; for DIN-rail 35 x 15 and 35 x 7.5; gray

1.2.11 Test and measurement

1.2.11.1 Testing accessories



Item No.: 210-136

Test plug; 2 mm Ø; with 500 mm cable; red

1.2.12 Tool

1.2.12.1 Operating tool



Item No.: 210-658

Operating tool; Blade: 3.5 x 0.5 mm; with a partially insulated shaft; angled; short; multicoloured



Item No.: 210-720

Operating tool; Blade: 3.5 x 0.5 mm; with a partially insulated shaft; multicoloured

Installation Notes

Conductor termination



All conductor types at a glance

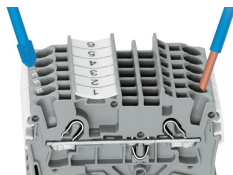

Push-in termination of solid and ferruled conductors

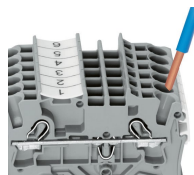

Inserting a conductor via push-in termination:
Solid conductors with cross-sections from either one size above, or up to two sizes below, the rated cross-section can be simply pushed in – no tools needed.

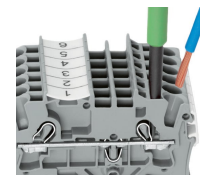

Inserting a conductor via operating tool:
Connecting fine-stranded conductors without ferrules, or small cross-sectional conductors that cannot be pushed in, is performed similarly to the original CAGE CLAMP® – just use an operating tool.
Advantage:
To open the clamp, the operating tool is inserted vertically. The conductor entry is less than 15 degrees for easier wiring.

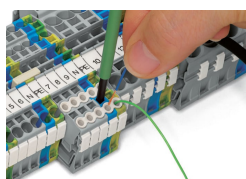

Conductor termination – insulation stop

Commoning

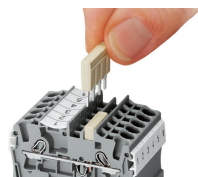

Insert push-in type jumper bar and push down until it hits backstop.

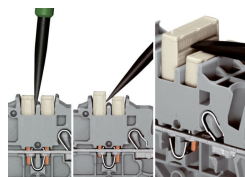

Removing a push-in type jumper bar:
Insert the operating tool between the jumper and partition wall of the dual jumper slots, then lift up the jumper. Place the operating tool in the center of jumpers for up to five contacts (see above), or alternately on both sides for jumpers with more than five contacts.

Commoning

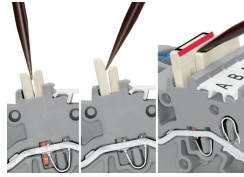
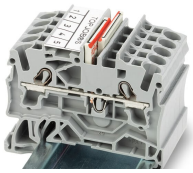

Orient the staggered jumpers' red stripes on the inside.
Insert the staggered jumper and push down until it hits the backstop.

Removing a staggered jumper:
Insert the operating tool between the staggered jumpers, then lift up the jumper.

Commoning

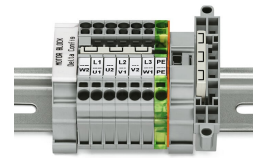
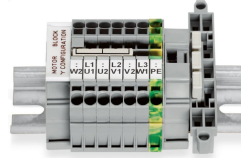
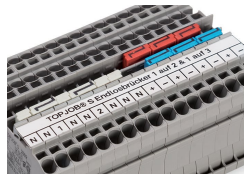

Continuous jumpers (2002 Series) readily connect an endless number of terminal blocks to each other via single jumper slot. Use the second jumper slot for additional commoning or testing.

The 1-to-3 adjacent jumper for continuous commoning enables every other terminal block to be commoned. For example, positive and negative potentials can be accommodated alongside each other.

This star point jumper has been specially developed to create a "star point" and is used on motor terminal boards equipped with Rail-Mount Terminal Blocks TOPJOB® S.

This delta jumper has been specially developed to create a delta configuration and is used on motor terminal boards equipped with rail-mount terminal blocks TOPJOB® S.

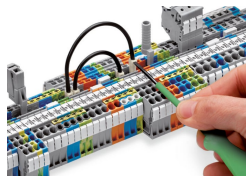

Push down the wire jumper until fully inserted. Lift the jumper with an operating tool for rewiring.

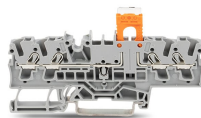
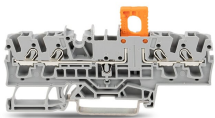

Carrier terminal block (Item No. 2002-1661) with disconnect plug (Item No. 2002-401) in operating position

Carrier terminal block (Item No. 2002-1661) with disconnect plug (Item No. 2002-401) in parked position

Marking

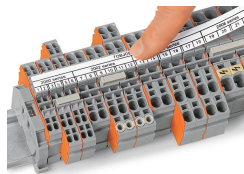
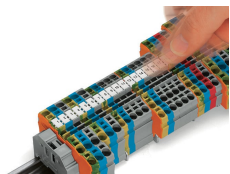

Snapping WMB Inline markers into marker slots.