

## Power MOSFET

PRODUCT SUMMARY		
$V_{DS}$ (V)	- 200	
$R_{DS(on)}$ ( $\Omega$ )	$V_{GS} = -10$ V	0.50
$Q_g$ (Max.) (nC)	44	
$Q_{gs}$ (nC)	7.1	
$Q_{gd}$ (nC)	27	
Configuration	Single	

### FEATURES

- Surface Mount
- Available in Tape and Reel
- Dynamic  $dV/dt$  Rating
- Repetitive Avalanche Rated
- P-Channel
- Fast Switching
- Ease of Paralleling
- Lead (Pb)-free Available



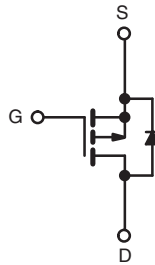
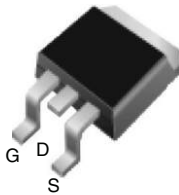
Available  
**RoHS\***  
COMPLIANT

### DESCRIPTION

Third generation Power MOSFETs from Vishay provide the designer with the best combination of fast switching, ruggedized device design, low on-resistance and cost-effectiveness.

The D<sup>2</sup>PAK (TO-263) is a surface mount power package capable of accommodating die size up to HEX-4. It provides the highest power capability and the lowest possible on-resistance in any existing surface mount package. The D<sup>2</sup>PAK (TO-263) is suitable for high current applications because of its low internal connection resistance and can dissipate up to 2.0 W in a typical surface mount application.

D<sup>2</sup>PAK (TO-263)



P-Channel MOSFET

ORDERING INFORMATION			
Package	D <sup>2</sup> PAK (TO-263)	D <sup>2</sup> PAK (TO-263)	D <sup>2</sup> PAK (TO-263)
Lead (Pb)-free	IRF9640SPbF	IRF9640STRLPbF <sup>a</sup>	IRF9640STRPbF <sup>a</sup>
	SiHF9640S-E3	SiHF9640STL-E3 <sup>a</sup>	SiHF9640STR-E3 <sup>a</sup>
SnPb	IRF9640S	IRF9640STRL <sup>a</sup>	IRF9640STR <sup>a</sup>
	SiHF9640S	SiHF9640STL <sup>a</sup>	SiHF9640STR <sup>a</sup>

#### Note

- a. See device orientation.

ABSOLUTE MAXIMUM RATINGS $T_C = 25$ °C, unless otherwise noted				
PARAMETER	SYMBOL		LIMIT	UNIT
Drain-Source Voltage	$V_{DS}$		- 200	V
Gate-Source Voltage	$V_{GS}$		$\pm 20$	
Continuous Drain Current	$V_{GS}$ at - 10 V	$I_D$	$T_C = 25$ °C	- 11
			$T_C = 100$ °C	- 6.8
Pulsed Drain Current <sup>a</sup>	$I_{DM}$		- 44	A
Linear Derating Factor			1.0	W/°C
Linear Derating Factor (PCB Mount) <sup>e</sup>			0.025	
Single Pulse Avalanche Energy <sup>b</sup>	$E_{AS}$		700	mJ
Avalanche Current <sup>a</sup>	$I_{AR}$		- 11	A
Repetitive Avalanche Energy <sup>a</sup>	$E_{AR}$		13	mJ
Maximum Power Dissipation	$T_C = 25$ °C		125	W
Maximum Power Dissipation (PCB Mount) <sup>e</sup>	$T_A = 25$ °C		3.0	
Peak Diode Recovery $dV/dt$ <sup>c</sup>	$dV/dt$		- 5.0	V/ns
Operating Junction and Storage Temperature Range	$T_J, T_{stg}$		- 55 to + 150	°C
Soldering Recommendations (Peak Temperature)	for 10 s		300 <sup>d</sup>	

#### Notes

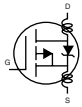
- Repetitive rating; pulse width limited by maximum junction temperature (see fig. 11).
- $V_{DD} = -50$  V, starting  $T_J = 25$  °C,  $L = 8.7$  mH,  $R_G = 25$   $\Omega$ ,  $I_{AS} = -11$  A (see fig. 12).
- $I_{SD} \leq -11$  A,  $dI/dt \leq 150$  A/ $\mu$ s,  $V_{DD} \leq V_{DS}$ ,  $T_J \leq 150$  °C.
- 1.6 mm from case.
- When mounted on 1" square PCB (FR-4 or G-10 material).

\* Pb containing terminations are not RoHS compliant, exemptions may apply

THERMAL RESISTANCE RATINGS				
PARAMETER	SYMBOL	TYP.	MAX.	UNIT
Maximum Junction-to-Ambient	$R_{thJA}$	-	62	°C/W
Maximum Junction-to-Ambient (PCB Mount) <sup>a</sup>	$R_{thJA}$	-	40	
Maximum Junction-to-Case (Drain)	$R_{thJC}$	-	1.0	

### Note

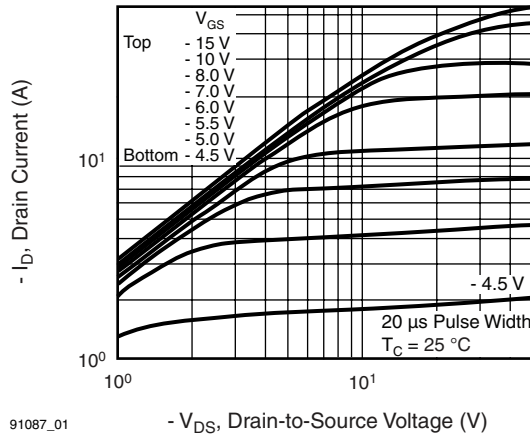
a. When mounted on 1" square PCB (FR-4 or G-10 material).

SPECIFICATIONS $T_J = 25\text{ }^\circ\text{C}$ , unless otherwise noted						
PARAMETER	SYMBOL	TEST CONDITIONS	MIN.	TYP.	MAX.	UNIT
<b>Static</b>						
Drain-Source Breakdown Voltage	$V_{DS}$	$V_{GS} = 0\text{ V}$ , $I_D = -250\text{ }\mu\text{A}$	-200	-	-	V
$V_{DS}$ Temperature Coefficient	$\Delta V_{DS}/T_J$	Reference to $25\text{ }^\circ\text{C}$ , $I_D = -1\text{ mA}$	-	-0.20	-	V/°C
Gate-Source Threshold Voltage	$V_{GS(th)}$	$V_{DS} = V_{GS}$ , $I_D = -250\text{ }\mu\text{A}$	-2.0	-	-4.0	V
Gate-Source Leakage	$I_{GSS}$	$V_{GS} = \pm 20\text{ V}$	-	-	$\pm 100$	nA
Zero Gate Voltage Drain Current	$I_{DSS}$	$V_{DS} = -200\text{ V}$ , $V_{GS} = 0\text{ V}$	-	-	-100	$\mu\text{A}$
		$V_{DS} = -160\text{ V}$ , $V_{GS} = 0\text{ V}$ , $T_J = 125\text{ }^\circ\text{C}$	-	-	-500	
Drain-Source On-State Resistance	$R_{DS(on)}$	$V_{GS} = -10\text{ V}$ , $I_D = 6.6\text{ A}^b$	-	-	0.50	$\Omega$
Forward Transconductance	$g_{fs}$	$V_{DS} = -50\text{ V}$ , $I_D = -6.6\text{ A}^b$	4.1	-	-	S
<b>Dynamic</b>						
Input Capacitance	$C_{iss}$	$V_{GS} = 0\text{ V}$ , $V_{DS} = -25\text{ V}$ , $f = 1.0\text{ MHz}$ , see fig. 5	-	1200	-	pF
Output Capacitance	$C_{oss}$		-	370	-	
Reverse Transfer Capacitance	$C_{rss}$		-	81	-	
Total Gate Charge	$Q_g$	$V_{GS} = -10\text{ V}$ , $I_D = -11\text{ A}$ , $V_{DS} = -160\text{ V}$ , see fig. 6 and 13 <sup>b</sup>	-	-	44	nC
Gate-Source Charge	$Q_{gs}$		-	-	7.1	
Gate-Drain Charge	$Q_{gd}$		-	-	27	
Turn-On Delay Time	$t_{d(on)}$	$V_{DD} = -100\text{ V}$ , $I_D = -11\text{ A}$ , $R_G = 9.1\text{ }\Omega$ , $R_D = 8.6\text{ }\Omega$ , see fig. 10 <sup>b</sup>	-	14	-	ns
Rise Time	$t_r$		-	43	-	
Turn-Off Delay Time	$t_{d(off)}$		-	39	-	
Fall Time	$t_f$		-	38	-	
Internal Drain Inductance	$L_D$	Between lead, 6 mm (0.25") from package and center of die contact	-	4.5	-	nH
Internal Source Inductance	$L_S$		-	7.5	-	
<b>Drain-Source Body Diode Characteristics</b>						
Continuous Source-Drain Diode Current	$I_S$	MOSFET symbol showing the integral reverse p - n junction diode	-	-	-11	A
Pulsed Diode Forward Current <sup>a</sup>	$I_{SM}$		-	-	-44	
Body Diode Voltage	$V_{SD}$	$T_J = 25\text{ }^\circ\text{C}$ , $I_S = -11\text{ A}$ , $V_{GS} = 0\text{ V}^b$	-	-	-5.0	V
Body Diode Reverse Recovery Time	$t_{rr}$	$T_J = 25\text{ }^\circ\text{C}$ , $I_F = -11\text{ A}$ , $dI/dt = 100\text{ A}/\mu\text{s}^b$	-	250	300	ns
Body Diode Reverse Recovery Charge	$Q_{rr}$		-	2.9	3.6	$\mu\text{C}$
Forward Turn-On Time	$t_{on}$	Intrinsic turn-on time is negligible (turn-on is dominated by $L_S$ and $L_D$ )				

### Notes

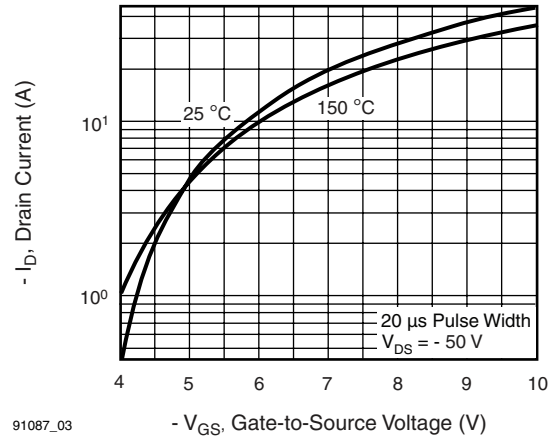
- Repetitive rating; pulse width limited by maximum junction temperature (see fig. 11).
- Pulse width  $\leq 300\text{ }\mu\text{s}$ ; duty cycle  $\leq 2\%$ .

## TYPICAL CHARACTERISTICS 25 °C, unless otherwise noted



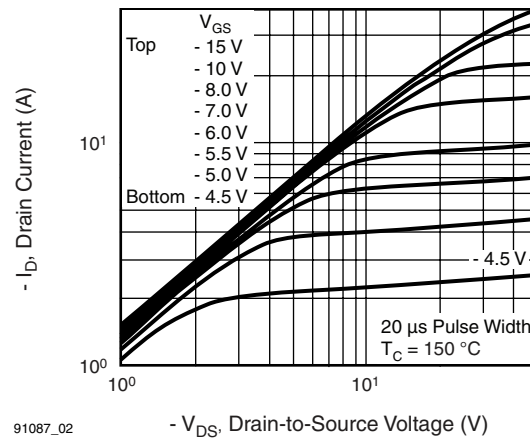
91087\_01

Fig. 1 - Typical Output Characteristics,  $T_C = 25\text{ }^\circ\text{C}$



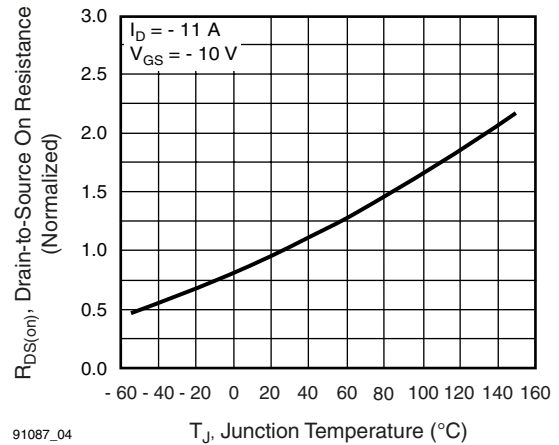
91087\_03

Fig. 3 - Typical Transfer Characteristics



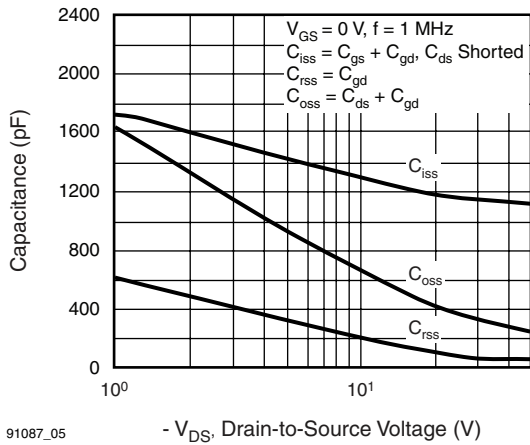
91087\_02

Fig. 2 - Typical Output Characteristics,  $T_C = 150\text{ }^\circ\text{C}$



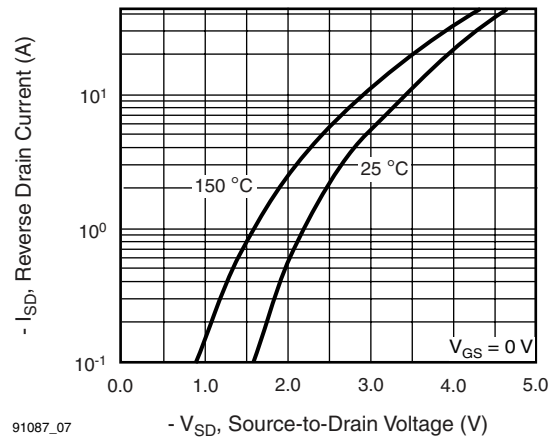
91087\_04

Fig. 4 - Normalized On-Resistance vs. Temperature



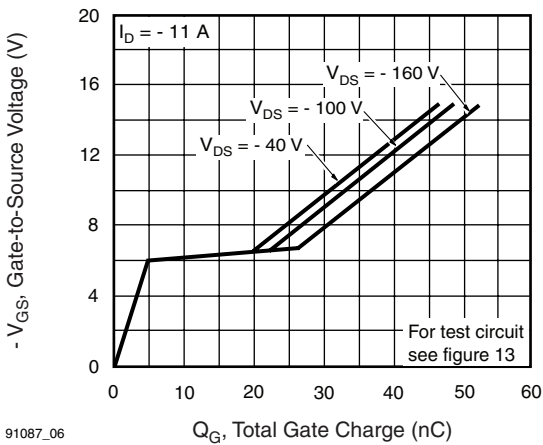
91087\_05

Fig. 5 - Typical Capacitance vs. Drain-to-Source Voltage



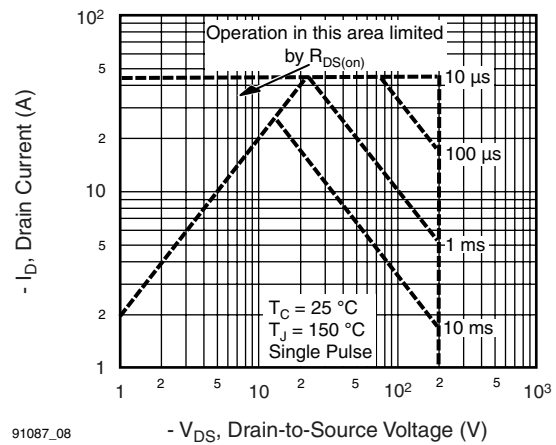
91087\_07

Fig. 7 - Typical Source-Drain Diode Forward Voltage



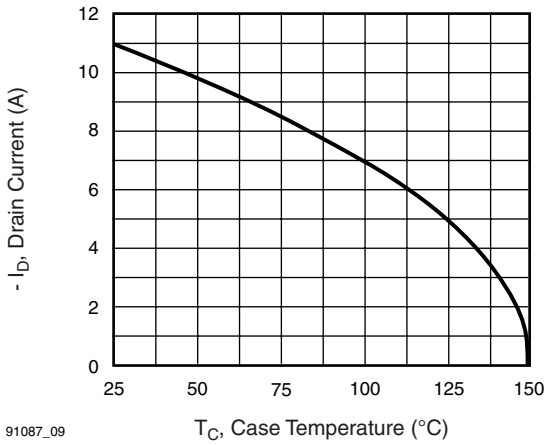
91087\_06

Fig. 6 - Typical Gate Charge vs. Gate-to-Source Voltage

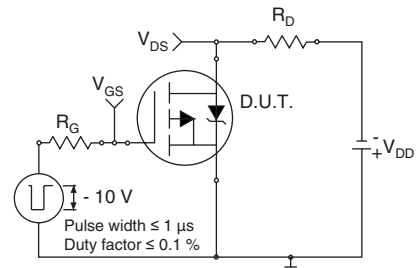


91087\_08

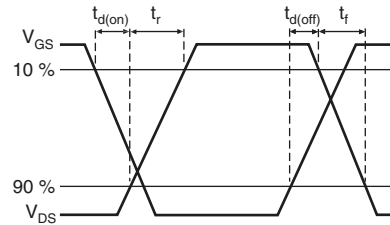
Fig. 8 - Maximum Safe Operating Area



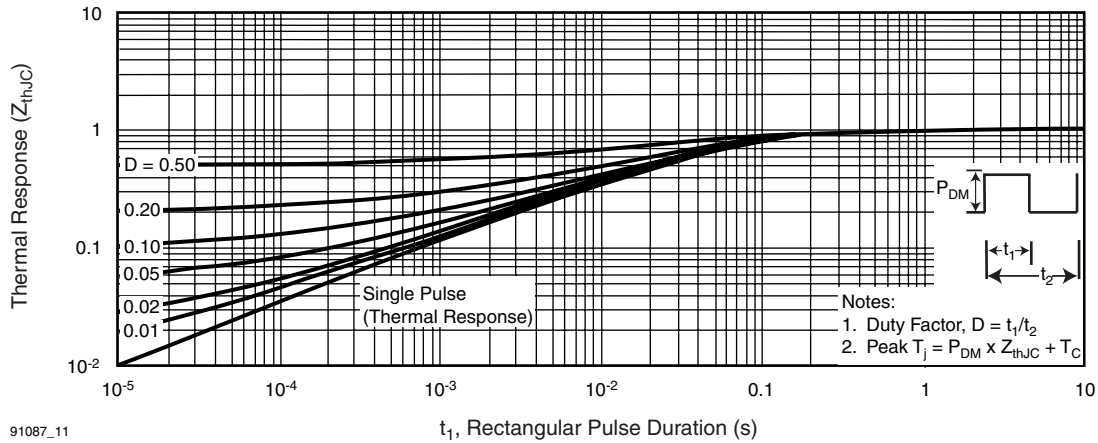
**Fig. 9 - Maximum Drain Current vs. Case Temperature**



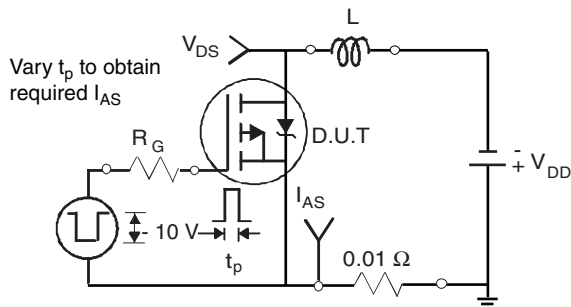
**Fig. 10a - Switching Time Test Circuit**



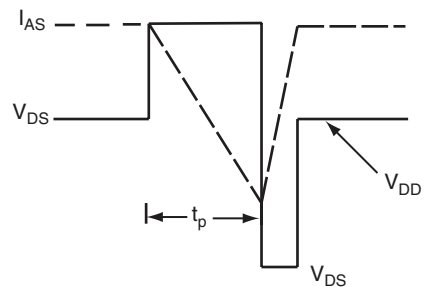
**Fig. 10b - Switching Time Waveforms**



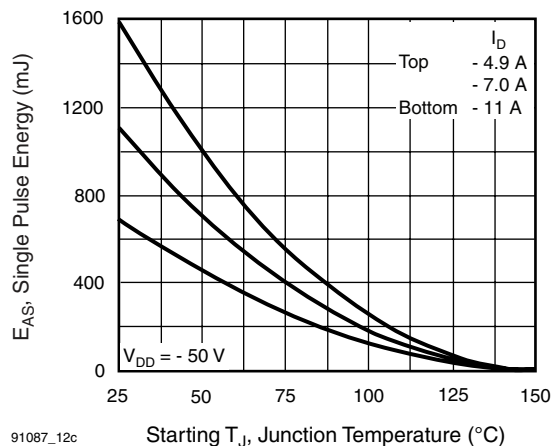
**Fig. 11 - Maximum Effective Transient Thermal Impedance, Junction-to-Case**



**Fig. 12a - Unclamped Inductive Test Circuit**

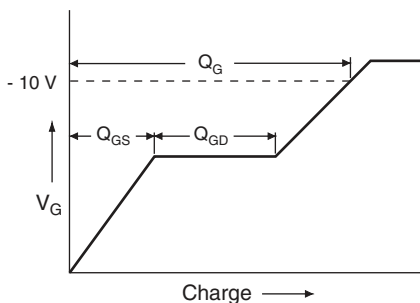


**Fig. 12b - Unclamped Inductive Waveforms**

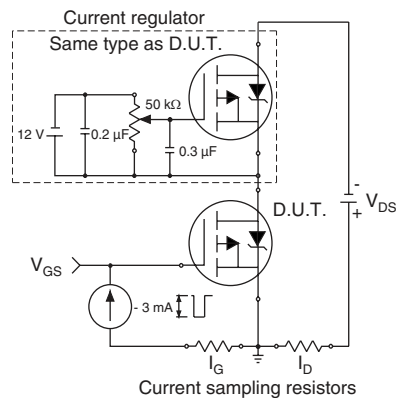


91087\_12c

**Fig. 12c - Maximum Avalanche Energy vs. Drain Current**

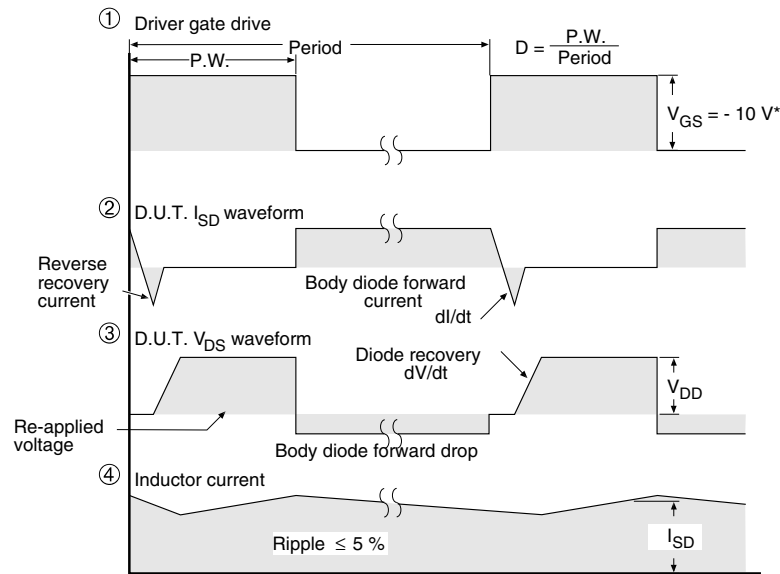
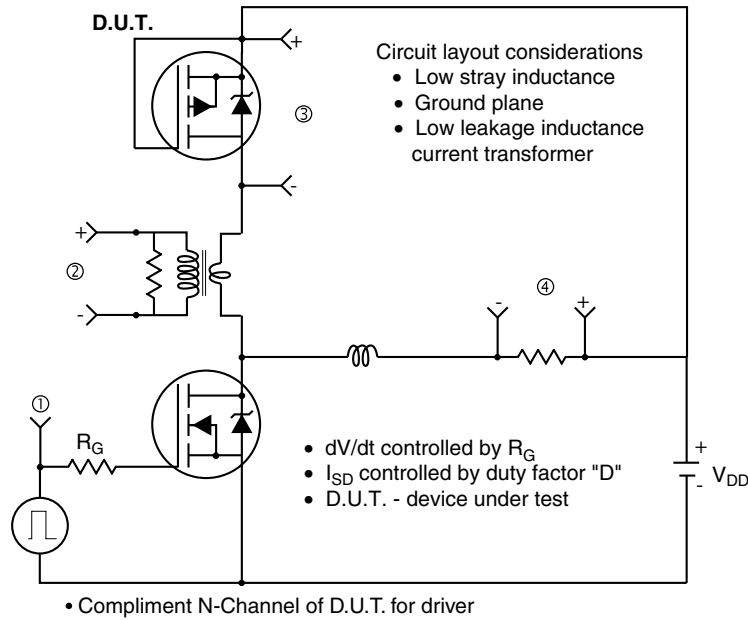


**Fig. 13a - Basic Gate Charge Waveform**



**Fig. 13b - Gate Charge Test Circuit**

## Peak Diode Recovery dV/dt Test Circuit



\*  $V_{GS} = -5 V$  for logic level and  $-3 V$  drive devices

**Fig. 14 - For P-Channel**

Vishay Siliconix maintains worldwide manufacturing capability. Products may be manufactured at one of several qualified locations. Reliability data for Silicon Technology and Package Reliability represent a composite of all qualified locations. For related documents such as package/tape drawings, part marking, and reliability data, see [www.vishay.com/ppg?91087](http://www.vishay.com/ppg?91087).



## Disclaimer

All product specifications and data are subject to change without notice.

Vishay Intertechnology, Inc., its affiliates, agents, and employees, and all persons acting on its or their behalf (collectively, "Vishay"), disclaim any and all liability for any errors, inaccuracies or incompleteness contained herein or in any other disclosure relating to any product.

Vishay disclaims any and all liability arising out of the use or application of any product described herein or of any information provided herein to the maximum extent permitted by law. The product specifications do not expand or otherwise modify Vishay's terms and conditions of purchase, including but not limited to the warranty expressed therein, which apply to these products.

No license, express or implied, by estoppel or otherwise, to any intellectual property rights is granted by this document or by any conduct of Vishay.

The products shown herein are not designed for use in medical, life-saving, or life-sustaining applications unless otherwise expressly indicated. Customers using or selling Vishay products not expressly indicated for use in such applications do so entirely at their own risk and agree to fully indemnify Vishay for any damages arising or resulting from such use or sale. Please contact authorized Vishay personnel to obtain written terms and conditions regarding products designed for such applications.

Product names and markings noted herein may be trademarks of their respective owners.