

**Interference Suppression Film Capacitors
MKP Radial Potted Type**

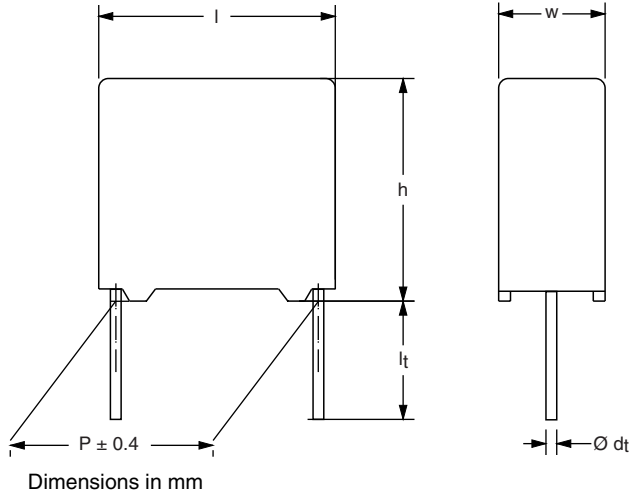

NO FOCUS PRODUCT: USE MKP 3381 X1

APPLICATIONS

X1 class

For X1 electromagnetic interference suppression in across the line applications (50/60 Hz) with a maximum mains voltage of 275 Vac

For application limitations please refer to section "Application Notes"

REFERENCE STANDARDS

"IEC 60384-14 2nd edition and EN 132400"

"IEC 60065, pass. flamm. class B"

250 V: CSA-C22.2 No 1; UL1414

275 V: UL1283; ENEC

MARKING

C-value; tolerance; rated voltage; sub-class; manufacturer's type designation; code for dielectric material, only for pitch ≥ 15 mm; manufacturer location; year and week

DIELECTRIC

Polypropylene film

ELECTRODES

Metallized film

CONSTRUCTION

Mono construction

FEATURES

15 mm to 27.5 mm lead pitch. Supplied loose in box taped on reel

Lead (Pb)-free product

RoHS compliant product



**RoHS
COMPLIANT**

RATED VOLTAGE

AC 275 V; 50 Hz to 60 Hz

PERMISSIBLE DC VOLTAGE

DC 630 V

ENCAPSULATION

Plastic case, epoxy resin sealed, flame retardant
UL-class 94 V-0

CLIMATIC TESTING CLASS ACC. TO EN 60068-1

55/105/56/B

CAPACITANCE RANGE (E12 SERIES)

E12 series 0.01 μ F to 1 μ F

Preferred values acc. to E6

CAPACITANCE TOLERANCE

± 20 %; ± 10 %; ± 5 %

LEADS

Tinned wire

RATED TEMPERATURE

105 °C

MAXIMUM APPLICATION TEMPERATURE

105 °C

DETAIL SPECIFICATION

For more detailed data and test requirements contact:

rfi@vishay.com



COMPOSITION OF CATALOG NUMBER

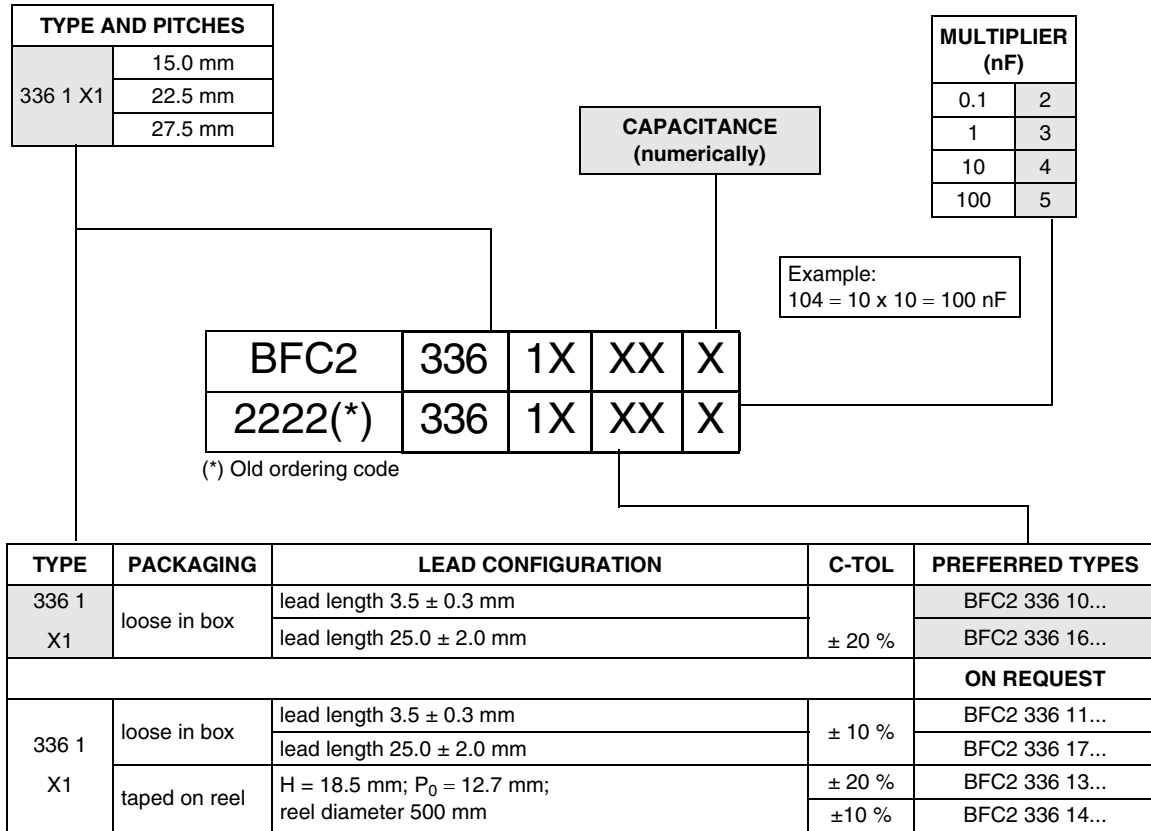

Note

(1) For detailed tape specifications refer to Packaging information www.vishay.com/docs/28139/packinfo.pdf

SPECIFIC REFERENCE DATA MKP 336 1 275 VAC

DESCRIPTION	VALUE
Tangent of loss angle:	at 10 kHz
C ≤ 100 nF	≤ 10 x 10 ⁻⁴
100 nF < C ≤ 470 nF	≤ 20 x 10 ⁻⁴
C > 470 nF	≤ 70 x 10 ⁻⁴
Rated voltage pulse slope (dU/dt) _R at 385 Vdc:	
P = 15 mm	250 V/μs
P = 22.5 mm	150 V/μs
P = 27.5 mm	100 V/μs
R between leads, for C ≤ 0.33 μF at 100 V; 1 minute	> 15 000 MΩ
RC between leads, for C > 0.33 μF at 100 V; 1 minute	> 5000 seconds
R between leads and case; 100 V; 1 minute	> 30 000 MΩ
Withstanding (DC) voltage (cut off current 10 mA); rise time 100 V/s	3400 V; 1 minute
Withstanding (AC) voltage between leads and case	2050 V; 1 minute

MKP 336 1 X1



Vishay BCcomponents Interference Suppression Film Capacitors MKP Radial Potted Type

MKP 336 1 GENERAL DATA

$U_{Rac} = 275 \text{ V}$; $C\text{-tol} = \pm 20 \%$

C (μF)	DIMENSIONS W x H x L (mm)	MASS (g) ⁽¹⁾	CATALOG NUMBER BFC2 336 1 AND PACKAGING					
			LOOSE IN BOX				REEL	
			$l_t = 3.5 \pm 0.3$		$l_t = 25.0 \pm 2.0 \text{ mm}$		$H = 18.5 \text{ mm}$; $P_0 = 12.7 \text{ mm}$	
			Last 5 digits of catalog number	SPQ	Last 5 digits of catalog number	SPQ	Last 5 digits of catalog number	SPQ
Pitch = $15.0 \pm 0.4 \text{ mm}$; $d_t = 0.6 \pm 0.06 \text{ mm}$								
0.01	5.0 x 11.0 x 17.5	1	19001	1000	19007	1000	19002	1100
0.015			10153		16153		13153	
0.022			10223		16223		13223	
0.033	6.0 x 12.0 x 17.5	1.4	10333		16333		13333	900
Pitch = $15.0 \pm 0.4 \text{ mm}$; $d_t = 0.8 \pm 0.08 \text{ mm}$								
0.047	7.0 x 13.5 x 17.5	1.8	10473	1000	16473	500	13473	800
0.068	8.5 x 15.0 x 17.5	2.4	10683		16683		13683	650
0.1	10.0 x 16.5 x 17.5	3	10104	500	16104		13104	600
Pitch = $22.5 \pm 0.4 \text{ mm}$; $d_t = 0.8 \pm 0.08 \text{ mm}$								
0.1	7.0 x 16.5 x 26.0	2.9	19003	200	19008	500	19004	550
0.15	8.5 x 18.0 x 26.0	3.8	10154		16154		13154	450
0.22	10.0 x 19.5 x 26.0	6.8	10224		16224		13224	400
Pitch = $27.5 \pm 0.4 \text{ mm}$; $d_t = 0.8 \pm 0.08 \text{ mm}$								
0.22	11.0 x 21.0 x 31.0	7.4	19005	100	19009	125		
0.33	13.0 x 23.0 x 31.0	9.2	10334		16334			
0.47	15.0 x 25.0 x 31.0	12.3	10474		16474			
0.68	18.0 x 28.0 x 31.0	16.1	10684		16684			
1	21.0 x 31.0 x 31.0	20.3	10105	50	16105	75		

Note

⁽¹⁾ Weight for short lead product only





U_{RAC} = 275 V; C-TOL = ± 10 %

C (µF)	DIMENSIONS W x H x L (mm)	MASS (g) ⁽¹⁾	CATALOG NUMBER BFC2 336 1..... AND PACKAGING					
			LOOSE IN BOX				REEL	
			It = 3.5 ± 0.3 m		It = 25.0 ± 2.0 mm		H = 18.5 mm; P ₀ = 12.7 mm	
			last 5 digits	SPQ	last 5 digits	SPQ	last 5 digits	SPQ
Pitch = 15.0 ± 0.4 mm; d_t = 0.6 ± 0.06 mm								
0.01	5.0 x 11.0 x 17.5	1	11103	1000	17103	1000	14103	1100
0.012			11123		17123		14123	
0.015			11153		17153		14153	
0.018			11183		17183		14183	
0.022	6.0 x 12.0 x 17.5	1.4	11223	1000	17223	1000	14223	900
0.027			11273		17273		14273	
Pitch = 15.0 ± 0.4 mm; d_t = 0.8 ± 0.08 mm								
0.033	7.0 x 13.5 x 17.5	1.8	11333	1000	17333	500	14333	800
0.039			11393		17393		14393	
0.047	8.5 x 15.0 x 17.5	2.4	11473		17473		14473	650
0.056			11563		17563		14563	
0.068	10.0 x 16.5 x 17.5	3	11683	500	17683	1000	14683	600
0.082			11823		17823		14823	
Pitch = 22.5 ± 0.4 mm; d_t = 0.8 ± 0.08 mm								
0.1	7.0 x 16.5 x 26.0	2.9	11104	200	17104	500	14104	550
0.12	8.5 x 18.0 x 26.0	3.8	11124		17124	250	14124	450
0.15			11154		17154	14154		
0.18	10.0 x 19.5 x 26.0	6.8	11184		17184	500	14184	400
Pitch = 27.5 ± 0.4 mm; d_t = 0.8 ± 0.08 m								
0.22	11.0 x 21.0 x 31.0	7.4	11224	100	17224	125	1000	1000
0.27			11274		17274			
0.33	13.0 x 23.0 x 31.0	9.2	11334		17334			
0.39	15.0 x 25.0 x 31.0	12.3	11394		17394			
0.47			11474		17474			
0.56	18.0 x 28.0 x 31.0	16.1	11564		17564			
0.68			11684	17684				
0.82	21.0 x 31.0 x 31.0	20.3	11824	50	17824	75	1000	1000

Note

⁽¹⁾ Weight for short lead product only

SAFETY APPROVALS X1	VOLTAGE	VALUE	FILE NUMBERS
EN132400	275 Vac	10 nF to 1 μF	FI 2006020
UL1414	250 Vac	10 nF to 1 μF	E112471
UL1283	275 Vac	10 nF to 1 μF	E109565
CSA-C22.2 No.1	250 Vac	10 nF to 1 μF	1104860
The EneC-approval together with the CB-Certificate replace all national marks of the following countries (they have already signed the ENEC-Agreement): Austria; Belgium; Czech. Republic; Denmark; Finland; France; Germany; Greece; Hungary; Ireland; Italy; Luxembourg; Netherlands; Norway; Portugal; Slovenian; Spain; Switzerland and United Kingdom.			
  			

MOUNTING

Normal Use

The capacitors are designed for mounting on printed-circuit boards. The capacitors packed in bandoliers are designed for mounting in printed-circuit boards by means of automatic insertion machines.

For detailed tape specifications refer to "Packaging information".

Specific Method of Mounting to Withstand Vibration and Shock

In order to withstand vibration and shock tests, it must be ensured that the stand-off pips are in good contact with the printed-circuit board:

- For pitches ≤ 15 mm capacitors shall be mechanically fixed by the leads
- For longer pitches the capacitors shall be mounted in the same way and the body clamped

Space Requirements on printed Circuit Board

The maximum length and width of film capacitors is shown in Figure:

- Eccentricity as in figure. The maximum eccentricity is smaller than or equal to the lead diameter of the product concerned
- Product height with seating plane as given by "IEC 60717" as reference: $h_{max.} \leq h + 0.3$ mm

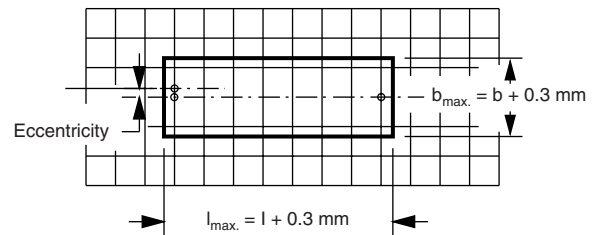

CBA116

Storage Temperature

- Storage temperature: $T_{stg} = -25$ °C to $+40$ °C with RH maximum 80 % without condensation

Ratings and Characteristics Reference Conditions

Unless otherwise specified, all electrical values apply to an ambient temperature of 23 °C ± 1 °C, an atmospheric pressure of 86 kPa to 106 kPa and a relative humidity of 50 % ± 2 %.

For reference testing, a conditioning period shall be applied over 96 hours ± 4 hours by heating the products in a circulating air oven at the rated temperature and a relative humidity not exceeding 20 %.



CHARACTERISTICS

Capacitance

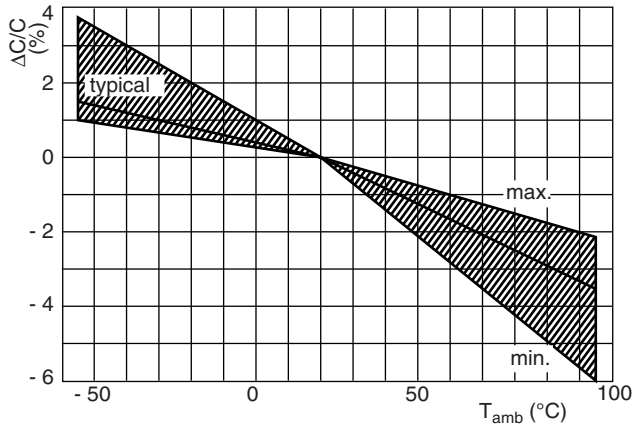

Tangent of loss angle

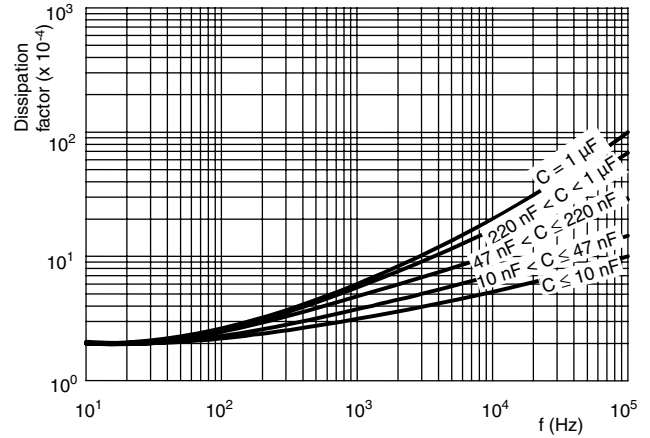

Impedance

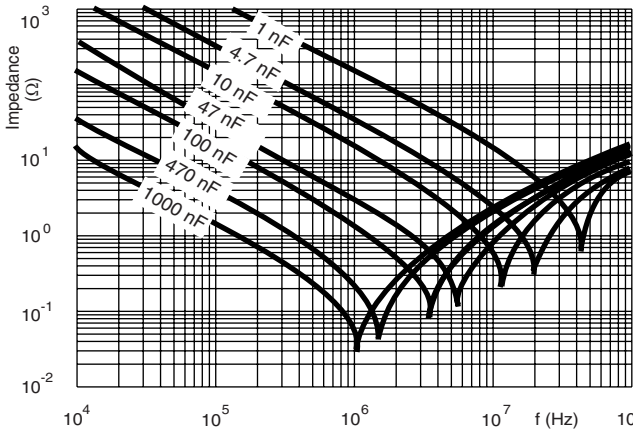

Resonant frequency

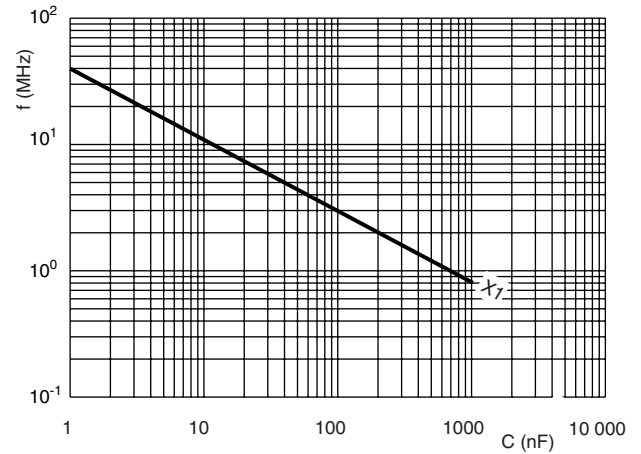

Max RMS voltage and AC current (sinewave)

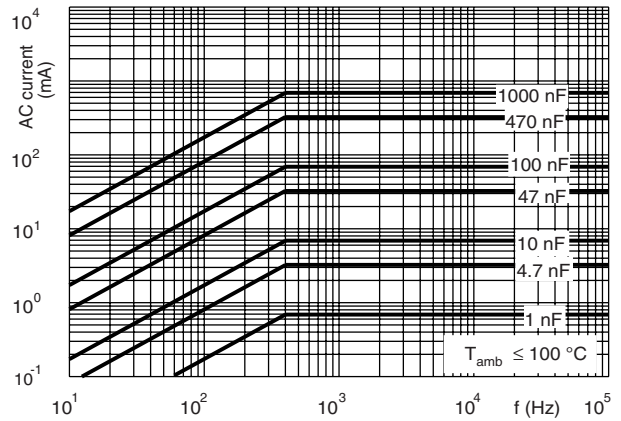
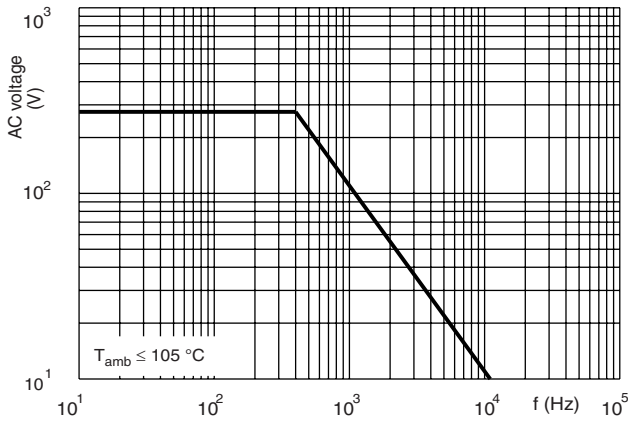



CHARACTERISTICS

Capacitance

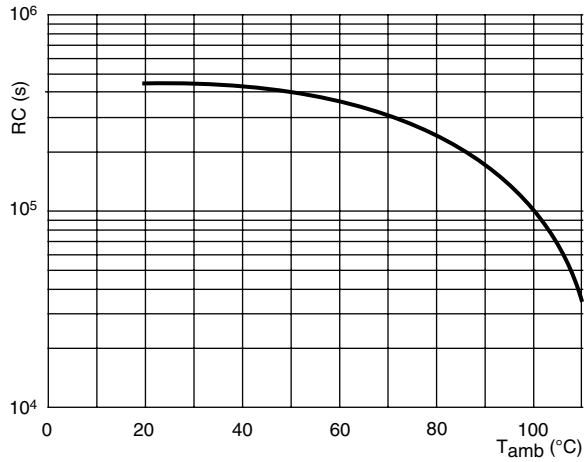

APPLICATION NOTES

- For X1 electromagnetic interference suppression in **across the line applications** (50/60 Hz) with a maximum mains voltage of 275 Vac.
- These capacitors are not intended for continuous pulse applications. For these situations, capacitors of the AC and pulse programs must be used.
- These capacitors are not intended for series impedance application. For these situations in case safety approvals are requested, please refer to our special capacitors of 1772 series with internal series connection.
- The maximum ambient temperature must not exceed 105 °C.
- Rated voltage pulse slope:
If the pulse voltage is lower than the rated voltage, the values of the specific reference data can be multiplied by 385 Vdc and divided by the applied voltage.



Interference Suppression Film Capacitors Vishay BCcomponents
MKP Radial Potted Type

INSPECTION REQUIREMENTS

General Notes:

- Sub-clause numbers of tests and performance requirements refer to the “ Sectional Specification, IEC-publication EN 132400 (IEC 60384-14) and section One of this specification”.
- In this table: D = destructive
ND = non destructive

Group C inspection requirements

SUB - CLAUSE NUMBER AND TEST	D OR ND	CONDITIONS	PERFORMANCE REQUIREMENTS
SUB-GROUP C1A PART OF SAMPLE OF SUB-GROUP C1	D		
4.1 Dimensions (detail) Initial measurements		Capacitance Tangent of loss angle: For C ≤ 470 nF at 100 kHz For C > 470 nF at 10 kHz	As specified in Chapters “General data” of this specification
4.3 Robustness of terminations		Tensile: load 10 N; 10 seconds Bending: load 5 N; 4 x 90°	No visible damage
4.4 Resistance to soldering heat		No pre-drying Method: 1A Solder bath: 260 °C Duration: 10 seconds	
4.19 Component solvent resistance		Isopropylalcohol at room temperature Method: 2 Immersion time: 5 ± 0.5 minutes Recovery time: Min. 1 hour, max. 2 hours	
4.4.2 Final measurements		Visual examination Capacitance Tangent of loss angle Insulation resistance	No visible damage Legible marking $ \Delta C/C \leq 5\%$ of the value measured initially Increase of tan δ : ≤ 0.0100 for: C ≤ 100 nF or ≤ 0.0200 for: 100 nF < C ≤ 470 nF or ≤ 0.0080 for: C > 470 nF Compared to values measured initially As specified in Section “Insulation Resistance” of this specification
SUB - GROUP C1B PART OF SAMPLE OF SUB - GROUP C1	D		
Initial measurements		Capacitance Tangent of loss angle: For C ≤ 470 nF at 100 kHz For C > 470 nF at 10 kHz	No visible damage Legible marking
4.20 Solvent resistance of the marking: see Section “General notes”; item 5		Isopropylalcohol at room temperature Method: 1 Rubbing material: cotton wool Immersion time: 5 ± 0.5 minutes	No visible damage
4.6 Rapid change of temperature		$\theta A = - 55\text{ }^\circ\text{C}$ $\theta B = + 105\text{ }^\circ\text{C}$ 5 cycles	
4.6.1 Inspection		Duration t = 30 minutes	



Interference Suppression Film Capacitors Vishay BCcomponents
MKP Radial Potted Type

SUB - CLAUSE NUMBER AND TEST	D OR ND	CONDITIONS	PERFORMANCE REQUIREMENTS
4.7 Vibration (see note 3.1) 4.7.2 Final inspection 4.9 Shock (see note 3) 4.9.2 Final measurements		Visual examination Mounting: see Section "Mounting" of this specification Procedure B4: Frequency range: 10 Hz to 55 Hz Amplitude: 0.75 mm or Acceleration 98 m/s ² (whichever is less severe) Total duration 6 hours Visual examination Mounting: see Section "Mounting" for more information Pulse shape: half sine Acceleration: 490 m/s ² Duration of pulse: 11 ms Visual examination Capacitance Tangent of loss angle Insulation resistance	No visible damage No visible damage No visible damage $ \Delta C/C \leq 5\%$ of the value measured initially Increase of $\tan \delta$: ≤ 0.0100 for: $C \leq 100$ nF or ≤ 0.0200 for: 100 nF < $C \leq 470$ nF or ≤ 0.0080 for: $C > 470$ nF Compared to values measured initially As specified in Section "Insulation Resistance" of this specification
SUB - GROUP C1 COMBINED SAMPLE OF SPECIMENS OF SUB - GROUPS C1A AND C1B	D		
4.11 Climatic sequence 4.11.1 Initial measurements 4.11.2 Dry heat 4.11.3 Damp heat cyclic Test Db First cycle 4.11.4 Cold 4.11.5 Damp heat cyclic Test Db remaining cycles 4.11.6 Final measurements		Capacitance Measured in 4.4.2 and 4.9.2 Tangent of loss angle: Measured initially in C1A and C1B Temperature: 105 °C Duration: 16 hours Temperature: - 55 °C Duration: 2 hours Visual examination Capacitance Tangent of loss angle Voltage proof 1200 Vdc; 1 minute between term Insulation resistance	No visible damage Legible marking $ \Delta C/C \leq 5\%$ of the value measured in 4.11.1. Increase of $\tan \delta$: ≤ 0.0100 for: $C \leq 100$ nF or ≤ 0.0200 for: 100 nF < $C \leq 470$ nF or ≤ 0.0080 for: $C > 470$ nF Compared to values measured in 4.11.1 No permanent breakdown or flash-over $\geq 50\%$ of values specified in Section "Insulation resistance" of this specification



Interference Suppression Film Capacitors Vishay BCcomponents
MKP Radial Potted Type

SUB - CLAUSE NUMBER AND TEST	D OR ND	CONDITIONS	PERFORMANCE REQUIREMENTS
SUB - GROUP C2	D		
4.12 Damp heat steady state 4.12.1 Initial measurements 4.12.3 Final measurements		56 days, 40 °C, 90 % to 95 % RH, no load Capacitance Tangent of loss angle at 10 kHz Visual examination Capacitance Tangent of loss angle Voltage proof 1200 Vdc; 1 minute between term Insulation resistance	No visible damage Legible marking $ \Delta C/C \leq 5\%$ of the value measured in 4.12.1. Increase of tan δ : ≤ 0.0080 Compared to values measured in 4.12.1. No permanent breakdown or flash-over $\geq 50\%$ of values specified in Section "Insulation resistance" of this specification
SUB GROUP C3	D		
4.13.1 Initial measurements 4.13 Impulse voltage 4.14 Endurance 4.14.7 Final measurements		Capacitance Tangent of loss angle: For C ≤ 470 nF at 100 kHz For C > 470 nF at 10 kHz 3 successive impulses, full wave, peak voltage: X1: 4 kV Max. 24 pulses Duration: 1000 hours 1.25 U _{RAC} at 105 °C Once in every hour the voltage is increased to 1000 V (RMS) for 0.1 s via resistor of 47 $\Omega \pm 5\%$ Visual examination Capacitance Tangent of loss angle Voltage proof 1200 Vdc; 1 minute between terminations. 2050 Vdc; 1 minute between terminations and case. Insulation resistance	No selfhealing breakdowns or flashover No visible damage Legible marking $ \Delta C/C \leq 10\%$ compared to values measured in 4.13.1. Increase of tan δ : ≤ 0.0100 for: C ≤ 100 nF or ≤ 0.0200 for: 100 nF $< C \leq 470$ nF or ≤ 0.0080 for: C > 470 nF Compared to values measured in 4.13.1. No permanent breakdown or flash-over $\geq 50\%$ of values specified in Section "Insulation resistance" of this specification

Interference Suppression Film Capacitors Vishay BCcomponents
MKP Radial Potted Type

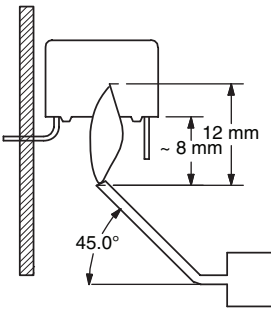
SUB - CLAUSE NUMBER AND TEST	D OR ND	CONDITIONS	PERFORMANCE REQUIREMENTS
SUB - GROUP C 4	D		
4.15 Charge and discharge 4.15.1 Initial measurements 4.15.3 Final measurements		10 000 cycles (50 c/s) charge to UR half sinewave Duration: 5 ms Discharge resistance: $R = \frac{385 \text{ Vdc}}{1.5 \times C((dU)/(dt))}$ $R_{\text{min.}} = 2.2$ Capacitance Tangent of loss angle For C ≤ 470 nF at 100 kHz For C > 470 nF at 10 kHz Capacitance Tangent of loss angle Insulation resistance	$ \Delta C/C \leq 10 \%$ compared to values measured in 4.15.1. Increase of tan δ: ≤ 0.0100 for: C ≤ 100 nF or ≤ 0.0200 for: 100 nF < C ≤ 470 nF or ≤ 0.0080 for: C > 470 nF Compared to values measured in 4.15.1 ≥ 50 % of values specified in Section "Insulation resistance" of this specification
SUB - GROUP C5	D		
4.16 Radio frequency characteristic		Resonance frequency	As specified in Section "Resonant frequency" of this specification. ± 10 %
SUB - GROUP C6	D		
4.17 Passive flammability Class B		Bore of gas jet: Ø 0.5 mm Fuel: butane Test duration for actual volume V in mm ³ : V ≤ 250: 10 s 250 < V ≤ 500: 20 seconds 500 < V ≤ 1750: 30 seconds V > 1750: 60 seconds One flame application 	After removing test flame from capacitor, the capacitor must not continue to burn for more than 10 seconds. No burning particle must drop from the sample.
SUB - GROUP C7	D		
4.18 Active flammability		20 x 4 kV discharges on the test capacitor connected to U _R	The cheese cloth around the capacitors shall not burn with a flame. No electrical measurements are required.



Disclaimer

All product specifications and data are subject to change without notice.

Vishay Intertechnology, Inc., its affiliates, agents, and employees, and all persons acting on its or their behalf (collectively, "Vishay"), disclaim any and all liability for any errors, inaccuracies or incompleteness contained herein or in any other disclosure relating to any product.

Vishay disclaims any and all liability arising out of the use or application of any product described herein or of any information provided herein to the maximum extent permitted by law. The product specifications do not expand or otherwise modify Vishay's terms and conditions of purchase, including but not limited to the warranty expressed therein, which apply to these products.

No license, express or implied, by estoppel or otherwise, to any intellectual property rights is granted by this document or by any conduct of Vishay.

The products shown herein are not designed for use in medical, life-saving, or life-sustaining applications unless otherwise expressly indicated. Customers using or selling Vishay products not expressly indicated for use in such applications do so entirely at their own risk and agree to fully indemnify Vishay for any damages arising or resulting from such use or sale. Please contact authorized Vishay personnel to obtain written terms and conditions regarding products designed for such applications.

Product names and markings noted herein may be trademarks of their respective owners.