

- Y5U Ceramic
- Radial Lead
- High CV
- +125°C Maximum Temperature

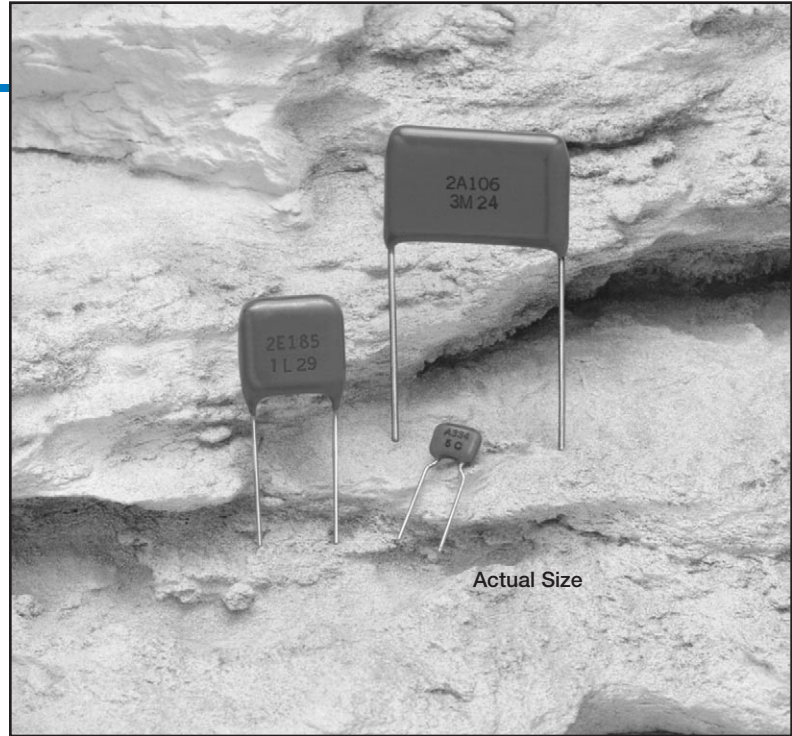

The TCD series are radial lead ceramic capacitors from UCC/NCC. These capacitors have a very low ESR and impedance which makes these capacitors ideal for filtering switching power supplies and DC-DC converters. The TCD series has a maximum 250VDC rated voltage making them more applicable for use in higher voltage power supplies than our ceramic chip capacitors. All of our radial capacitors with 5mm lead spacing are also available with ammo pack taping.

Refer to Mini-Glossary at the end of the multilayer ceramic capacitors section for additional technical information and specifications.

Summary of Specifications

- Radial lead terminals.
- Capacitance range: 0.1 to 100 μ F.
- Voltage range: 25 to 250VDC.
- Operating temperature range: -55°C to +125°C.
- Standard capacitance tolerance: $\pm 20\%$ or -20% to +80%
- Nominal case size (L \times W \times H): 5.0 \times 3.5 \times 6.0mm to 28.5 \times 8.5 \times 20.0mm.
- Rated lifetime: 1,000 hours at +125°C.

TCD Series

TCD Specifications

Item	Characteristics
Operating Temperature Range	-55 to +125°C
Rated Voltage Range	25 to 250VDC
Capacitance Range	0.1 to 100 μ F
Capacitance Tolerance	$\pm 20\%$ (M) or -20% to $+80\%$ (Z) at $+20 \pm 2^\circ\text{C}$, $1 \pm 0.1\text{kHz}$, and $1 \pm 0.2\text{Vrms}$
Dissipation Factor (Tan δ)	2.5% maximum at $+20 \pm 2^\circ\text{C}$, $1 \pm 0.1\text{kHz}$, and $1 \pm 0.2\text{Vrms}$
Ripple Current	At $+125^\circ\text{C}$, the maximum ripple current at 10kHz - 1MHz is specified in the Ratings Tables.
Withstand Voltage	No abnormality after applying 250% of the DC rated voltage from terminal-to-terminal and terminal-to-resin coating for 1 to 5 seconds at $+20 \pm 2^\circ\text{C}$.
Insulation Resistance	1,000 $\Omega \cdot \text{F}$ or 10,000M Ω , whichever is less, after applying the DC rated voltage for 60 ± 5 seconds at $+20 \pm 2^\circ\text{C}$.
Solderability	Using H60A or H63A solder at a solder temperature of $+235 \pm 5^\circ\text{C}$ and a dip time of 2 ± 0.5 seconds, a minimum of 75% of the circumferential surface of the dipped lead wires shall be covered with new solder.
Soldering Heat Resistance	Using H60A or H63A solder at a solder temperature of $+350 \pm 10^\circ\text{C}$ and a dip time of 3 ± 0.5 seconds at a depth of 2 to 2.5mm from the resin coating, the following specifications shall be satisfied when the capacitors are restored to $+20^\circ\text{C}$. Appearance : no abnormality Capacitance change : $\leq \pm 15\%$ of initial measured value Tan δ (DF) : $\leq 2.5\%$
Humidity Load Life Test	The following specifications shall be satisfied when the capacitors are restored to $+20^\circ\text{C}$ after applying the DC rated voltage for $500+24,-0$ hours at $+40 \pm 2^\circ\text{C}$, 90-95% RH. After the initial load test, the withstand voltage shall be tested by applying 250% of the DC rated voltage for 5 seconds. Appearance : no abnormality Capacitance change : $\leq \pm 20\%$ of initial measured value Tan δ (DF) : $\leq 5\%$ Insulation resistance : 50 $\Omega \cdot \text{F}$ or 1,000M Ω , whichever is less
Load Life Test	The following specifications shall be satisfied when the capacitors are restored to $+20^\circ\text{C}$ after applying 200% of the DC rated voltage for $1,000+48,-0$ hours at $+85 \pm 2^\circ\text{C}$, or $1,000+48,-0$ hours at $+125 \pm 3^\circ\text{C}$ with the initial DC rated voltage applied. After the initial load test, the withstand voltage shall be tested by applying 250% of the DC rated voltage for 5 seconds. Appearance : no abnormality Capacitance change : $\leq \pm 20\%$ of initial measured value Tan δ (DF) : $\leq 5\%$ Insulation resistance : 100 $\Omega \cdot \text{F}$ or 1,000M Ω , whichever is less

Part Numbering System for TCD Series

When ordering, always specify complete catalog number for TCD Series.

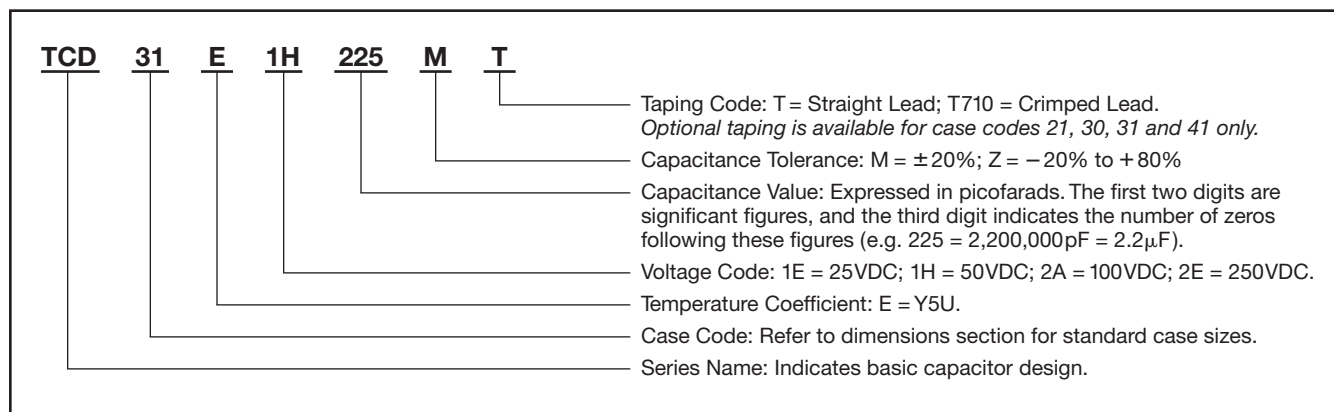

TCD Series

Construction and Diagram of Dimensions

Radial Lead Multilayer Ceramic

Unit: mm

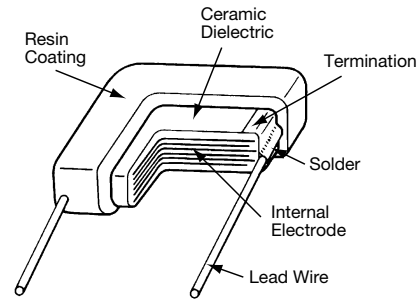
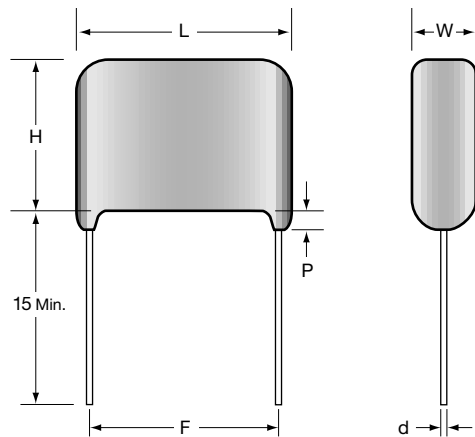

Case Dimensions

UCC Case Code	L max.	W max.	H max.	P max.	F ±0.8	ød ±0.05
21	5.0	3.5	4.5	1.5	5.0	0.5
30	6.3	4.0	5.0	1.5	5.0	0.5
31	7.5	4.0	7.5	1.5	5.0	0.5
41	10.0	5.0	10.0	1.5	5.0	0.5
51	13.5	5.5	13.5	1.5	10.0	0.6
60	22.5	8.5	17.5	2.5	20.0	0.8
61	28.5	8.5	17.5	2.5	25.0	0.8

Standard Voltage Ratings - Radial Lead Multilayer Ceramic

Rated Voltage (WVDC)	Capacitance (µF)	Catalog Part Number †	UCC Case Code*	Maximum Ripple Current (A rms) at +125°C, 10kHz-1MHz
25 Volts	0.68	TCD21E1E684M	21	0.3
	1.0	TCD21E1E105M	21	0.3
	1.5	TCD30E1E155M	30	0.8
	2.2	TCD30E1E225M	30	0.8
	3.3	TCD31E1E335M	31	1.0
	4.7	TCD31E1E475M	31	1.0
	6.8	TCD41E1E685M	41	1.5
	10	TCD41E1E106M	41	1.5
	15	TCD51E1E156M	51	2.0
	22	TCD51E1E226M	51	2.0
	33	TCD60E1E336M	60	3.0
	47	TCD60E1E476M	60	3.0
50 Volts	0.1	TCD21E1H104M	21	0.11
	0.15	TCD21E1H154M	21	0.16
	0.22	TCD21E1H224M	21	0.24
	0.33	TCD21E1H334M	21	0.3
	0.47	TCD21E1H474M	21	0.3
	0.68	TCD30E1H684M	30	0.75
	1.0	TCD30E1H105M	30	0.8
	1.5	TCD31E1H155M	31	1.0
	2.2	TCD31E1H225M	31	1.0
	3.3	TCD31E1H335M	31	1.0
	4.7	TCD41E1H475M	41	1.5
	6.8	TCD41E1H685M	41	1.5
10	TCD51E1H106M	51	2.0	
15	TCD51E1H156M	51	2.0	
22	TCD60E1H226M	60	3.0	

† M indicates ±20% tolerance. Substitute code letter Z in part number for -20%, +80% tolerance.

* Refer to diagram of dimensions for actual case sizes.

TCD Series

Standard Voltage Ratings - Radial Lead Multilayer Ceramic

Rated Voltage (WVDC)	Capacitance (μF)	Catalog Part Number †	UCC Case Code*	Maximum Ripple Current (A rms) at +125°C, 10kHz-1MHz
50 Volts	33	TCD60E1H336M	60	3.0
	47	TCD61E1H476M	61	4.0
	68	TCD61E1H686M	61	4.0
100 Volts	0.1	TCD21E2A104M	21	0.22
	0.15	TCD21E2A154M	21	0.3
	0.22	TCD21E2A224M	21	0.3
	0.33	TCD30E2A334M	30	0.73
	0.47	TCD30E2A474M	30	0.8
	0.68	TCD31E2A684M	31	1.0
	1.0	TCD31E2A105M	31	1.0
	1.5	TCD31E2A155M	31	1.0
	2.2	TCD41E2A225M	41	1.5
	3.3	TCD41E2A335M	41	1.5
	4.7	TCD51E2A475M	51	2.0
	6.8	TCD51E2A685M	51	2.0
	10	TCD60E2A106M	60	3.0
	15	TCD60E2A156M	60	3.0
22	TCD61E2A226M	61	4.0	
33	TCD61E2A336M	61	4.0	
250 Volts	0.1	TCD30E2E104M	30	0.55
	0.15	TCD30E2E154M	30	0.8
	0.22	TCD31E2E224M	31	1.0
	0.33	TCD31E2E334M	31	1.0
	0.47	TCD41E2E474M	41	1.5
	0.68	TCD41E2E684M	41	1.5
	1.0	TCD51E2E105M	51	2.0
	1.5	TCD51E2E155M	51	2.0
	2.2	TCD60E2E225M	60	3.0
	3.3	TCD60E2E335M	60	3.0
	4.7	TCD61E2E475M	61	4.0
	6.8	TCD61E2E685M	61	4.0

† M indicates ±20% tolerance. Substitute code letter Z in part number for -20%, +80% tolerance.

* Refer to diagram of dimensions for actual case sizes.

Ammo Pack Taping Specifications

Radial Lead Multilayer Ceramics
Available for Case Codes 21, 30, 31 and 41
Conforms to JIS-C-0805
Ammo Pack

Unit: mm

Dimensions and Quantity Per Box

UCC Case Code	21	30	31	41
H max. Straight Lead	23	24	26	29
H max. Crimped Lead	25	26	28	30
H ₀ ± 0.5	16.0	16.0	16.0	16.0
P ± 1.0	12.7	12.7	12.7	12.7
P ₀ ± 0.3	12.7	12.7	12.7	12.7
P ₁ ± 0.7	3.85	3.85	3.85	3.85
P _{0/2} ± 1.3	6.35	6.35	6.35	6.35
F ± 1.0	5.0	5.0	5.0	5.0
W - 0.5, +1.0	18.0	18.0	18.0	18.0
W/2 ± 0.5	9.0	9.0	9.0	9.0
M ± 1.0	13.0	13.0	13.0	13.0
M ₀ ± 1.5	1.5	1.5	1.5	1.5
øD ± 0.2	4.0	4.0	4.0	4.0
ød ± 0.05	0.5	0.5	0.5	0.5
t ± 0.2	0.6	0.6	0.6	0.6
Δh ± 2	0	0	0	0
Pieces Per Box*	2,000	2,000	2,000	1,500

*Specified quantity may vary for rating of capacitor.

TCD Series

Capacitance and DF Variation with Temperature and Applied DC Voltage

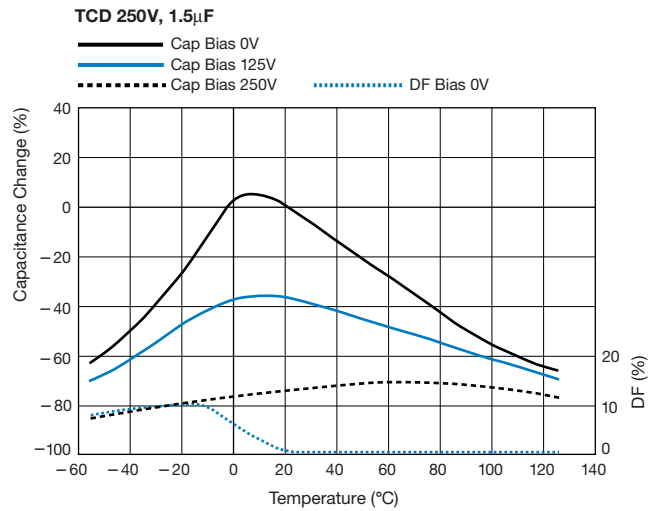
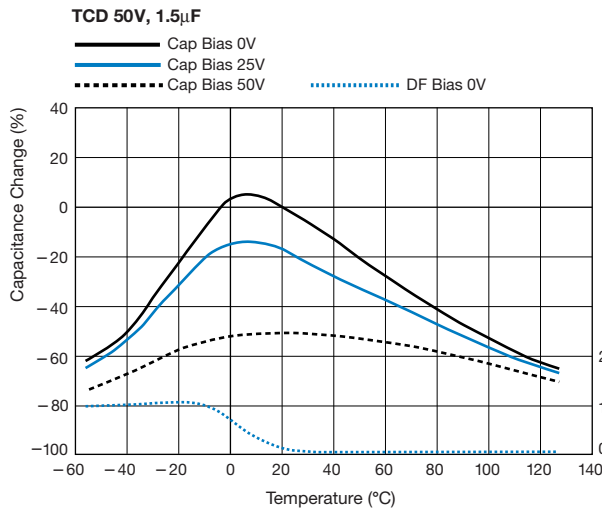
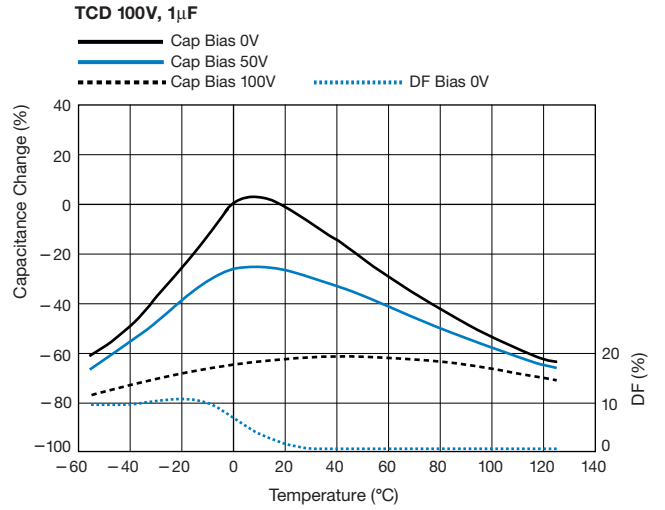
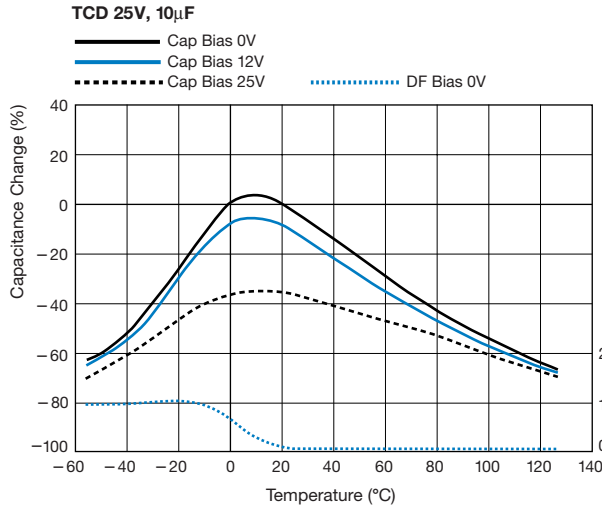

Impedance/ESR – Frequency Characteristics

