

NOTES

- MATERIAL & FINISH  
CONTACT: COPPER ALLOY  
Au PL. ON Pd-Ni PL. AT CONTACT AREA OVER Ni PL.  
MATTE TIN PL. AT TINE AREA OVER Ni PL.  
HOUSING: THERMO-PLASTICS: UL94V-0  
SHELL: COPPER ALLOY, TIN PL.
- GENERAL TOLERANCE  
10 ±0.2  
30 ±0.25  
100 ±0.3  
ANGLES: 45°
- MATERIAL/PARTS WHICH ARE CONTAINED THE PROHIBITION SUBSTANCE FOR ENVIRONMENTAL RELATED SUBSTANCE CONTROL STANDARD EN-022 (ENVIRONMENT RELATED SUBSTANCE) MUST NOT USE IN PRODUCT AND MANUFACTURING PROCESS
- CADMIUM CONTENT: 5ppm UNDER

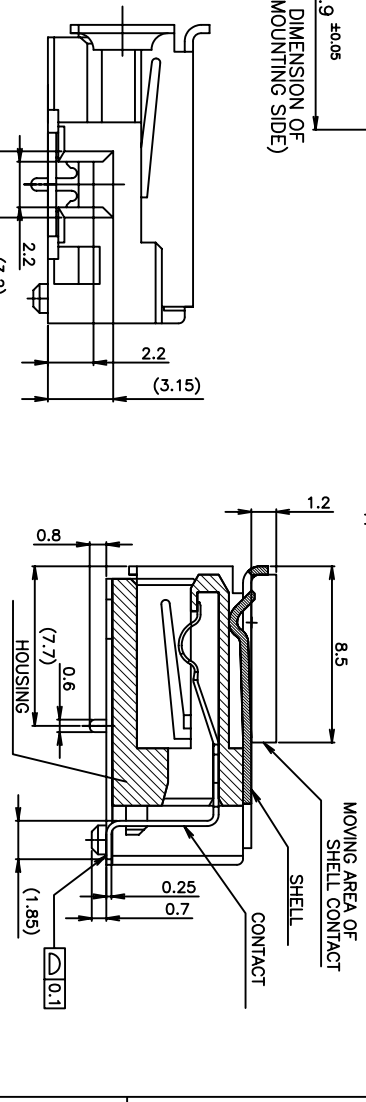

SECTION A-A  
5353583-1,2

WITH TAPE	BLACK	1-5353583-4
WITH OUT TAPE	BLACK	5353583-4
PRELIMINARY NOT FOR PRODUCTION	WHITE	5353583-3
PRELIMINARY NOT FOR PRODUCTION	BLACK	5353583-2
WITH TAPE	WHITE	1-5353583-1
WITH OUT TAPE	WHITE	5353583-1

THIS DRAWING IS A CONTROLLED DOCUMENT.

APPROVED: T. SASAKI  
PRODUCT SPEC.

DATE: 23MAR04

DRW: J. JIANG  
CHK: S. YAO

TYCO ELECTRONICS CORPORATION  
SHANGHAI, P.R. CHINA, 200233

RECEPTACLE ASS'Y R/A SMT  
STANDARD TYPE USB CONNECTOR

SIZE: A3  
CAGE CODE: 00779  
DRAWING NO: 5353583

SCALE: 4:1  
SHEET: 1 OF 2  
REV: A

LOC	DIST	REV	DATE	BY	APP'D
ES	00				

REV	DESCRIPTION	DATE	BY	APP'D
1	SEE SHEET 1			

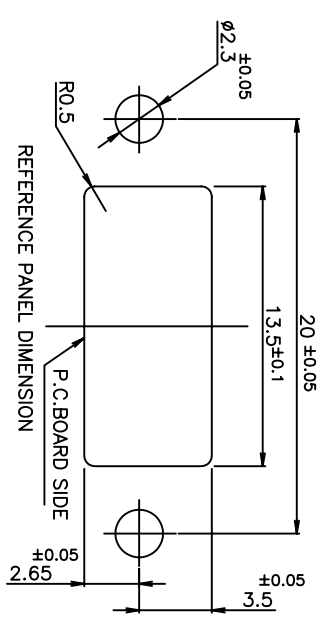
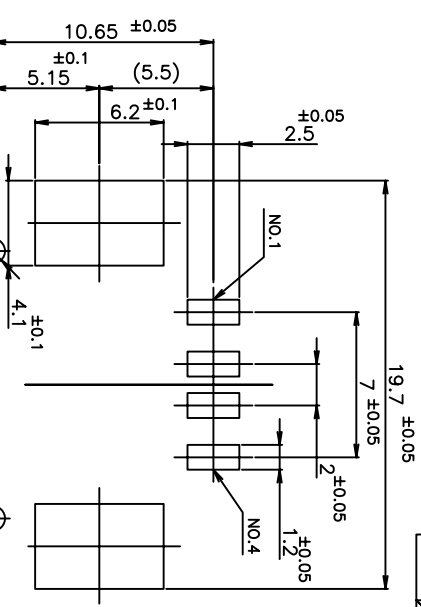
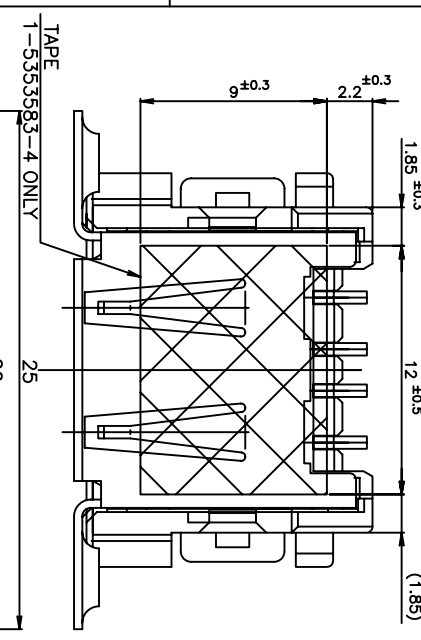

REFERENCE DIMENSION OF P.C. BOARD (MOUNTING SIDE)

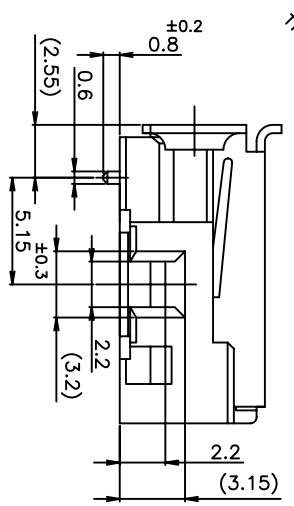
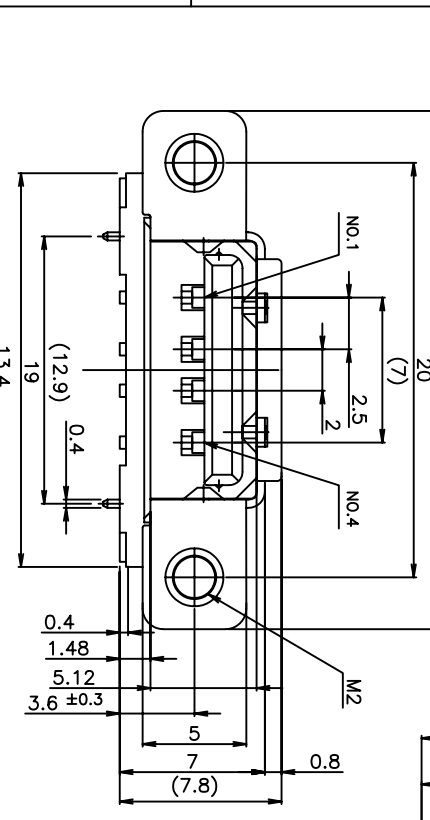

- 1. MATERIAL & FINISH  
CONTACT: COPPER ALLOY  
Au PL. ON Pd-Ni PL. AT CONTACT AREA OVER Ni PL.  
MATE TIN PL. AT THE AREA OVER Ni PL.  
HOUSING: THERMO-PLASTICS U194V-0  
SHELL : COPPER ALLOY, TIN PL.
- 2. GENERAL TOLERANCE  
102: ±0.2  
302 >10-±0.25  
1002 >30-±0.3  
ANGLES: ±5°
- 3. MATERIAL /PARTS WHICH ARE CONTAINED THE PROHIBITION SUBSTANCE FOR ENVIRONMENTAL RELATED SUBSTANCE CONTROL STANDARD EN-022 (ENVIRONMENT RELATED SUBSTANCE) MUST NOT USE IN PRODUCT AND MANUFACTURING PROCESS
- 4. CADMIUM CONTENT: 5ppm UNDER

5353583-3,4

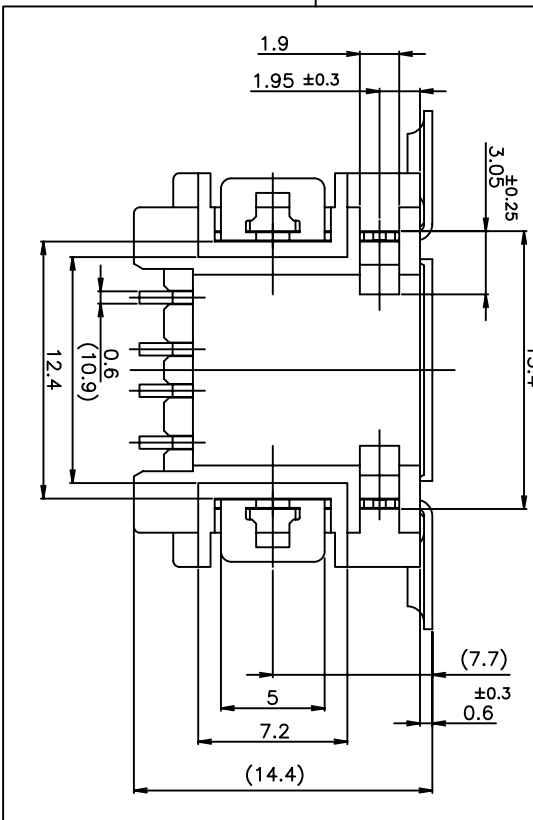

THIS DRAWING IS A CONTROLLED DOCUMENT.

DIMENSIONS:	MM	TOLERANCES UNLESS OTHERWISE SPECIFIED:
0 P.L.C.		±
1 P.L.C.		±
2 P.L.C.		±
3 P.L.C.		±
4 P.L.C.		±
ANGLES		±

DMN	CHK	APD	NAME
			<b>tyco</b> Tyco Electronics Corporation Shanghai, P.R.China, 200233

PRODUCT SPEC	APPLICATION SPEC	WEIGHT	CUSTOMER DRAWING
///	///	///	///

SIZE	CAGE CODE	DRAWING NO.	RESTRICTED
A3	00779	5353583	NO

RECEPTACLE ASS'Y R/A SMT  
STANDARD TYPE USB CONNECTOR