

SSC (Sealed Sensor Connector) System (Continued)

Plug Assemblies

Material and Finish:

Housing—Glass-filled PBT

Seal Ring—Silicone

Double-Lock Plate—PBT, yellow

One Position

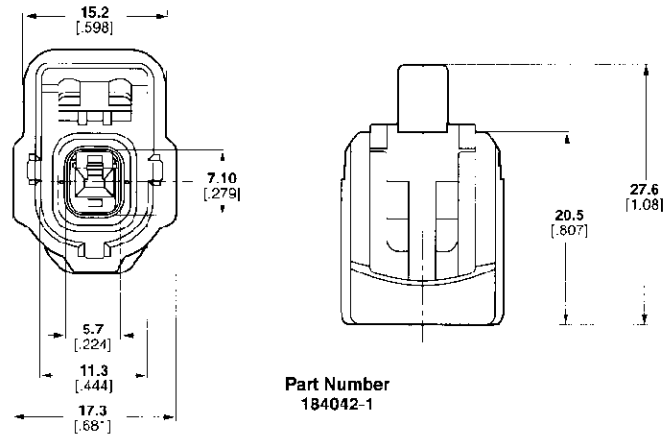

Two Position

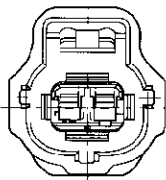
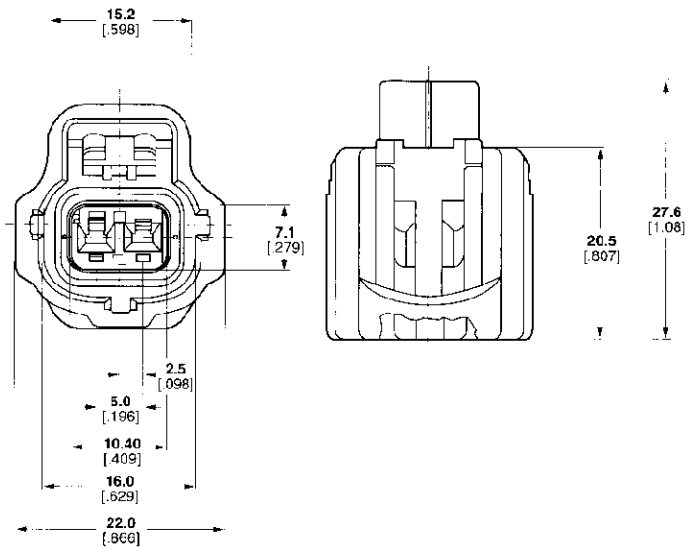

184000-1
BLACK, KEY A

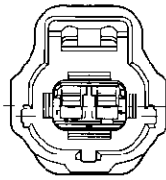

184002-1
GRAY, KEY B

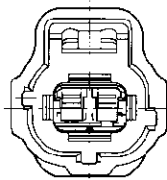

184004-1
BLACK, KEY C

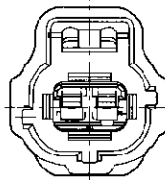

184006-1
GREEN, KEY D

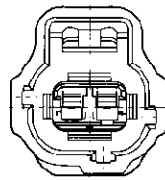

184008-1
BLACK, KEY E

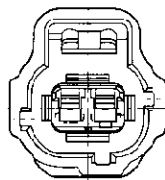

184010-1
BLACK, KEY F

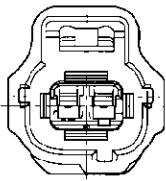

184012-1
GREY, KEY G

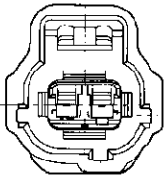

184014-1
BLACK, KEY H
184014-2
GREEN, KEY H
184014-3
BROWN, KEY H

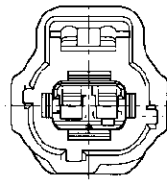

184016-1
BLACK, KEY J

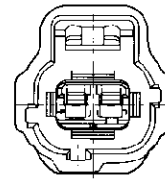

184018-1
BLACK, KEY K

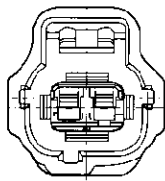

184020-1
NATURAL, KEY L

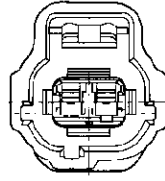

184022-1
BLACK, KEY M