

Compact RFI Filter with IEC Connector for Higher Frequency Applications

EJT Series



**UL Recognized
CSA Certified
VDE Approved***



EJT Series

The EJT Series is a power inlet filter designed to attenuate noise up to 1 GHz. This inlet uses an IEC 320C14 input connector which gives it a maximum rating of 15 amps. The EJT series is flange-mounted with optional outputs of 1/4" terminals or wire leads. This product was designed to address the demand for more noise attenuation at higher frequencies in a compact inlet. Now also available with an IEC 320C20 connector with a maximum rating of 20 amps.

*15EJT - VDE rated at 10amps, 250 VAC
20EJT - VDE rated at 16amps, 250 VAC

Electrical Schematics

1-15 Amp

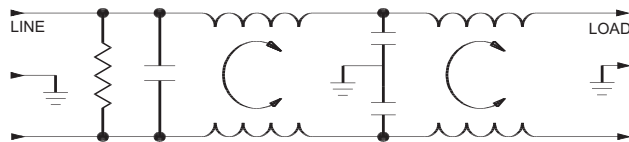

20 Amp

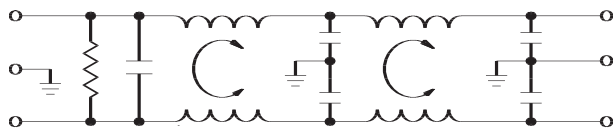

Resistor location for reference only.

Specifications

Maximum leakage current, each line-to-ground

	1-15 Amp	20 Amp
@ 120 VAC 60 Hz:	.22 mA	.20 mA
@ 250 VAC 50 Hz:	.38 mA	.40 mA

Hipot rating (one minute):

line-to-ground	2250 VDC	1500 VAC
line-to-line	1450 VDC	1450 VDC

Operating frequency:

50/60 Hz

Rated voltage (max.):

250 VAC

Minimum insertion loss in dB:

Line-to-ground in 50 ohm circuit

Current Rating	Frequency-MHz							
	.15	.5	1	5	10	30	100	1000
1A	27	33	40	59	65	65	61	14
3A	22	30	34	57	63	69	61	10
6A	13	21	27	51	60	65	59	14
10A	7	14	21	43	52	61	61	14
15A	4	10	15	38	48	63	63	14
20A	-	8	15	42	50	60	58	14

Line-to-line in 50 ohm circuit

Current Rating	Frequency-MHz							
	.15	.5	1	5	10	30	100	1000
1A	10	20	23	43	52	65	45	14
3A	10	20	24	41	51	59	52	17
6A	10	21	24	37	48	65	55	20
10A	10	21	25	28	44	63	53	18
15A	10	20	26	25	36	56	45	23
20A	9	20	26	40	35	48	50	10

EJT Series

Case Styles

EJT1

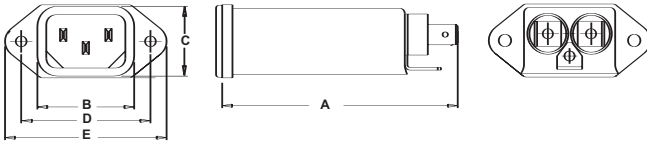

EJT8

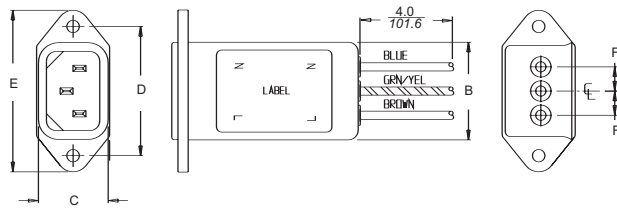

Typical dimensions:
Wire Leads:

4.0 [101.6] Min. - 18 AWG

20EJT1

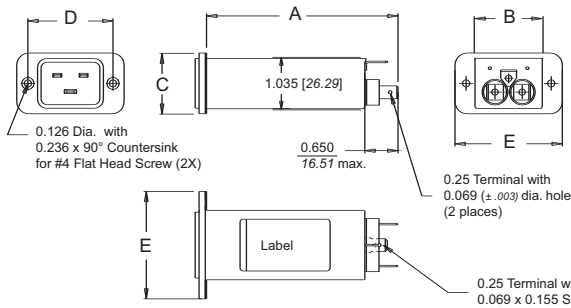

20EJT8

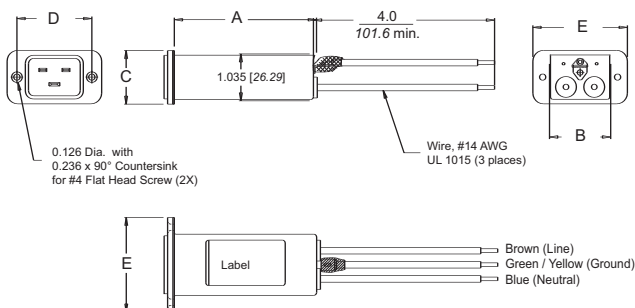

Case Dimensions

Part No.	A (max)	B (max)	C (max)	D (max)	E (max)	F (max)
1-15A EJT1	2.87 72.9	1.19 30.2	0.875 22.2	1.575 40.0	1.98 50.3	—
1-15A EJT8	2.23 56.6	1.19 30.2	0.875 22.2	1.575 40.0	1.98 50.3	0.295 7.5
20EJT1	3.8 96.52	1.350 34.29	1.18 29.99	1.654 42.01	2.087 53.00	—
20EJT8	3.2 81.28	1.350 34.29	1.18 29.99	1.654 42.01	2.087 53.00	—

Part Numbers

1EJT1	1EJT8
3EJT1	3EJT8
6EJT1	6EJT8
10EJT1	10EJT8
15EJT1	15EJT8
20EJT1	20EJT8
Line Cord No.	GA 400

Recommended Panel Cutout

1 to 15 Amp

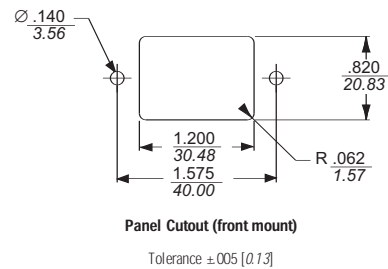

20 Amp

