

THIS DRAWING IS UNPUBLISHED. RELEASED FOR PUBLICATION
 © COPYRIGHT BY TYCO ELECTRONICS CORPORATION. ALL INTERNATIONAL RIGHTS RESERVED.

LOC	DIST	REVISIONS					
FT	0	P	LTR	DESCRIPTION	DATE	DWN	APVD
			D2	REVISED PER ECO-08-030621	13FEB09	HMR	CR

MATERIAL:
 HOUSING: THERMOPLASTIC POLYESTER, UL94V-0, BLACK
 LEVER: THERMOPLASTIC, UL94V-0, WHITE, UNLESS OTHERWISE NOTED.
 TERMINAL: BRIGHT ACID TIN OVER COPPER ALLOY

ELECTRICAL:
 MAXIMUM CURRENT: 10A
 OPERATING VOLTAGE: 150/300V (LIMITED RATINGS)
 WIRE RANGE: 16-22 STRANDED ONLY

ENVIRONMENTAL:
 MAX OPERATING TEMP: 130°C

- 1 MARKED WITH WHITE PERMANENT INK.
- 2 SUITABLE FOR STRANDED WIRE ONLY, 16-22 AWG. DO NOT USE FUSED OR TINNED WIRED

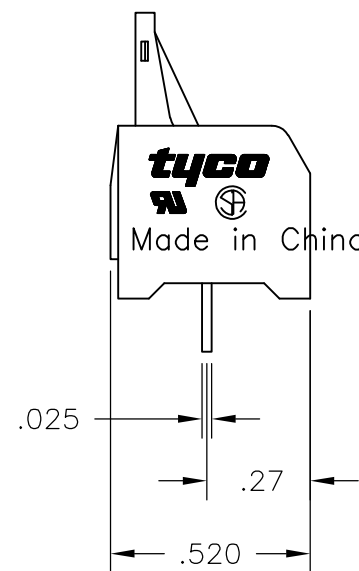
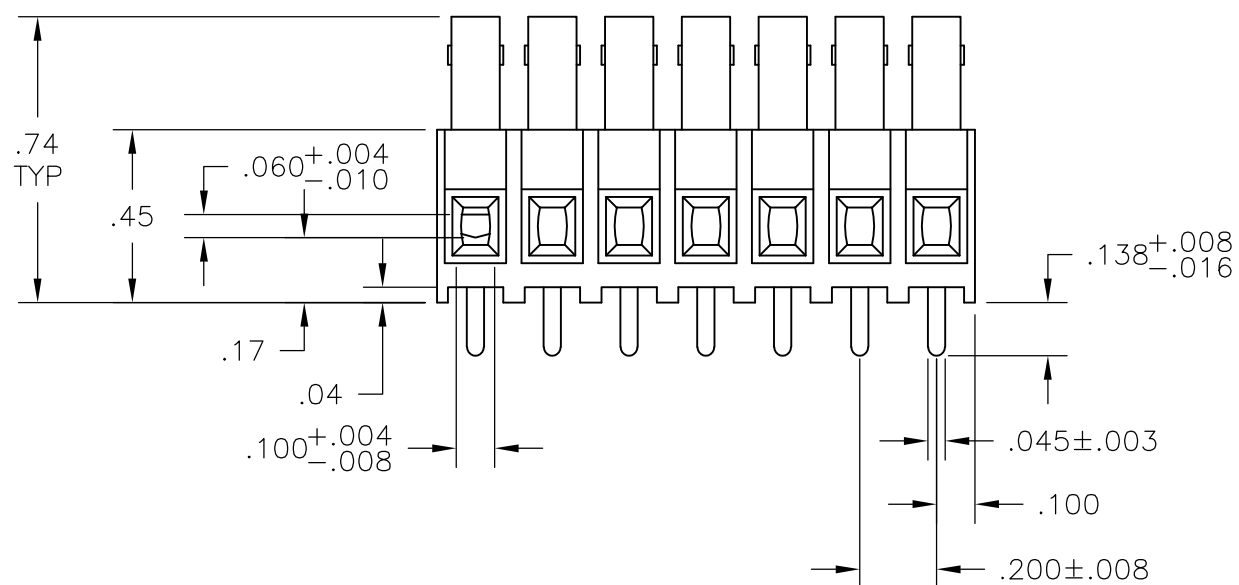
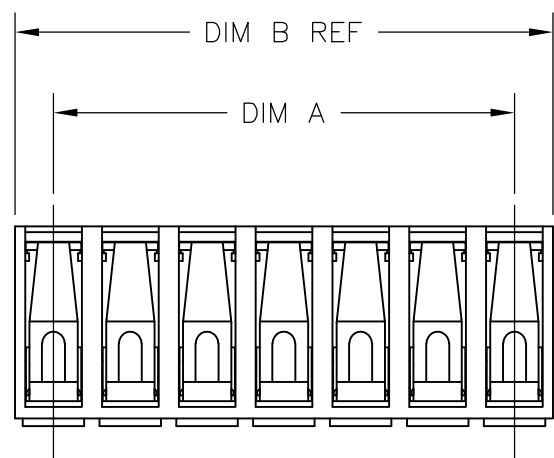

2SV-07 AS SHOWN

SEE FIGURE 1
 SEE FIGURE 1

SEE FIGURE

3.20	3.000	16	2SV-16	2-1437671-1
3.00	2.800	15	2SV-15	2-1437671-0
2.80	2.600	14	2SV-14	1-1437671-9
2.60	2.400	13	-	1-1437671-8
2.60	2.400	13	-	1-1437671-7
2.60	2.400	13	2SV-13	1-1437671-6
2.40	2.200	12	2SV-12	1-1437671-5
2.20	2.000	11	2SV-11	1-1437671-4
2.00	1.800	10	2SV-10	1-1437671-3
1.80	1.600	9	2SV-09	1-1437671-2
1.60	1.400	8	2SV-08	1-1437671-1
1.40	1.200	7	2SV-07	1-1437671-0
1.20	1.000	6	2SV-06	1437671-9
1.00	.800	5	2SV-05	1437671-7
.80	.600	4	2SV-04	1437671-6
.60	.400	3	2SV-03	1437671-4
.40	.200	2	-	1437671-2
.40	.200	2	2SV-02	1437671-1
DIM B REF	DIM A	NO. OF POS.	CATALOG NUMBER	TE NUMBER

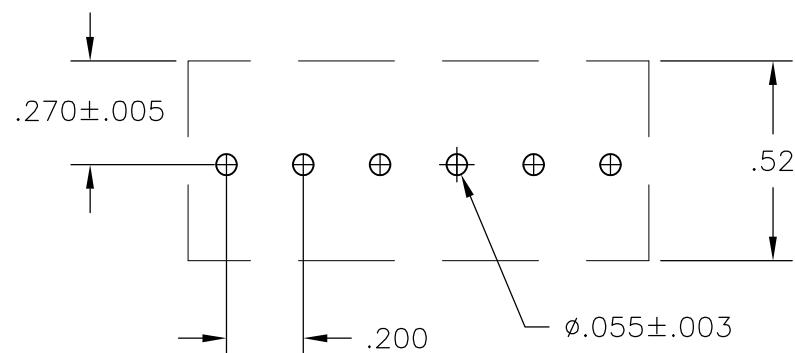

RECOMMENDED BOARD LAYOUT

THIS DRAWING IS A CONTROLLED DOCUMENT.		DWN	S SCHLEGEL	14JUN02	Tyco Electronics Corporation Harrisburg, PA 17105-3608		
DIMENSIONS: INCHES		CHK	C RICHARD	1/22/03	Tyco Electronics		
TOLERANCES UNLESS OTHERWISE SPECIFIED:		APVD	C RICHARD	1/22/03	NAME		
0 PLC ± -		PRODUCT SPEC		2SV 5.08mm SCREWLESS			
1 PLC ± -		APPLICATION SPEC		SIZE			
2 PLC ± .01		WEIGHT		A3		CAGE CODE	00779
3 PLC ± .010		CUSTOMER DRAWING		DRAWING NO		G-1437671-1	
4 PLC ± -		SCALE		NTS		SHEET	
ANGLES ± ±		RESTRICTED TO		1 OF 2		REV	
MATERIAL		FINISH		D2			

THIS DRAWING IS UNPUBLISHED.

RELEASED FOR PUBLICATION

LOC

DIST

REVISIONS

© COPYRIGHT - BY TYCO ELECTRONICS CORPORATION. ALL INTERNATIONAL RIGHTS RESERVED.

FT

0

P

LTR

DESCRIPTION

DATE

DWN

APVD

SEE SHEET 1

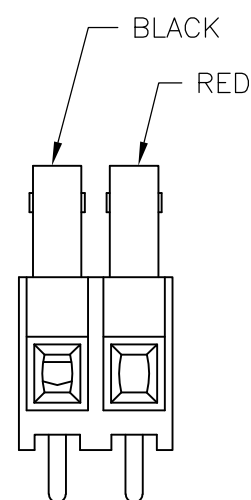

1437671-2

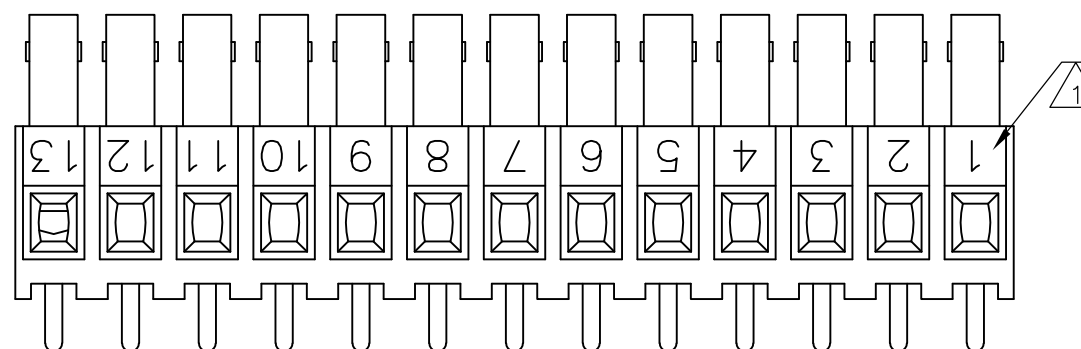

1-1437671-7

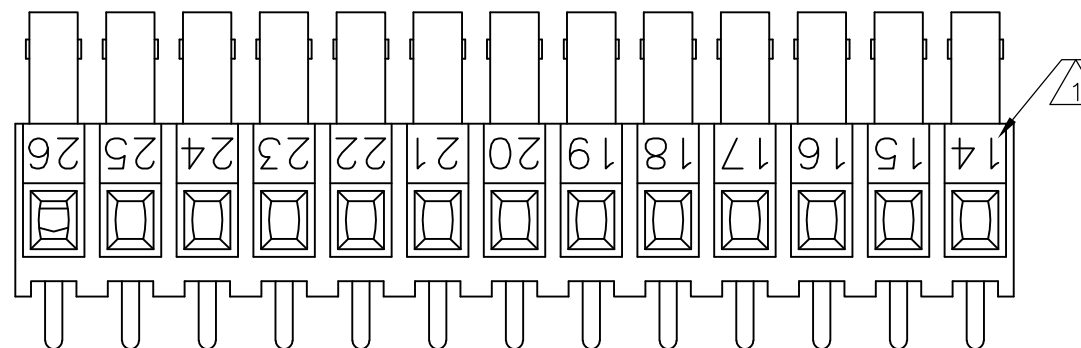

1-1437671-8

THIS DRAWING IS A CONTROLLED DOCUMENT.

DWN S SCHLEGEL 14JUN02



Tyco Electronics Corporation
Harrisburg, PA 17105-3608

DIMENSIONS:
INCHES

TOLERANCES UNLESS
OTHERWISE SPECIFIED:

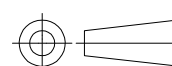

- 0 PLC ± -
- 1 PLC ± -
- 2 PLC ± .01
- 3 PLC ± .010
- 4 PLC ± -
- ANGLES ± -

CHK C RICHARD 1/22/03

APVD C RICHARD 1/22/03

NAME

2SV 5.08mm
SCREWLESS

PRODUCT SPEC

APPLICATION SPEC

SIZE

CAGE CODE

DRAWING NO

RESTRICTED TO

MATERIAL

FINISH

WEIGHT

A3

00779

C-1437671-1

-

CUSTOMER DRAWING

SCALE NTS

SHEET 2 OF 2

REV D2