

LOC		DIST		REVISIONS			
P	LTR	DESCRIPTION	DATE	OWN	APVD		
AD	00	AA1	REVISED PER ECO-11-005140	26MAR11	RK	HMR	

THIS DRAWING IS UNPUBLISHED. RELEASED FOR PUBLICATION. ALL RIGHTS RESERVED.

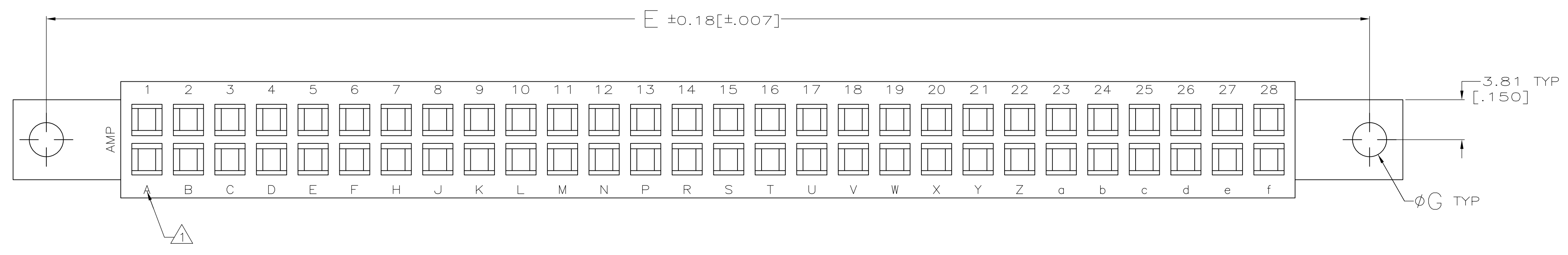

THIS DRAWING IS A CONTROLLED DOCUMENT.		OWN: J. GALLUCCI BG CHK: H. ROSE APVD: H. ROSE DATE: 3/2/94		NAME: H. ROSE	
DIMENSIONS: MM(INCHES)		TOLERANCES, UNLESS OTHERWISE SPECIFIED:		PRODUCT SPEC	
0 PLC ± -		1 PLC ± -		APPLICATION SPEC	
2 PLC ± -		3 PLC ± 0.13 [.005]		WEIGHT	
4 PLC ± -		ANGLES ± -		SIZE: A1	
MATERIAL: GLASS FILLED POLYESTER COLOR: BLACK		FINISH: -		CAGE CODE: 00779	
CUSTOMER DRAWING		SCALE: 4:1		SHEET 1 OF 2	

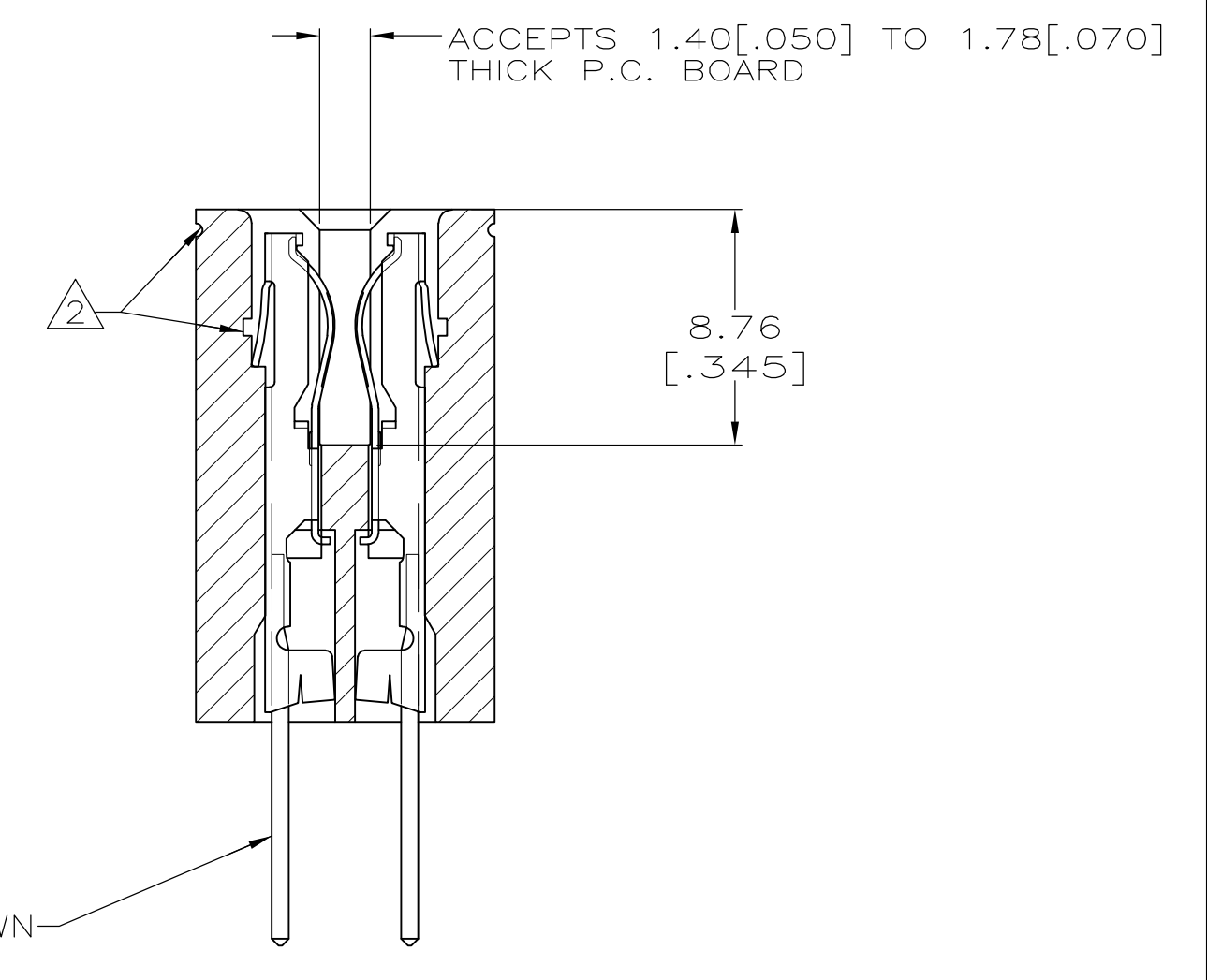
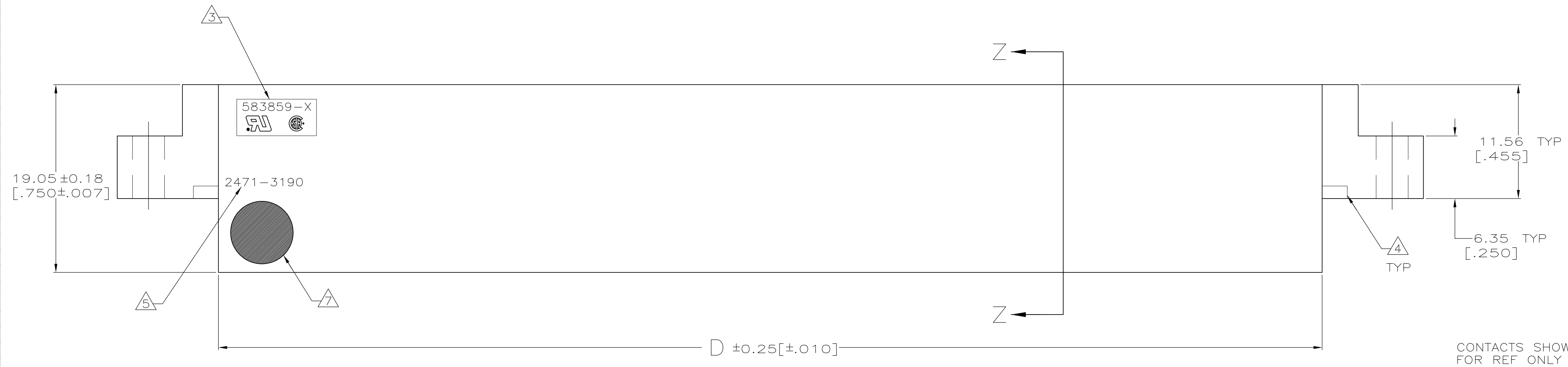
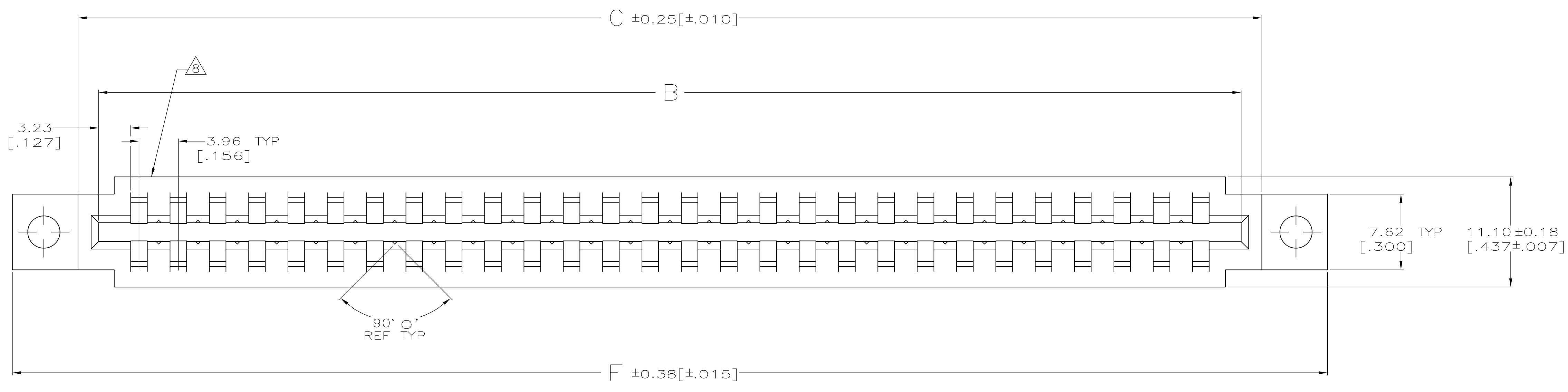

HOUSING, CRIMP SNAP
TWIN LEAF, .156¢
WITH MOUNTING EARS

SIZE: A1
CAGE CODE: 00779
DRAWING NO: 583859

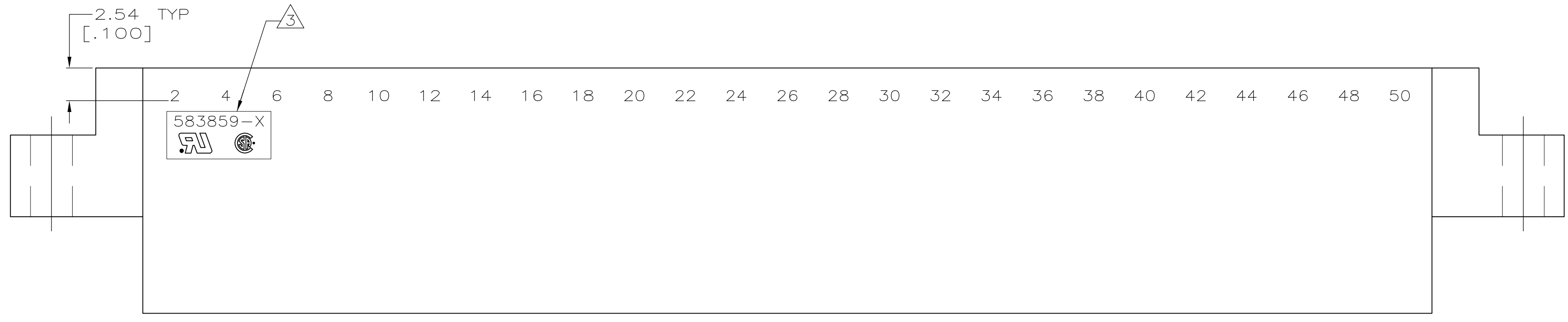

- ① FIRST 22 POSITIONS MARKED WITH UPPER CASE LETTERS, FOLLOWED BY LOWER CASE LETTERS, FOLLOWED BY UPPERCASE AA,AB,AC ETC. CHARACTERS G,I,O AND Q ARE OMITTED. SEE TABLE FOR END CAVITY IDENTIFICATION.
- ② PULL GROOVES OPTIONAL THESE LOCATIONS REF ONLY.
- ③ HOUSING PART NUMBER, UL & CSA LOGO'S TO BE MOLDED IN THIS AREA. UL LOGO PER 1-18838-3, CSA LOGO PER 1-18839-3.
- ④ CORING AT AMP'S OPTION REF ONLY.
- ⑤ HOT STAMP CUSTOMER PART NUMBER 2471-3190 IN THIS AREA FOR 1-583859-7 ONLY.
- ⑥ STAMPED WITH SPECIAL CAVITY IDENTIFICATION ON SIDES OF HOUSING.
- ⑦ $\phi 6.35 \pm 0.38 [.250 \pm 0.015]$ WHITE DOT IN LOWER LEFT HAND CORNER.
- ⑧ DATE CODE TO BE MOLDED IN THIS AREA

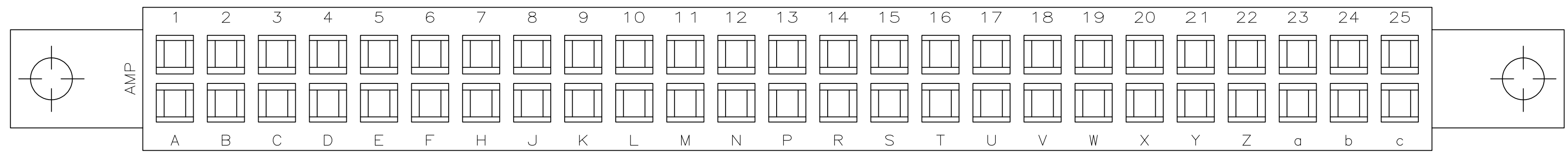

OBSOLETE	①	10 & L	.128	2.409	2.159	1.600	1.888	1.724	10	2-583859-8	
OBSOLETE		14 & R	.128	3.033	2.783	2.224	2.512	2.348	14	2-583859-7	
OBSOLETE	②	25 & c	.128	4.749	4.500	3.940	4.228	4.064	25	2-583859-5	
		36 & r	.128	6.465	6.215	5.656	5.944	5.780	36	2-583859-3	
		8 & J	.128	2.097	1.847	1.288	1.576	1.412	8	2-583859-1	
OBSOLETE		24 & b	.128	4.593	4.343	3.784	4.072	3.908	24	1-583859-9	
OBSOLETE	③	28 & f	.128	5.217	4.967	4.408	4.696	4.532	28	1-583859-7	
		12 & N	.128	2.721	2.471	1.912	2.200	2.036	12	1-583859-5	
		6 & F	.128	1.785	1.535	.976	1.264	1.100	6	1-583859-3	
OBSOLETE		18 & V	.156	3.657	3.407	2.848	3.136	2.972	18	1-583859-1	
		10 & L	.128	2.409	2.159	1.600	1.888	1.724	10	583859-9	
		15 & S	.128	3.189	2.939	2.380	2.668	2.504	15	583859-7	
		18 & V	.128	3.657	3.407	2.848	3.136	2.972	18	583859-5	
		22 & Z	.128	4.281	4.031	3.472	3.760	3.596	22	583859-3	
		28 & f	.128	5.217	4.967	4.408	4.696	4.532	28	583859-1	
		END CAVITY IDENT		G	F	E	D	C	B	POSN	PART NUMBER

2-583859-5 ④

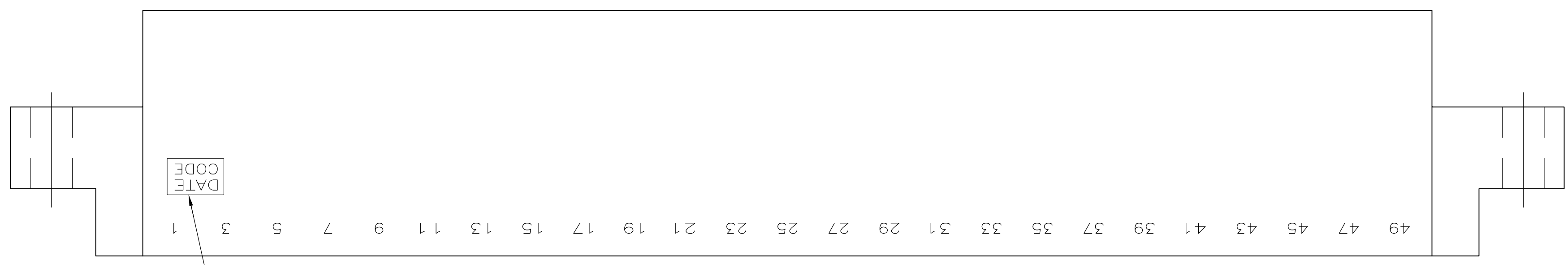

THIS DRAWING IS A CONTROLLED DOCUMENT.		OWN: J. GALLUCCI BC 12-10-92	PART NO	
DIMENSIONS: mm [INCHES]		CHK: H. ROSE 3/2/94	STE TE Connectivity	
TOLERANCES UNLESS OTHERWISE SPECIFIED:		APVD: H. ROSE 3/2/94	NAME: HOUSING, CRIMP SNAP TWIN LEAF, .156" WITH MOUNTING EARS	
0 PLC ± -		PRODUCT SPEC	SIZE: A1	
1 PLC ± -		APPLICATION SPEC	CAGE CODE: 00779	
2 PLC ± -		WEIGHT	DRAWING NO: 583859	
3 PLC ± -		FINISH	SCALE: 4:1	
4 PLC ± -			SHEET 2 OF 2	
ANGLES ± -			REV AA1	
MATERIAL: -		CUSTOMER DRAWING		