

MINIMUM INSERTION LOSS IN dB LINE TO GROUND IN 50 OHM CIRCUIT								MINIMUM INSERTION LOSS IN dB LINE TO LINE IN 50 OHM CIRCUIT							
CURRENT RATING		FREQUENCY MHz						CURRENT RATING		FREQUENCY MHz					
0.15	0.5	1	3	5	10	30	0.15	0.5	1	3	5	10	30		
H MODELS								H MODELS							
3 AMP	21	27	30	29	26	23	15	3 AMP	4	12	18	31	40	48	41
6 AMP	11	15	17	19	18	16	13	6 AMP	4	12	16	26	35	40	35
10 AMP	5	8	10	12	11	11	10	10 AMP	4	12	16	26	33	40	32
S MODELS								S MODELS							
3 AMP	21	27	33	40	44	50	32	3 AMP	4	12	15	30	48	50	45
6 AMP	12	17	23	32	36	44	30	6 AMP	4	12	15	22	42	55	45
10 AMP	5	10	13	23	27	35	27	10 AMP	4	12	15	22	42	55	45

STYLE	DIMENSION 'A'		DIMENSION B
	UNSHIELDED	SHIELDED	
PS	1.06	1.12	2.201 *
PSL	1.12		2.201 *
PE	1.12	1.12	2.201 *
PM	1.06	1.12	2.13
PSC	1.06	1.12	2.52
PSJ	1.06	1.12	2.6

* FOR PANEL THICKNESS OF 0.031"-0.079" ONLY.
USE 2.213 FOR PANEL THICKNESS OF 0.083"-0.114"

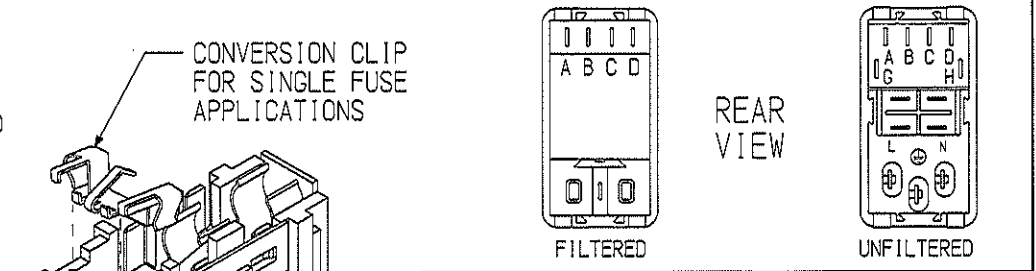
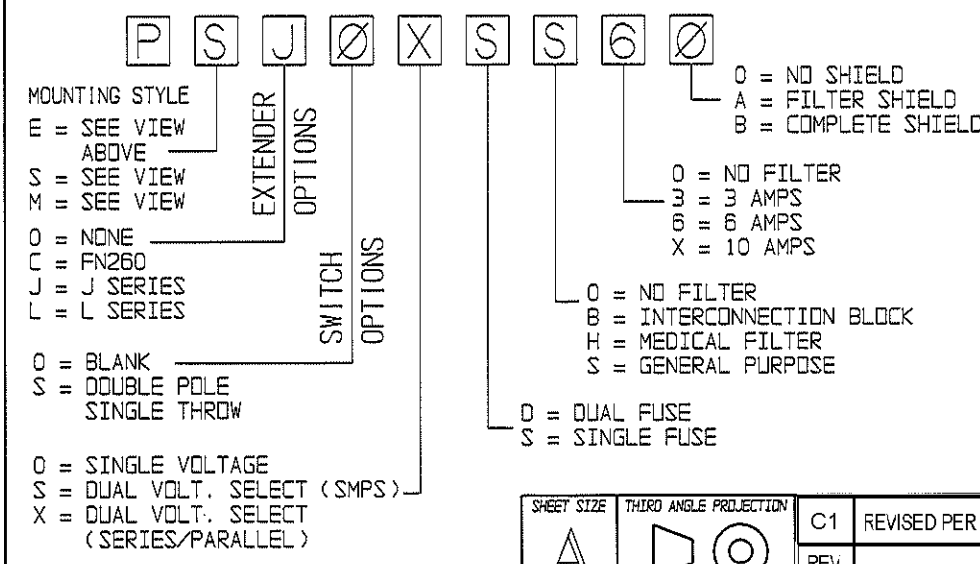
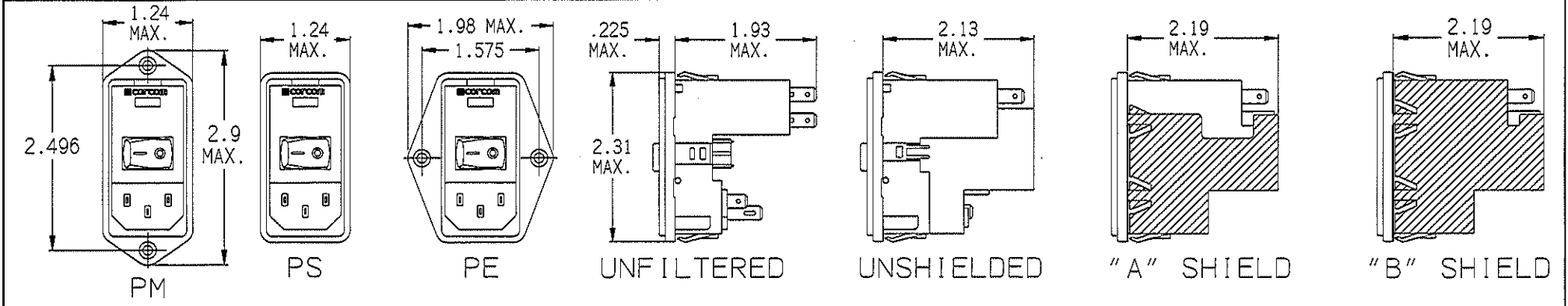
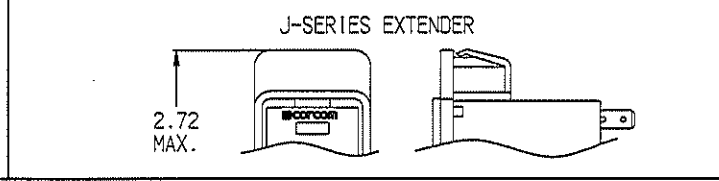
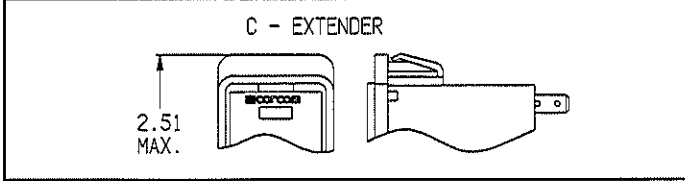
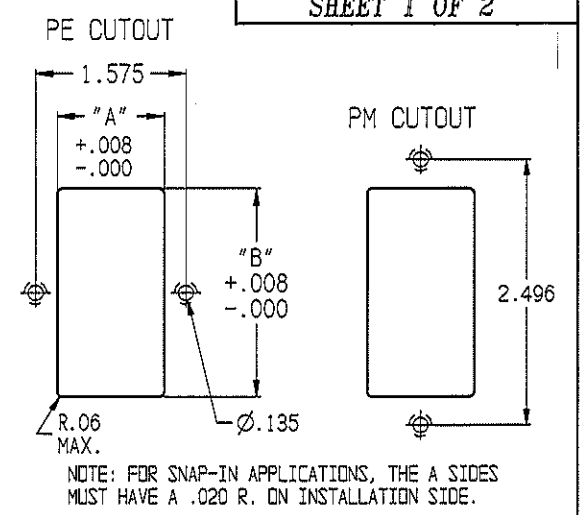

STE TE Connectivity

CUSTOMER DRAWING
P-SERIES

TE CONNECTIVITY PART NO.

SCALE: 1:2	DATE: 2-4-97	DRAWING NUMBER: P-SERIES	REV. C1
DRW. BY:	DRIG:		

SHEET SIZE	THIRD ANGLE PROJECTION	C1	REVISED PER ECO-11-005139	28MAR11	RK	HMR
A		REV	ECO	DATE	DWN	APR

SPECIFICATIONS

HIPOT RATING (ONE MINUTE)

LINE TO GROUND:	1500 VAC
LINE TO LINE:	1450 VDC
OPERATING FREQUENCY:	50/60 Hz
RATED VOLTAGE:	120/250 VAC
OPERATING VOLTAGES:	115/230 VAC
SELECTABLE OR FIXED:	SELECTABLE FUSEHOLDER ACCEPTS 1 OR 2 FUSES 1/4" x 1-1/4" OR 5 x 20mm

OPERATING AMBIENT TEMP.: -10°C TO +40°C

STORAGE TEMPERATURE: -40°C TO +85°C

HUMIDITY: 21 DAYS, 40°C @95% RH.

CURRENT OVERLOAD TEST: 6 TIMES I_R FOR 8 SECONDS

NONFILTERED MODELS

RATED CURRENT; I _R :	10A @ 120 VAC
	10A @ 250 VAC

FILTERED MODELS

MAXIMUM LEAKAGE CURRENT, EACH LINE TO GROUND

@ 120 VAC 60Hz:	H MODELS 2µA
	S MODELS 0.25m
@ 250 VAC 50Hz:	H MODELS 5µA
	S MODELS 0.50mA

RATED CURRENT; I_R: 3, 6 & 10 AMP MODELS AVAILABLE

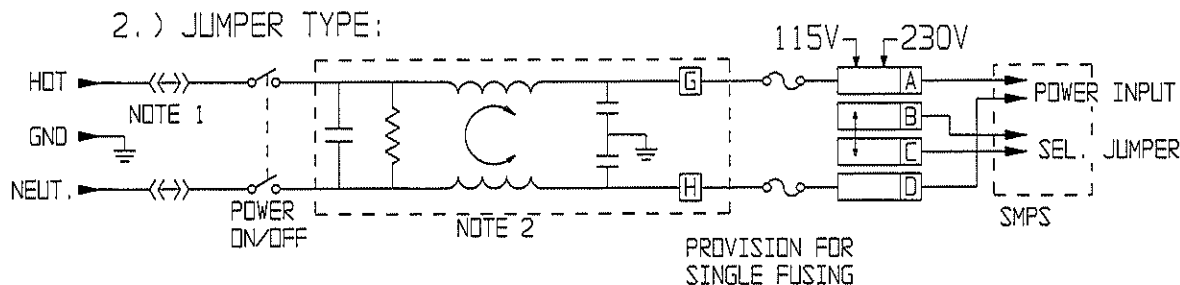
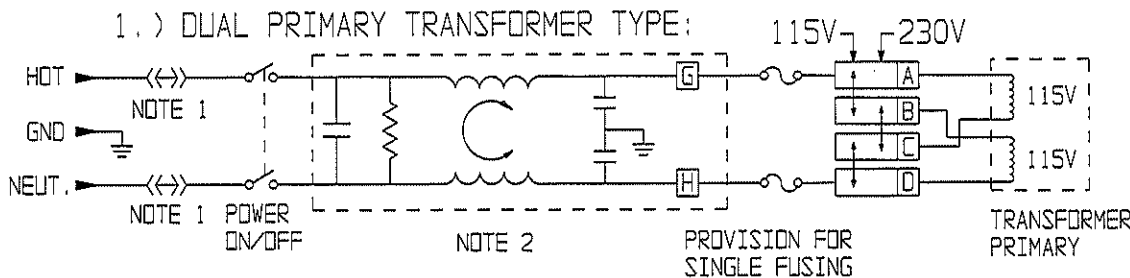

NOTE 1: JUMPERS ARE REQUIRED IF A FILTER OR INTERCONNECTION MODULE IS NOT USED.

NOTE 2: LOCATION OF OPTIONAL FILTER. JUMPERS ARE REQUIRED IF A FILTER OR INTERCONNECTION MODULE IS NOT USED.

GENERAL NOTES:

CONVERSION CLIP PROVIDED ON FUSEHOLDER FOR SINGLE FUSE MODELS.

SWITCH: DOUBLE INSULATED RATED FOR 10,000 OPERATIONS AT FULL LOAD.

51 AMP INRUSH CAPABILITY.

TERMINALS: 0.187" x 0.032" FASTON TABS

SAFETY ORGANIZATIONS

THIS FILTER HAS BEEN FORMALLY RECOGNIZED, CERTIFIED OR APPROVED BY THE LISTED AGENCY. THEREFORE, ALL TEST/REQUIREMENTS SPECIFIED IN THE LATEST REVISION OF THE FOLLOWING AGENCY STANDARDS HAVE BEEN MET:

UL RECOGNIZED
CSA CERTIFIED
VDE APPROVED

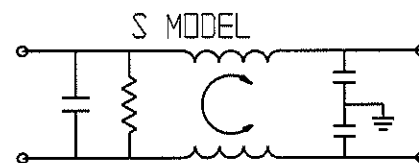
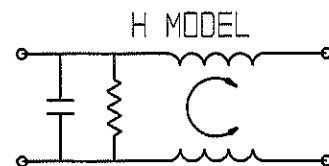

SEE INDIVIDUAL CUSTOMER DRAWINGS FOR OTHER (L AND Z) P-SERIES VERSIONS.

TE TE Connectivity			
CUSTOMER DRAWING P-SERIES			
TE CONNECTIVITY PART NO.			
SCALE: NA	DATE: 2/4/97	DRAWING NUMBER:	REV.
DRW. BY:	ORIG:	P-SERIES	C1

SHEET SIZE	THIRD ANGLE PROJECTION	SEE SHEET 1						
A	▶ ◯	REV	ECO	DATE	DWN	APR		