

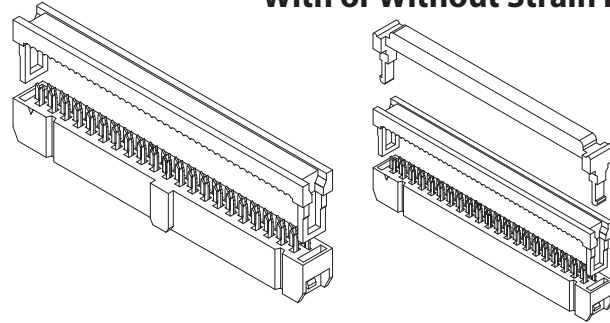

.100" [2.54 mm] IDC Socket, Insulation Displacement With or Without Strain Relief

- **Centered Polarizing Key Optional**
- Operating Temperature: - 40° C to + 105° C
- UL Flammability Rating: 94V-0
- Current Rating: 1 AMP per contact
- Dielectric Withstanding: 500 VAC
- Insulation Resistance: 3,000 Mega OHMS
- For 1.27 mm Pitch AWG 28 Flat Ribbon Cable
- **Mates with SBH11 series**



PART NUMBER OPTIONS

SFH210 - P P P C - D 10 - ID - BK - Mxxx

SERIES

SFH210 = IDC Socket, Without Strain Relief,
.100" [2.54mm] Contact Centers

SFH213 = IDC Socket, With Strain Relief,
.100" [2.54mm] Contact Centers

HOUSING MATERIAL

P = PBT

CONTACT MATERIAL

P = Phosphor Bronze

CONTACT FINISH - RoHS Compliant

P = Gold Flash Overall

E = .000100" Pure Tin, Matte, Overall

V = Gold Flash on Contact Surface, Nickel Underplate on Tails

J = .000015" Gold on Contact Surface, Gold Flash on Tails

K = .000015" Gold on Contact Surface, Nickel Underplate on Tails

MODIFICATION (Omit for Standard)

M181 = Without Centered Polarizing Key

M207 = With Polarizing Key, With Mylar in Tape & Reel (only for SFH210)

M208 = Without Polarizing Key, With Mylar in Tape and Reel (only for SFH210)

COLOR

BK = Black

TERMINATION TYPE

ID = Insulation Displacement

NUMBER OF CONTACT POSITIONS

03 thru 13, 15, 17, 20, 25, 30, 32

*M208 and M207 not available in 30 and 32

NUMBER OF ROWS

D = Dual Row

CONTACT CENTERS

C = .100" [2.54mm]

Sullins Headers

DIMENSIONS For complete drawings, go to www.sullinscorp.com or e-mail techsupport@sullinscorp.com

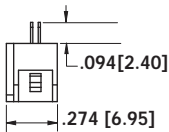
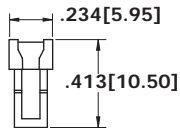

INSULATION DISPLACEMENT (ID)
without Strain Relief
requires SFH210

Example P/N: SFH210-PPPC-D03-ID-BK

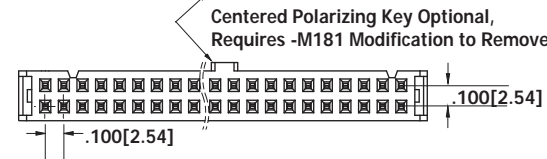
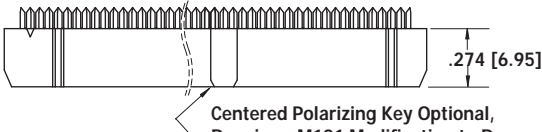
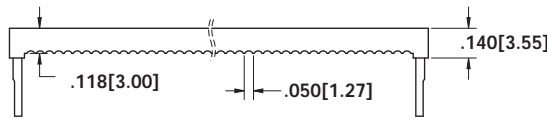

Centered Polarizing Key Optional,
Requires -M181 Modification to Remove

-M181 Modification
(No Centered
Polarizing Key)

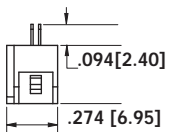
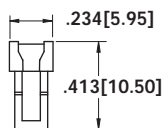
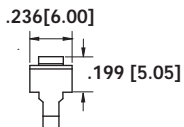
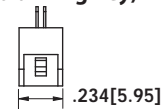

INSULATION DISPLACEMENT (ID)
with Strain Relief
requires SFH213

Example P/N: SFH213-PPPC-D03-ID-BK

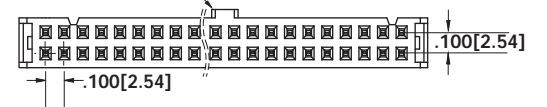
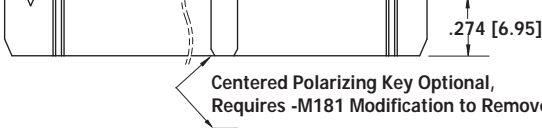
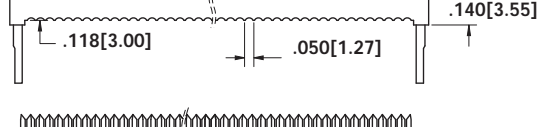
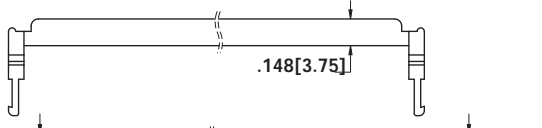

Centered Polarizing Key Optional,
Requires -M181 Modification to Remove

-M181 Modification
(No Centered
Polarizing Key)

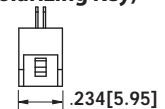



.100" [2.54 mm] IDC Dip Plug, Straight

SPECIFICATIONS

- Operating Temperature: - 40° C to + 105° C
- Current Rating: 1 AMP per contact
- Dielectric Withstanding: 1,000 VAC
- Insulation Resistance: 5,000 Mega OHMS
- For 1.27 mm Pitch AWG 28 Flat Ribbon Cable

PART NUMBER OPTIONS

SIP110 - P P P C - D 10 - ST - BK

SERIES _____
SIP110 = IDC Dip Plug
.100" [2.54mm] Contact Centers

HOUSING MATERIAL _____
P = PBT

CONTACT MATERIAL _____
P = Phosphor Bronze

CONTACT FINISH - RoHS Compliant _____
P = Gold Flash Overall
E = .000100" Pure Tin, Matte, Overall
V = Gold Flash on Contact Surface, Nickel Underplate on Tails
J = .000015" Gold on Contact Surface, Gold Flash on Tails
K = .000015" Gold on Contact Surface, Nickel Underplate on Tails

COLOR _____
BK = Black

TERMINATION TYPE _____
ST = Straight
SK = Straight with Kink

NUMBER OF CONTACT POSITIONS _____
03 thru 10, 12, 13, 14, 15, 17, 20, 25, 30, 32

NUMBER OF ROWS _____
D = Dual Row

CONTACT CENTERS _____
C = .100" [2.54mm]

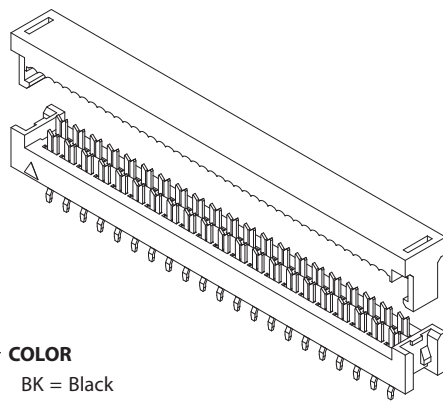

DIMENSIONS For complete drawings, go to www.sullinscorp.com or e-mail techsupport@sullinscorp.com

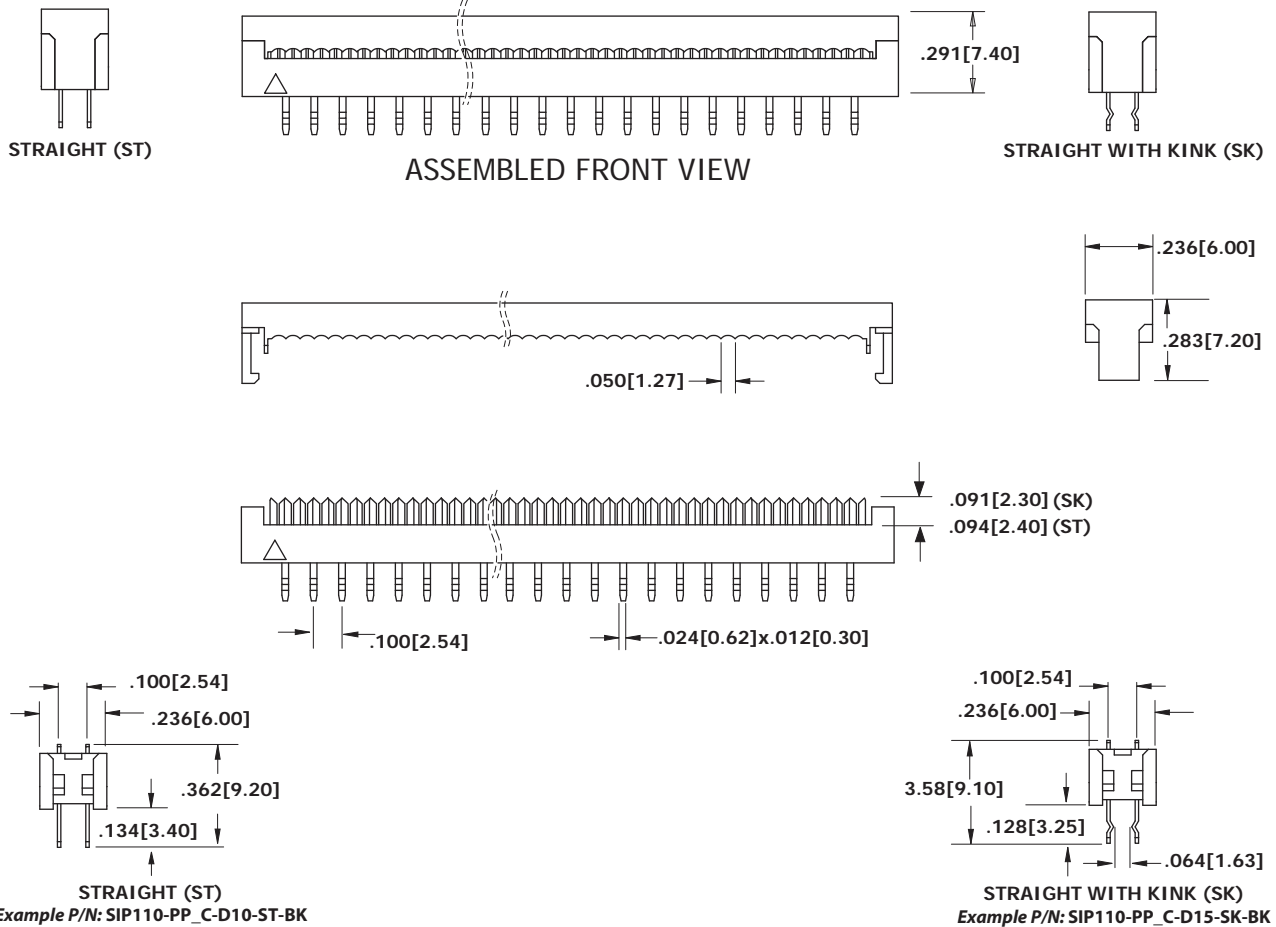

Sullins Headers