



Pb-free  
HEAT

**STANLEY**

# 5614X Series

Bi-color  $\phi$  5 Round Shape Type

## Features

Package	Bi-color $\phi$ 5 Round shape type, Milky White Diffused epoxy
Product features	<ul style="list-style-type: none"><li>• Outer Dimension <math>\phi</math> 5 Round shape type</li><li>• Operation temperature range. Storage Temperature : -30°C~100°C Operating Temperature : -30°C~85°C</li><li>• Lead-free soldering compatible</li><li>• RoHS compliant</li></ul>
Dominant wavelength	Green : 558nm (BG) : 567nm (PG) Yellow Green : 572nm (PY) Red : 624nm (VR)
Half Intensity Angle	BG,PG,PY : 31 deg. VR : 30 deg.
Die materials	BG,PG,PY : GaP VR : GaAsP
Rank grouping parameter	Sorted by luminous intensity per rank taping
Soldering methods	TTW (Through The Wave) soldering and manual soldering
ESD	More than 2kV(HBM)
Packing	Bulk : 200pcs(MIN.)

## Recommended Applications

Amusement Equipment, Electric Household Appliances, OA/FA, Other General Applications

## Color and Luminous Intensity

(Ta=25°C)

Part No.	Die Name	Material	Emitted Color	Lens Color	Lens Color	Dominant Wavelength		Luminous Intensity		
						$\lambda d$ (nm)		Iv (mcd)		
						TYP.	I <sub>F</sub>	MIN.	TYP.	I <sub>F</sub>
VRBG5614X	BG	GaP	Green	Milky White	Diffused	558	20	8	16	20
	VR	GaAsP	Red			624	20	15	30	20
VRPG5614X	PG	GaP	Green	Milky White	Diffused	567	20	15	30	20
	VR	GaAsP	Red			624	20	15	30	20
VRPY5614X	PY	GaP	Yellow Green	Milky White	Diffused	572	20	25	50	20
	VR	GaAsP	Red			624	20	15	30	20

## Absolute Maximum Ratings

(Ta=25°C)

Item	Symbol	Absolute Maximum Ratings				Unit
		BG	PG	PY	VR	
Power Dissipation	$P_d$	75	75	75	75	mW
Forward Current	$I_F$	30	30	30	30	mA
Pulse Forward Current ※1	$I_{FRM}$	100	100	100	100	mA
Derating (Ta=25°C or higher)	$\Delta I_F$	0.33	0.33	0.33	0.33	mA/°C
Reverse Voltage	$V_R$	4	4	4	4	V
Operating Temperature	$T_{opr}$	-30~+85				°C
Storage Temperature	$T_{stg}$	-30~+100				°C

 ※1  $I_{FRM}$  Measurement condition : Pulse Width  $\leq 1$ ms., Duty  $\leq 1/20$ .

 ※ The ratings specified above are under the condition that only one diode is lit.  
 50% Max. of each rating shall be applied when two diodes are lit simultaneously.

## Electro-Optical Characteristics

(Ta=25°C)

Item	Conditions	Symbol	Characteristics				Unit	
			BG	PG	PY	VR		
Forward Voltage	I <sub>F</sub> =20mA	V <sub>F</sub>	TYP.	2.1	2.1	2.1	2.0	V
			MAX.	2.5	2.5	2.5	2.5	
Reverse Current	V <sub>R</sub> =4V	I <sub>R</sub>	MAX.	100	100	100	100	$\mu$ A
Peak Wavelength	I <sub>F</sub> =20mA	$\lambda_p$	TYP.	555	560	570	630	nm
Dominant Wavelength	I <sub>F</sub> =20mA	$\lambda_d$	TYP.	558	567	572	624	nm
Spectral Line Half Width	I <sub>F</sub> =20mA	$\Delta \lambda$	TYP.	30	30	30	30	nm
Half Intensity Angle	I <sub>F</sub> =20mA	2 $\theta$ 1/2	TYP.	31	31	31	30	deg.

## Luminous Intensity Rank

( $T_a=25^\circ\text{C}$ )

Rank	$I_v$ (mcd)												Condition
	VRBG5614X				VRPG5614X				VRPY5614X				
	BG		VR		PG		VR		PY		VR		
	MIN.	MAX.	MIN.	MAX.	MIN.	MAX.	MIN.	MAX.	MIN.	MAX.	MIN.	MAX.	
AA	8.0	22.4	15.0	42.0	15	42	15	42	25	70	15	42	$I_F = 20\text{mA}$
AB	16.0	44.8	15.0	42.0	30	84	15	42	50	140	15	42	
BA	8.0	22.4	30.0	84.0	15	42	30	84	25	70	30	84	
BB	16.0	44.8	30.0	84.0	30	84	30	84	50	140	30	84	

Please contact our sales staff concerning rank designation.

## Technical Data(VRBG)

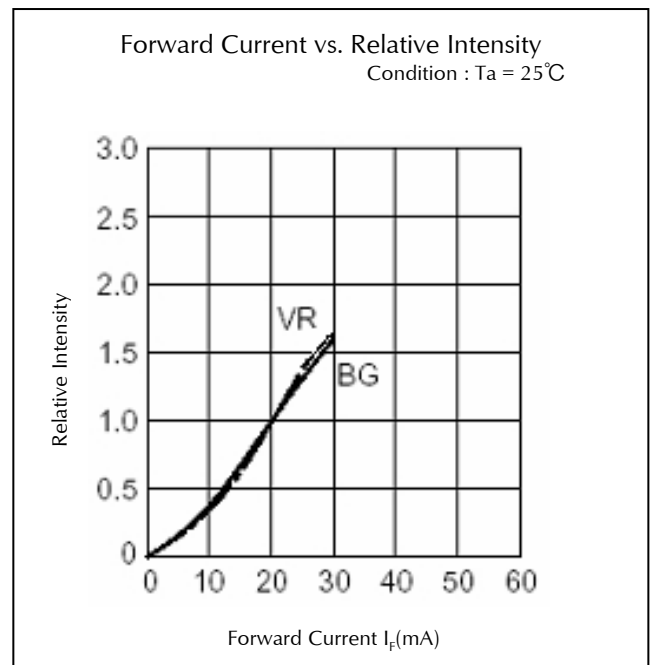
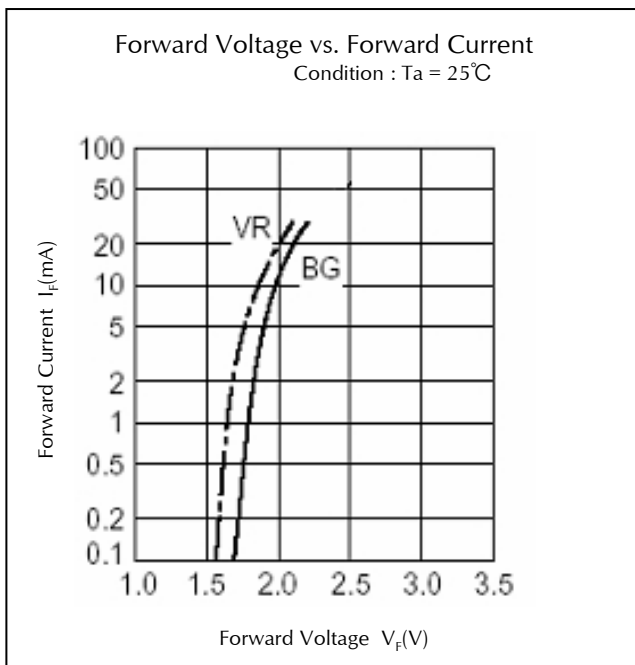
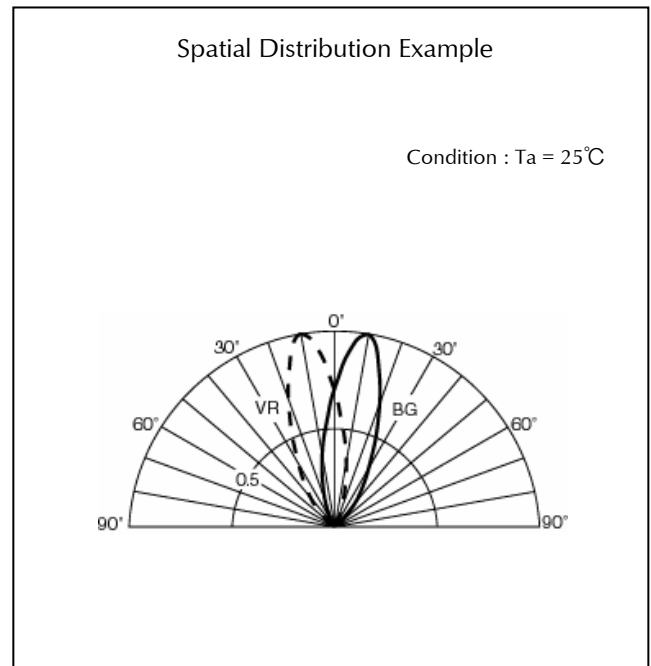
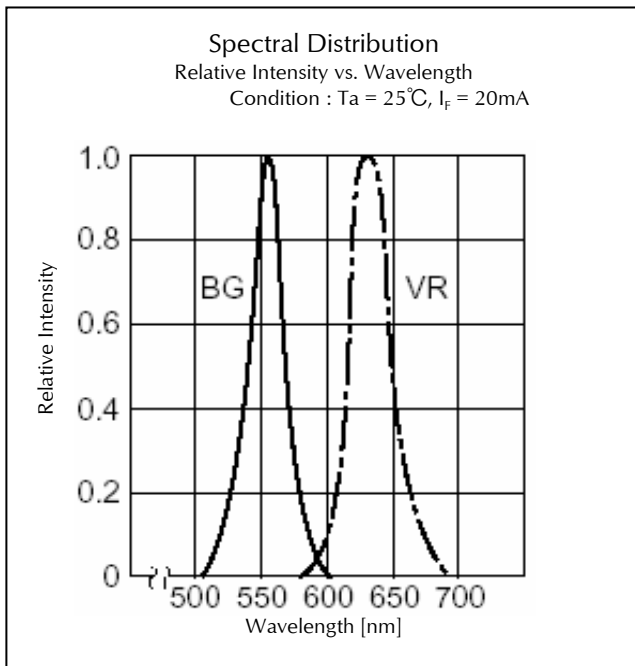

## Technical Data(VRBG)

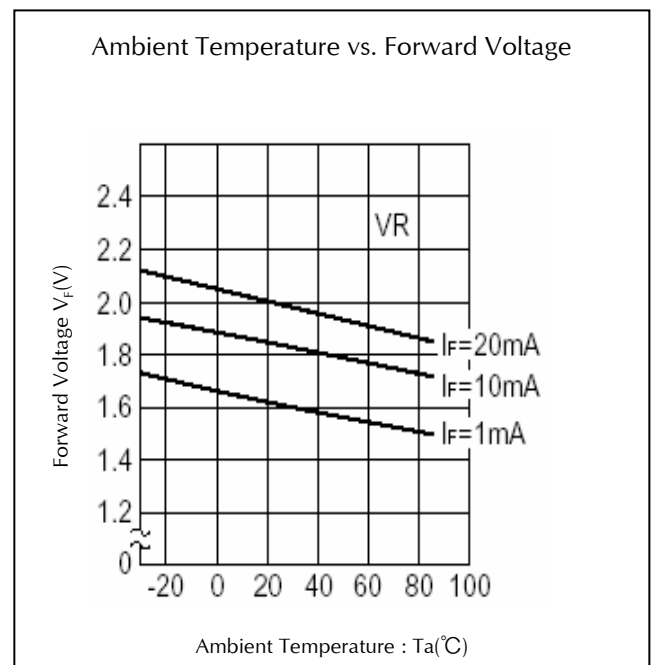
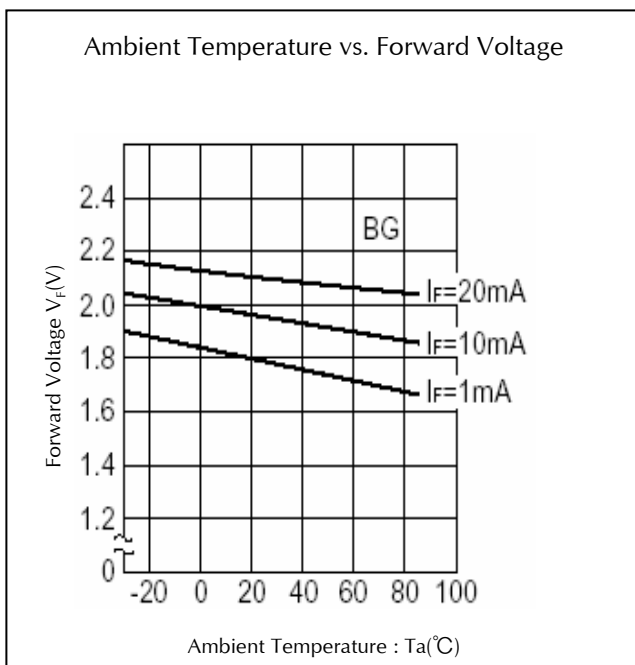
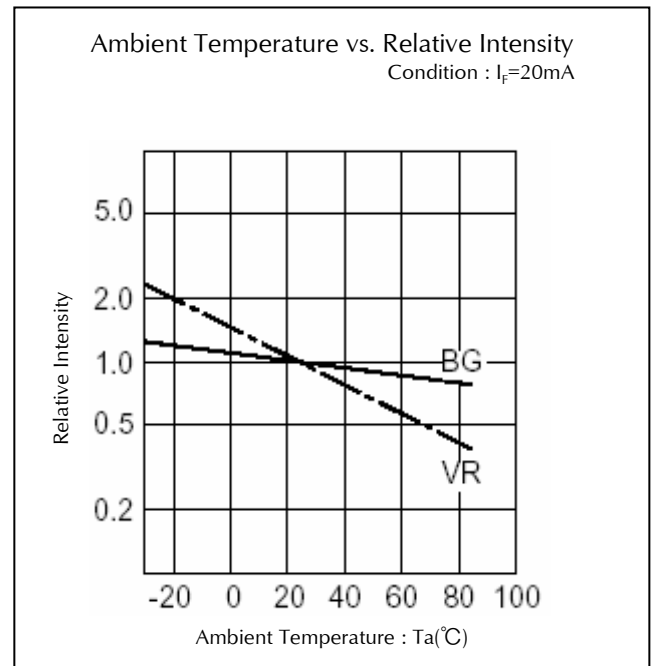
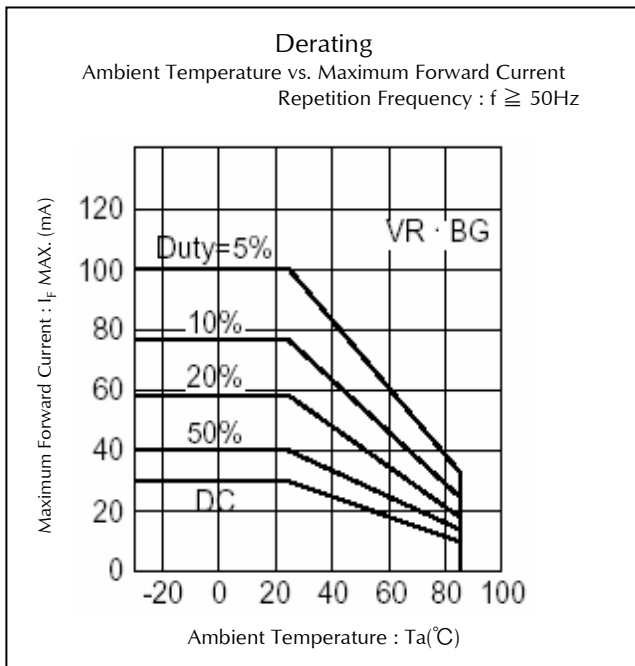

## Technical Data(VRBG)

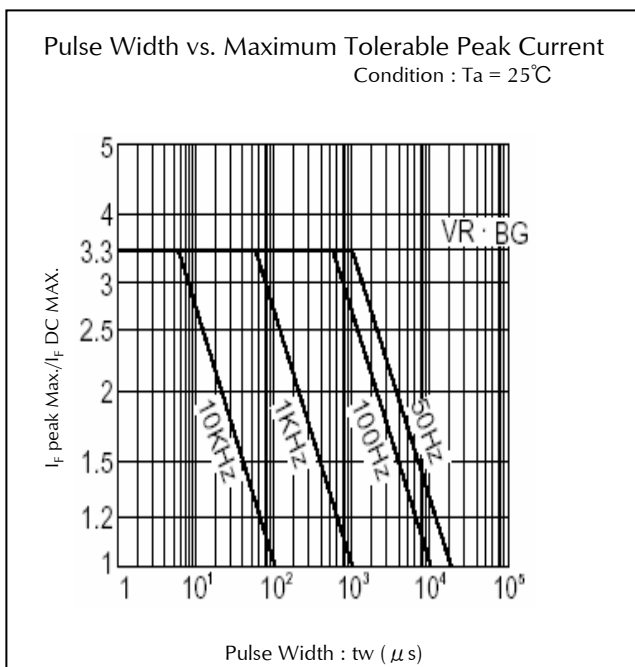
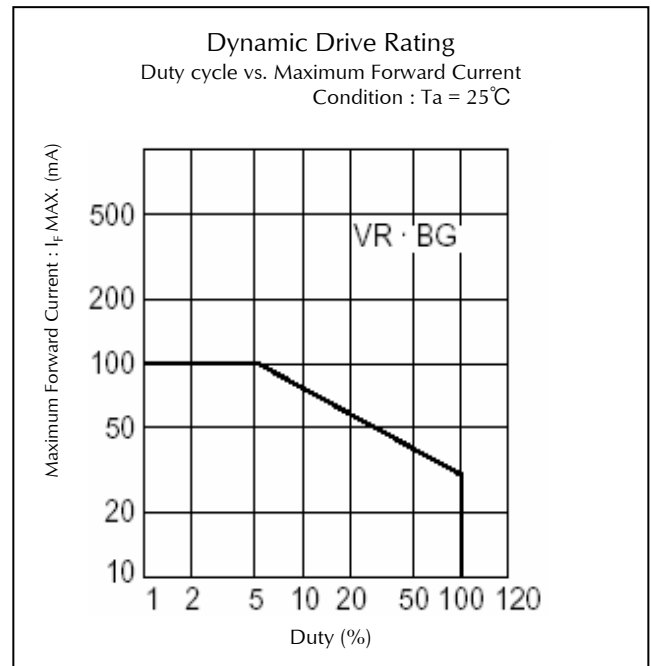
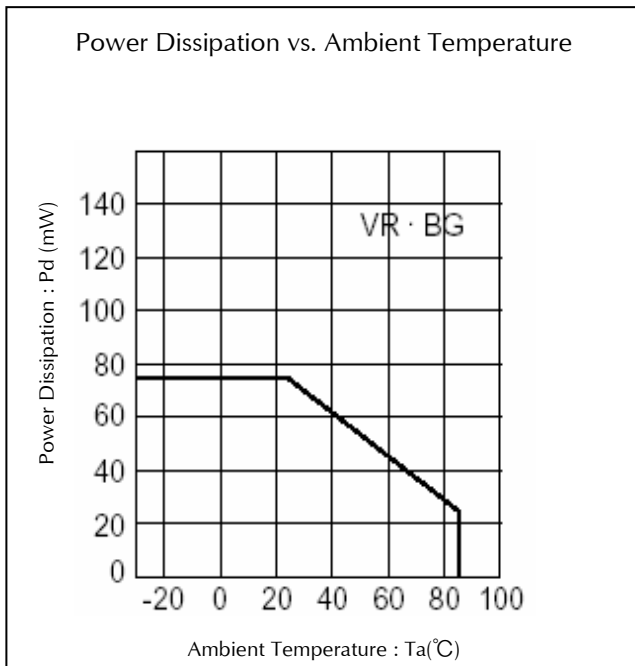



## Technical Data(VRPG)

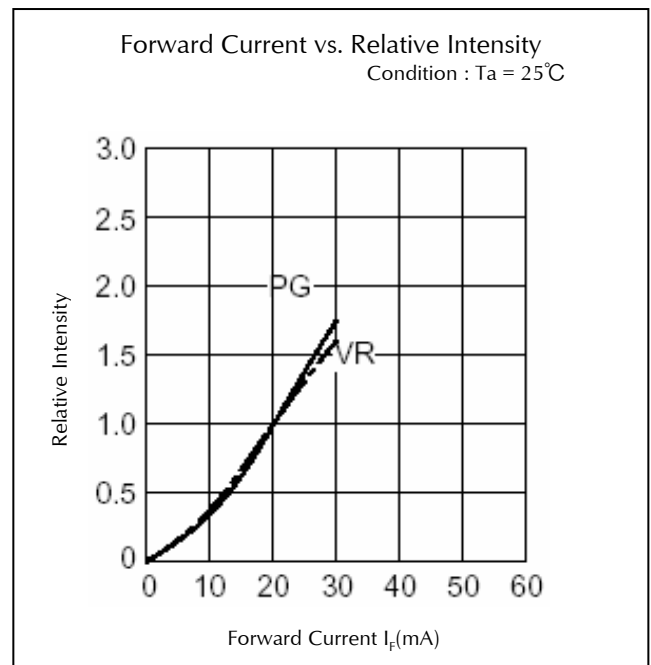
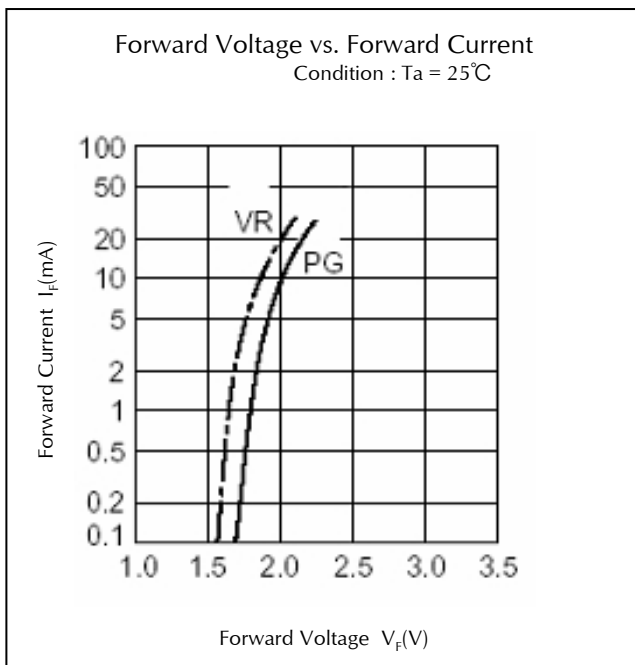
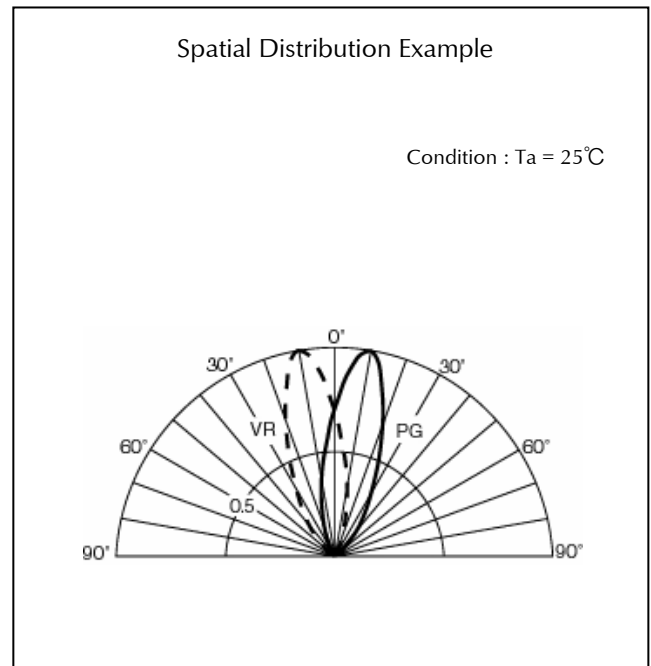
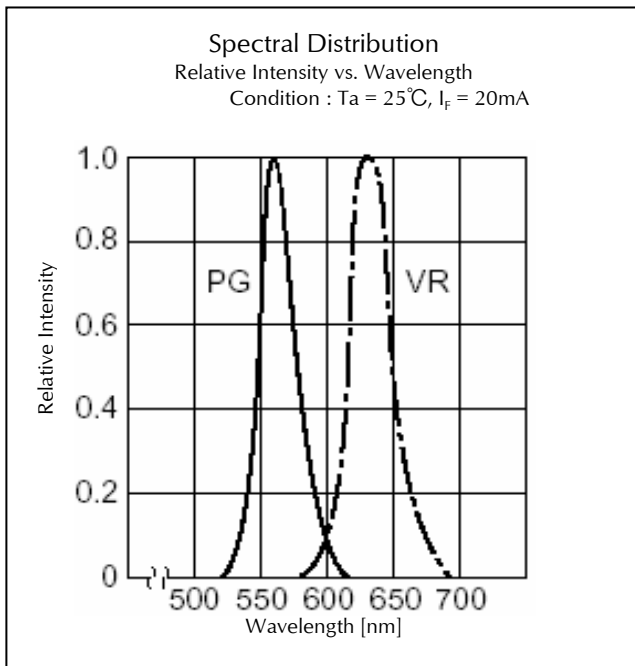

## Technical Data(VRPG)

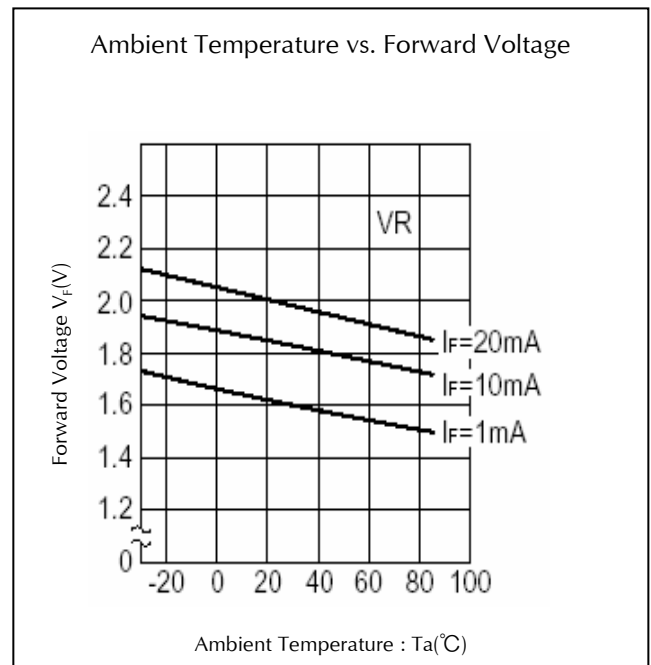
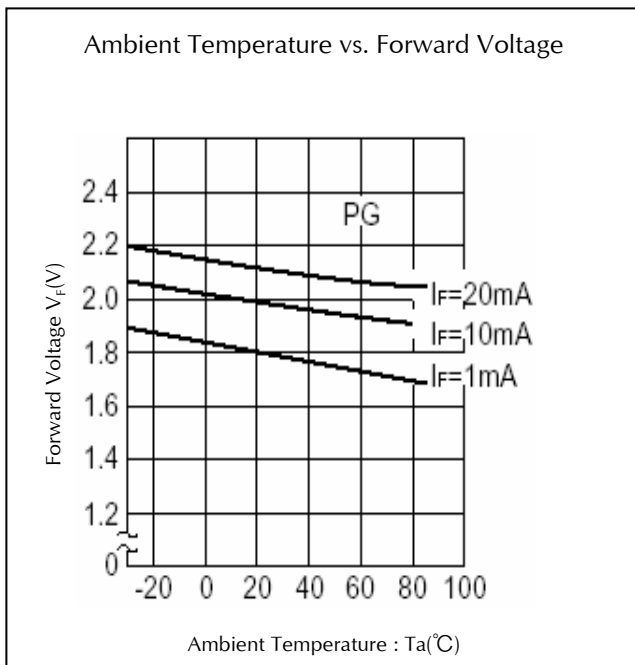
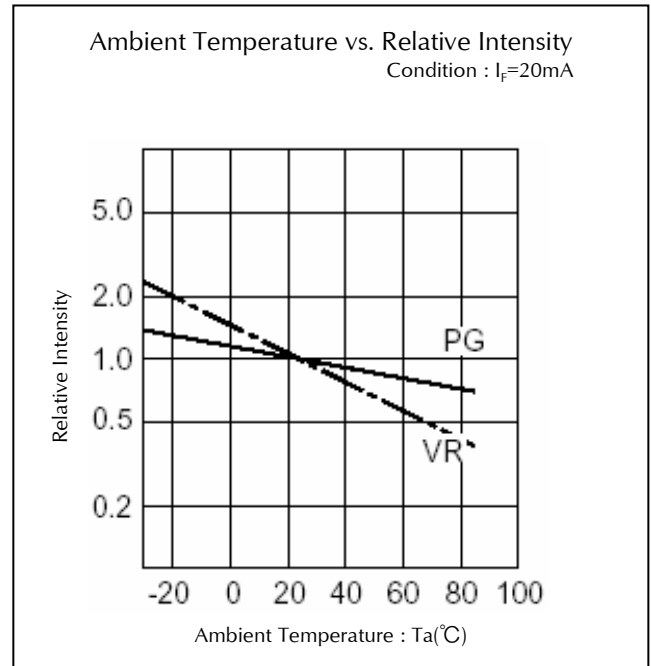
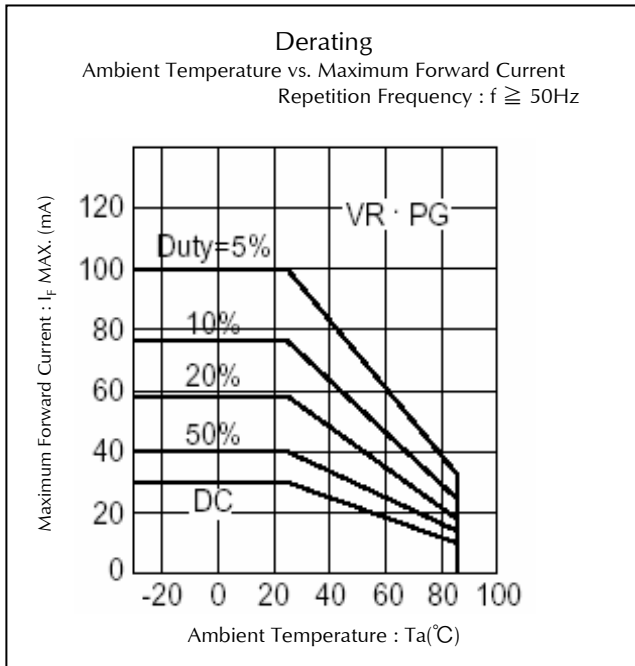

## Technical Data(VRPG)

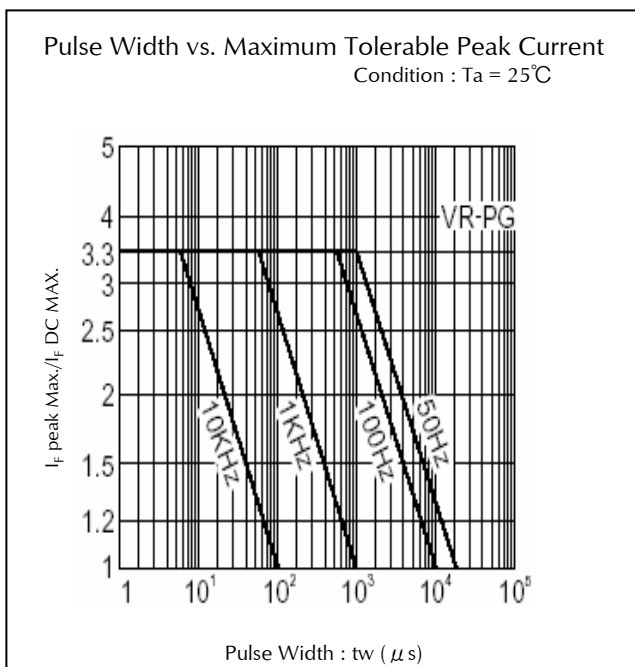
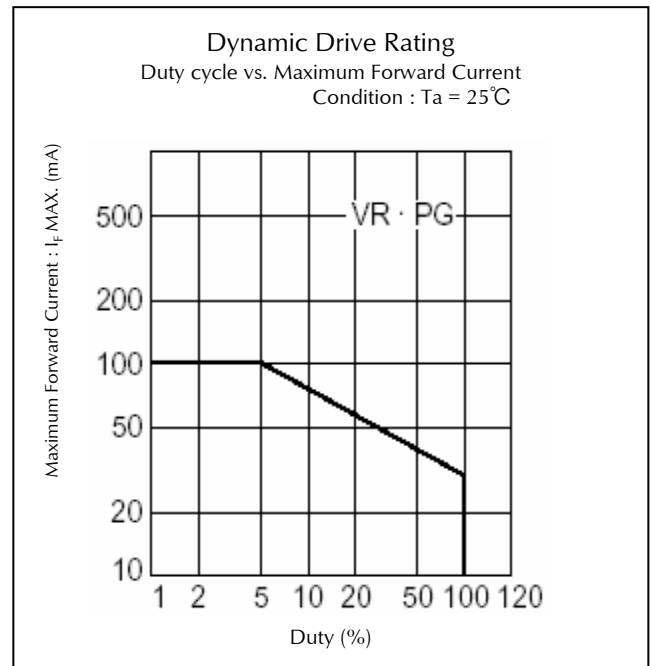
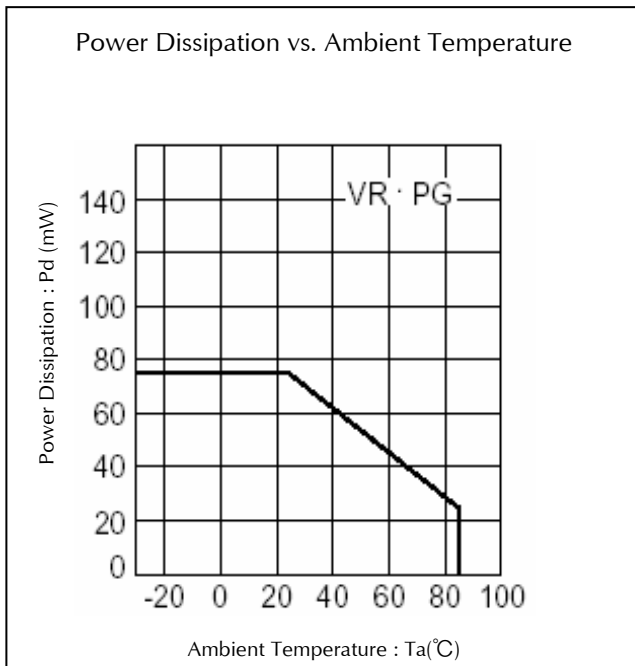

## Technical Data(VRPY)

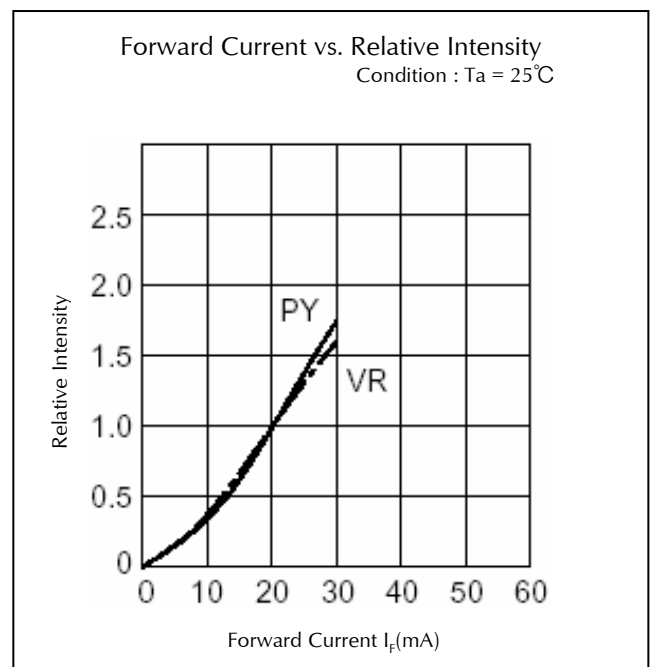
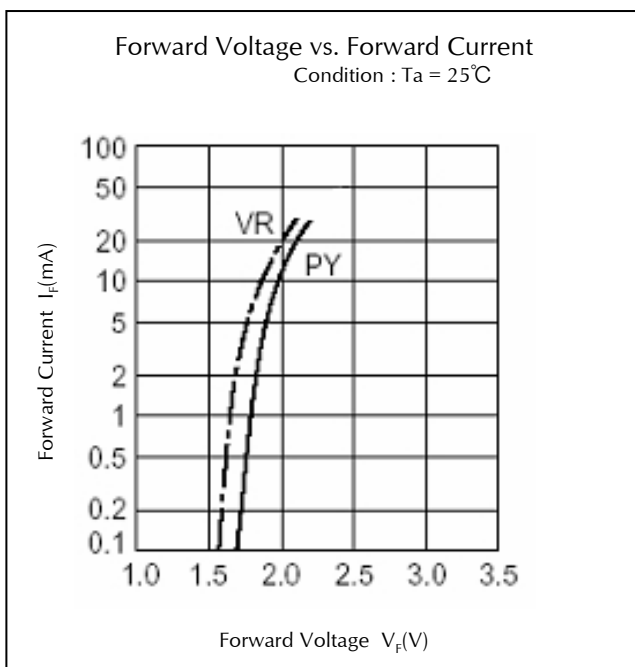
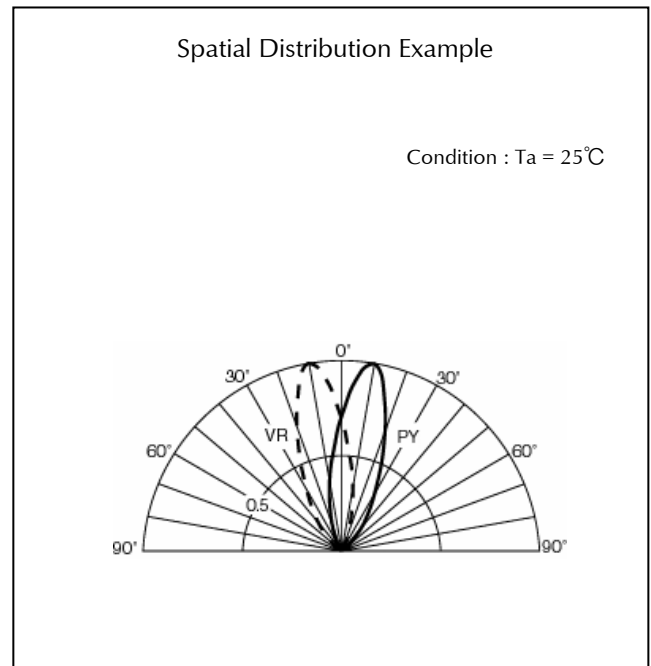
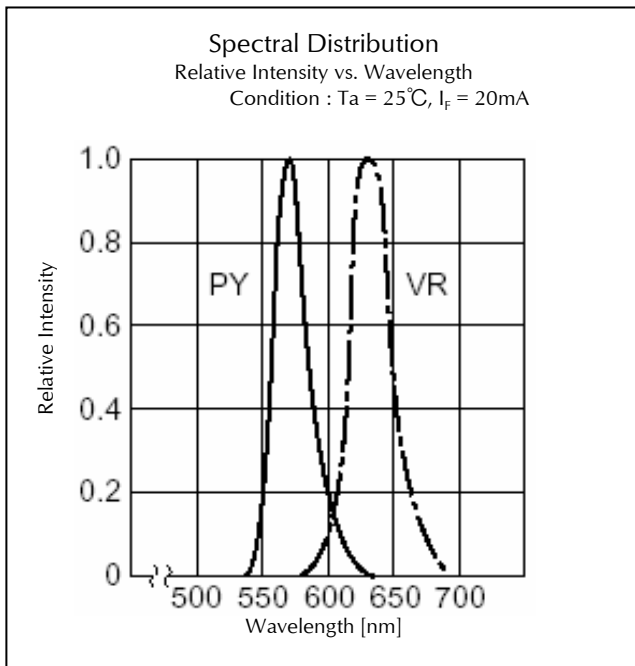

## Technical Data(VRPY)

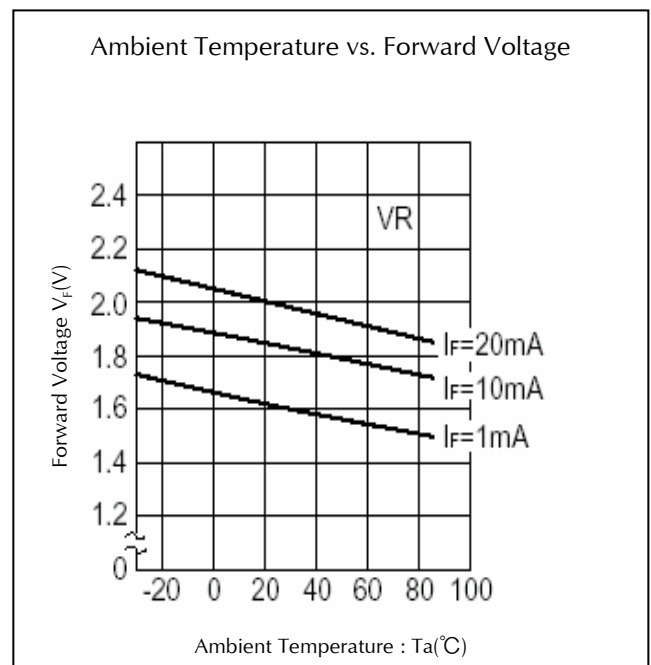
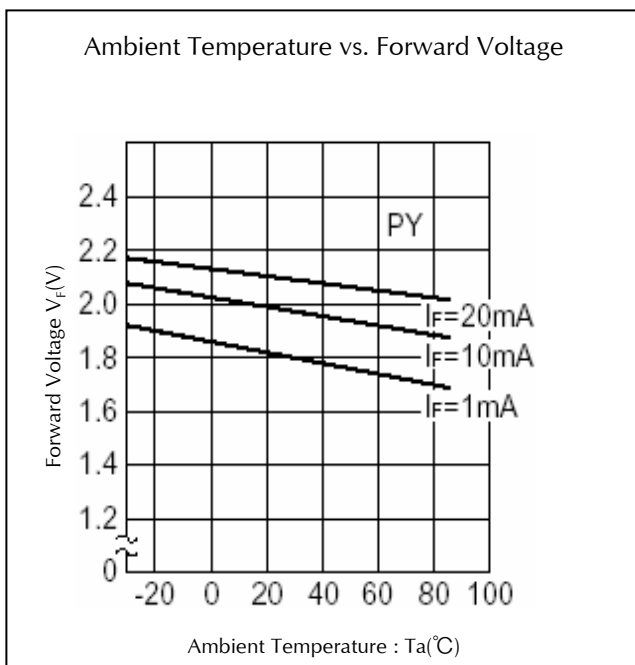
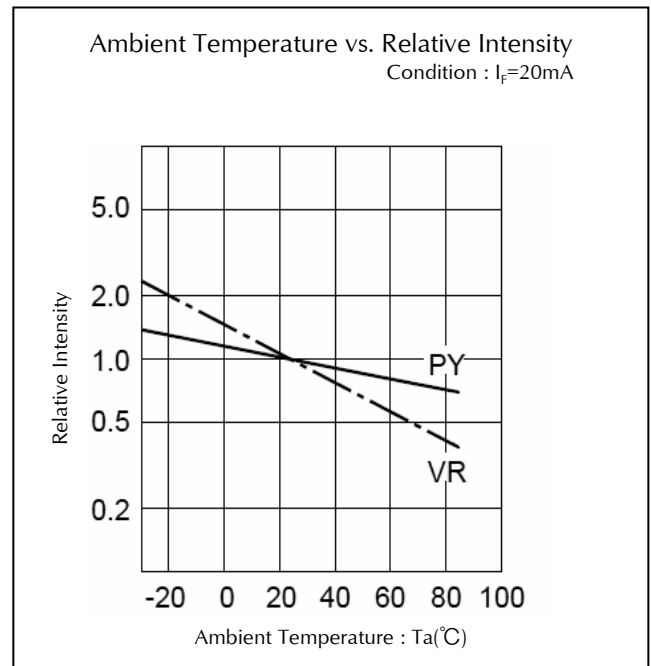
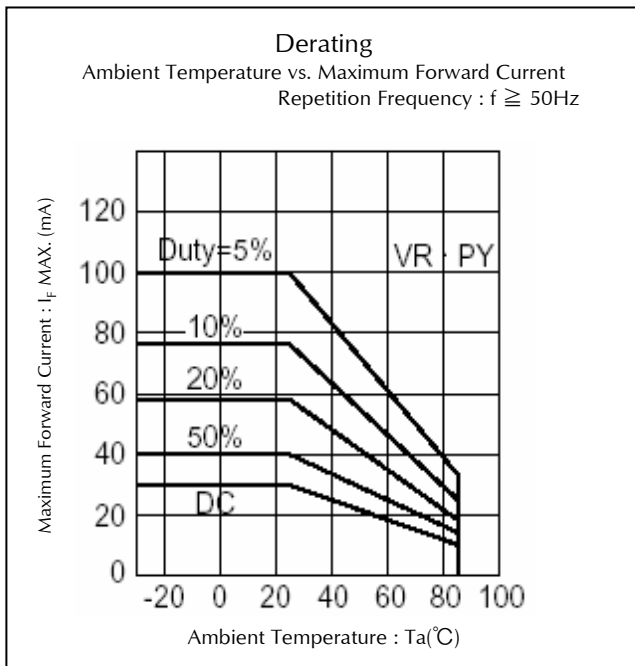

## Technical Data(VRPY)

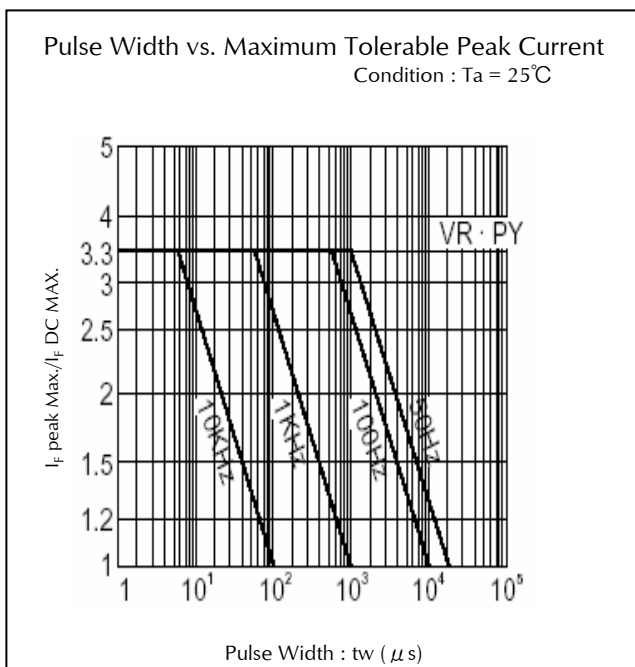
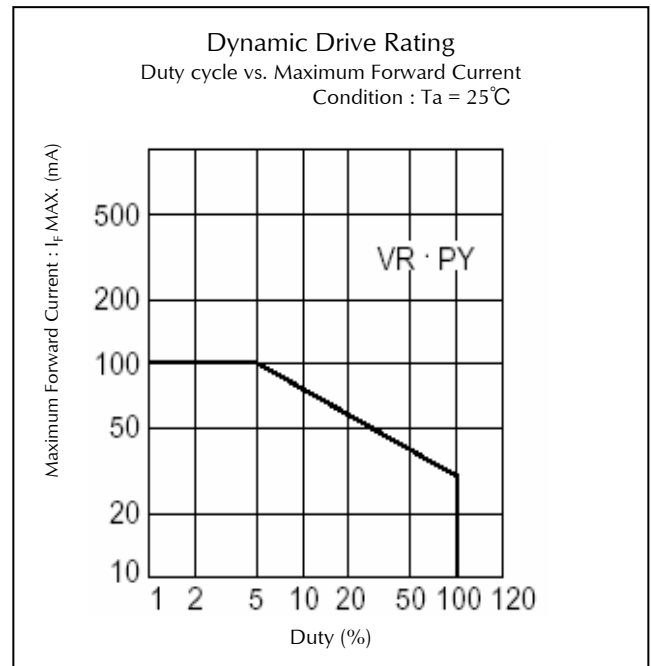
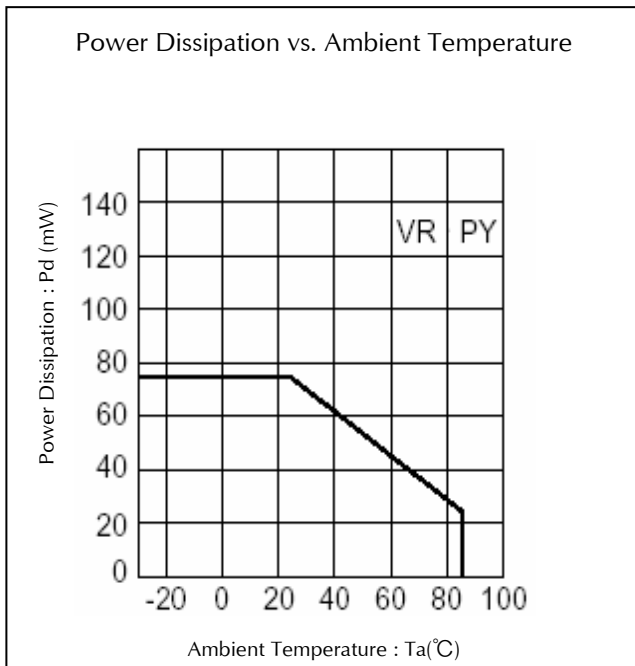

Package Dimensions

(Unit: mm)

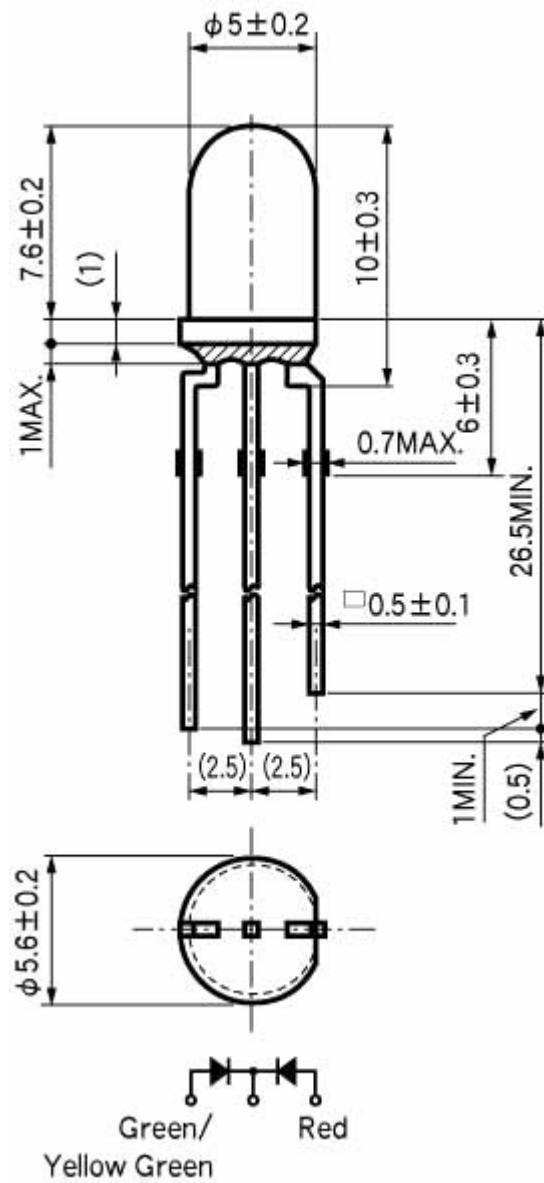

## TTW (Through The Wave) soldering Conditions

---

Pre-heating	100 °C	(MAX.)
Solder Bath Temp.	265°C	(MAX.)
Dipping Time	5 s	(MAX.)

- 1) The dip soldering process shall be 2 times maximum.
- 2) The product shall be cooled to room temp. before the second dipping process.

※The detail is described to LED and Photodetector handling precautions of home page:  
 "Mounting through-hole Type Devices" and "Soldering", and use it after the confirmation, please.

## Manual Soldering Conditions

---

Iron tip temp.	400°C	(MAX.)
Soldering time and frequency	3 s	(MAX.)
	2 times	(MAX.)

※The detail is described to LED and Photodetector handling precautions of home page:  
 "Mounting through-hole Type Devices" and "Soldering", and use it after the confirmation, please.



## Reliability Testing Result

Reliability Testing Result	Applicable Standard	Testing Conditions	Duration	Failure
Room Temp. Operating Life	EIAJ ED-4701/100(101)	Ta = 25°C, If = Maximum Rated Current	1,000 h	0/25
Resistance to Soldering Heat	EIAJ ED-4701/300(302)	260±5°C, 3mm from package base	10s	0/25
Temperature Cycling	EIAJ ED-4701/100(105)	Minimum Rated Storage Temperature(30min) ~Normal Temperature(15min) ~Maximum Rated Storage Temperature(30min) ~Normal Temperature(15min)	5 cycles	0/25
Wet High Temp. Storage Life	EIAJ ED-4701/100(103)	Ta = 60±2°C, RH = 90±5%	1,000 h	0/25
High Temp. Storage Life	EIAJ ED-4701/200(201)	Ta = Maximum Rated Storage Temperature	1,000 h	0/25
Low Temp. Storage Life	EIAJ ED-4701/200(202)	Ta = Minimum Rated Storage Temperature	1,000 h	0/25
Lead Tension	EIAJ ED-4701/400(401)	10N, 1time (□0.4 and Flat Package : 5N)	10s	0/10
Vibration, Variable Frequency	EIAJ ED-4701/400(403)	98.1m/s <sup>2</sup> (10G), 100 ~ 2KHz sweep for 20min., XYZ each direction	2 h	0/10

## Failure Criteria

Items	Symbols	Conditions	Failure criteria
Luminous Intensity	Iv	If Value of each product Luminous Intensity	Testing Min. Value < Spec. Min. Value x 0.5
Forward Voltage	V <sub>F</sub>	If Value of each product Forward Voltage	Testing Max. Value ≥ Spec. Max. Value x 1.2
Reverse Current	I <sub>R</sub>	V <sub>R</sub> = Maximum Rated Reverse Voltage V	Testing Max. Value ≥ Spec. Max. Value x 2.5
Cosmetic Appearance	-	-	Occurrence of notable decoloration, deformation and cracking

## Special Notice to Customers Using the Products and Technical Information Shown in This Data Sheet

- 1) The technical information shown in the data sheets are limited to the typical characteristics and circuit examples of the referenced products. It does not constitute the warranting of industrial property nor the granting of any license.
- 2) For the purpose of product improvement, the specifications, characteristics and technical data described in the data sheets are subject to change without prior notice. Therefore it is recommended that the most updated specifications be used in your design.
- 3) When using the products described in the data sheets, please adhere to the maximum ratings for operating voltage, heat dissipation characteristics, and other precautions for use. We are not responsible for any damage which may occur if these specifications are exceeded.
- 4) The products that have been described to this catalog are manufactured so that they will be used for the electrical instrument of the benchmark (OA equipment, telecommunications equipment, AV machine, home appliance and measuring instrument).  
The application of aircrafts, space borne application, transportation equipment, medical equipment and nuclear power control equipment, etc. needs a high reliability and safety, and the breakdown and the wrong operation might influence the life or the human body. Please consult us beforehand if you plan to use our product for the usages of aircrafts, space borne application, transportation equipment, medical equipment and nuclear power control equipment, etc. except OA equipment, telecommunications equipment, AV machine, home appliance and measuring instrument.
- 5) In order to export the products or technologies described in this data sheet which are under the "Foreign Exchange and Foreign Trade Control Law," it is necessary to first obtain an export permit from the Japanese government.
- 6) No part of this data sheet may be reprinted or reproduced without prior written permission from Stanley Electric Co., Ltd.
- 7) The most updated edition of this data sheet can be obtained from the address below:  
<http://www.stanley-components.com>