



**Pb-free
HEAT**



□W1145L□ Series

Right Angle Type White LED

Features

Package	Right Angle Type, Diffused pale yellow resin
Product features	<ul style="list-style-type: none"> • Outer Dimension 3.8 x 1.2 x 0.6mm (L x W x H) • Temperature range Storage Temperature : -40°C~100°C Operating Temperature : -30°C~85°C • Lead-free soldering compatible • RoHS compliant
Chromaticity coordinates	x = 0.299YP., y = 0.296TYP. (Condition : I _F =20mA)
Spatial distribution	$\theta_x = 110 \text{ deg.}$, $\theta_y = 105 \text{ deg.}$
Die materials	InGaN
Rank grouping parameter	Sorted by luminous intensity and chromaticity per rank taping
Assembly method	Auto pick & place machine (Auto Mounter)
Soldering methods	Recommendation of Reflow soldering / Flow Soldering (Dip Soldering) is impossible.
Taping and reel	3,000pcs per reel in a 12mm width tape. (Standard) Reel diameter: ϕ 180mm
ESD	1kV (HBM)

Recommended Applications

Cellular Phone, Mobile Equipment, Electric Household Appliances, Other General Applications

Color and Luminous Intensity

(Ta=25°C)

Part No.	Material	Emitted Color	Lens Color	Luminous Intensity			Luminous Flux	
				I _v (mcd)			φ v (lm)	
				MIN.	TYP.	I _F	TYP.	I _F
HSW1145LT	InGaN	White	Pale Yellow	1,720	1,860	20	4.6	20
SW1145LT	InGaN	White	Pale Yellow	1,440	1,600	20	4.0	20
TW1145LS	InGaN	White	Pale Yellow	860	1,200	20	3.0	20

 ※Note : The above luminous intensity(I_v) is the setup values of the sorting machine.

 (Tolerance : I_v... ±10%)

Absolute Maximum Ratings

(Ta=25°C)

Item	Symbol	Absolute Maximum Ratings			Unit
		HSW	SW	TW	
Power Dissipation	P_d	114	114	117	mW
Forward Current	I_F	30	30	30	mA
Pulse Forward Current ※1	I_{FRM}	100	100	100	mA
Derating (Ta=25°C or higher)	ΔI_F	0.4	0.4	0.4	mA/°C
	ΔI_{FRM}	1.33	1.33	1.33	mA/°C
Reverse Voltage	V_R	5	5	5	V
Operating Temperature	T_{opr}	-30~+85			°C
Storage Temperature	T_{stg}	-40~+100			°C

 ※1 I_{FRM} Measurement condition : Pulse Width ≤ 1 ms, Duty $\leq 1/20$

Electro-Optical Characteristics

(Ta=25°C)

Item	Condition	Symbol	Characteristics			Unit	
			HKW	TW	TW		
Forward Voltage※1	I _F =20mA	V _F	TYP.	3.2	3.2	3.2	V
			MAX.	3.5	3.5	3.7	
Reverse Current	V _R =5V	I _R	MAX.	50	50	50	μA
Half Intensity Angle	I _F =20mA	2θ 1/2	TYP.	110(θ x)	110(θ x)	110(θ x)	deg.
				105(θ y)	105(θ y)	105(θ y)	
Chromaticity Coordinates	I _F =20mA	x	TYP.	0.299	0.299	0.299	-
		y	TYP.	0.296	0.296	0.296	-

※1 Forward Voltage Tolerance Range : ±0.1V

Luminous Intensity Rank (HSW)

(Ta=25°C)

Intensity Tolerance each Rank : +/-10%

Rank	I _v (mcd)		Condition
	MIN.	MAX.	
VC	1,720	1,860	I _F =20mA
VD	1,860	2,000	
WA	2,000	2,200	
WB	2,200	2,400	

Please contact our sales staff concerning rank designation.

Luminous Intensity Rank (SW)

(Ta=25°C)

Intensity Tolerance each Rank : +/-10%

Rank	I _v (mcd)		Condition
	MIN.	MAX.	
VA	1,440	1,580	I _F =20mA
VB	1,580	1,720	
VC	1,720	1,860	
VD	1,860	2,000	

Please contact our sales staff concerning rank designation.

Luminous Intensity Rank (TW)

(Ta=25°C)

Intensity Tolerance each Rank : +/-10%

Rank	I _v (mcd)		Condition
	MIN.	MAX.	
T2	860	1,000	I _F =20mA
U1	1,000	1,200	
U2	1,200	1,440	

Please contact our sales staff concerning rank designation.

Sorting Chart for Chromaticity Coordinates (HSW/SW)

(Ta=25°C)

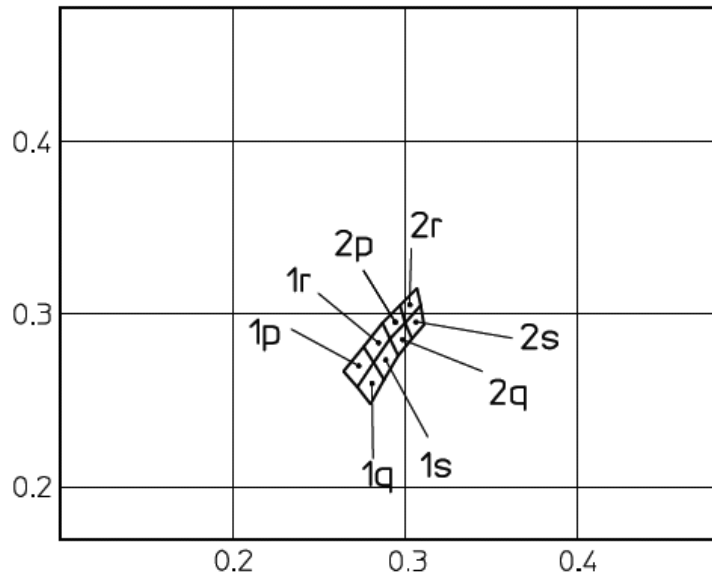
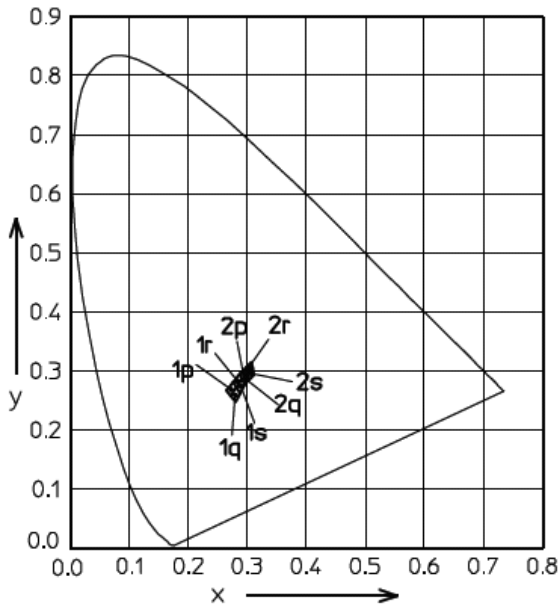

Chromaticity Coordinates Tolerance Each Rank : +/-0.01

Rank	LEFT DOWN point		LEFT UP point		RIGHT UP point		RIGHT UP point	
	x	y	x	y	x	y	x	y
1p	0.272	0.258	0.264	0.267	0.276	0.281	0.282	0.272
1q	0.280	0.248	0.272	0.258	0.282	0.272	0.288	0.262
1r	0.282	0.272	0.276	0.281	0.287	0.295	0.292	0.286
1s	0.288	0.262	0.282	0.272	0.292	0.286	0.296	0.276
2p	0.292	0.286	0.287	0.295	0.297	0.305	0.300	0.295
2q	0.296	0.276	0.292	0.286	0.300	0.295	0.304	0.285
2r	0.300	0.295	0.297	0.305	0.307	0.315	0.309	0.305
2s	0.304	0.285	0.300	0.295	0.309	0.305	0.311	0.294

Please contact our sales staff concerning rank designation.

Sorting Chart for Chromaticity Coordinates (TW)

(Ta=25°C)

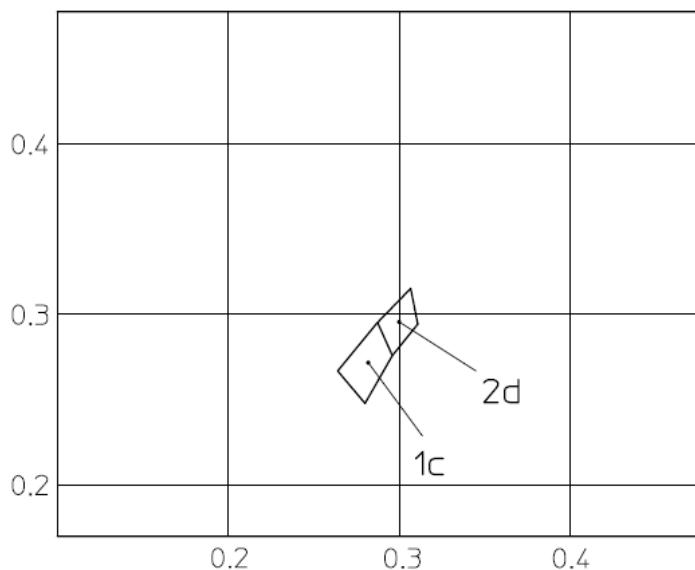
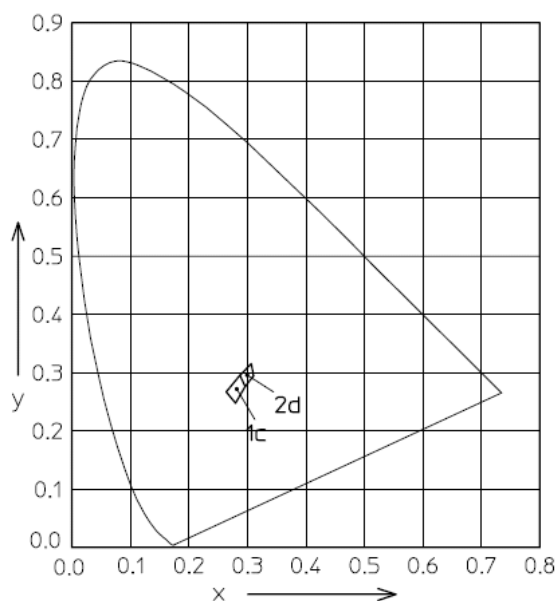

Chromaticity Coordinates Tolerance Each Rank : +/-0.01

Rank	LEFT DOWN point		LEFT UP point		RIGHT UP point		RIGHT UP point	
	x	y	x	y	x	y	x	y
1c	0.280	0.248	0.264	0.267	0.287	0.295	0.296	0.276
2d	0.296	0.276	0.287	0.295	0.307	0.315	0.311	0.294

Please contact our sales staff concerning rank designation.

Technical Data (HSW)

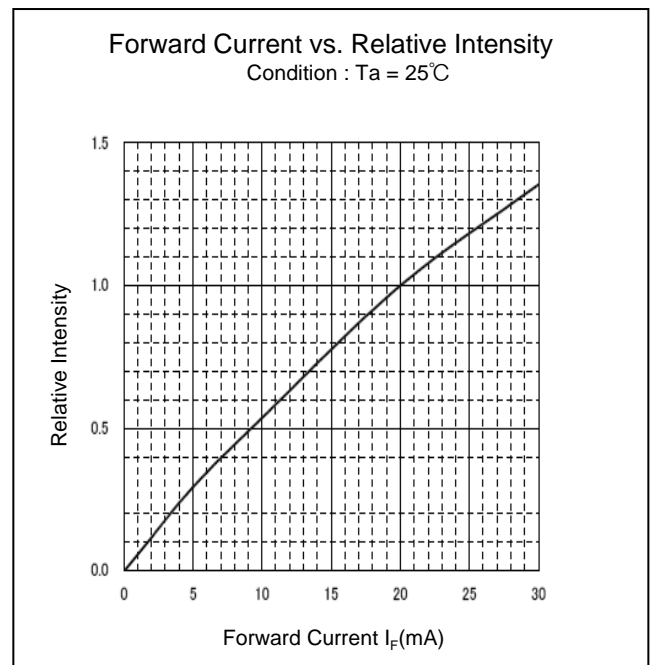
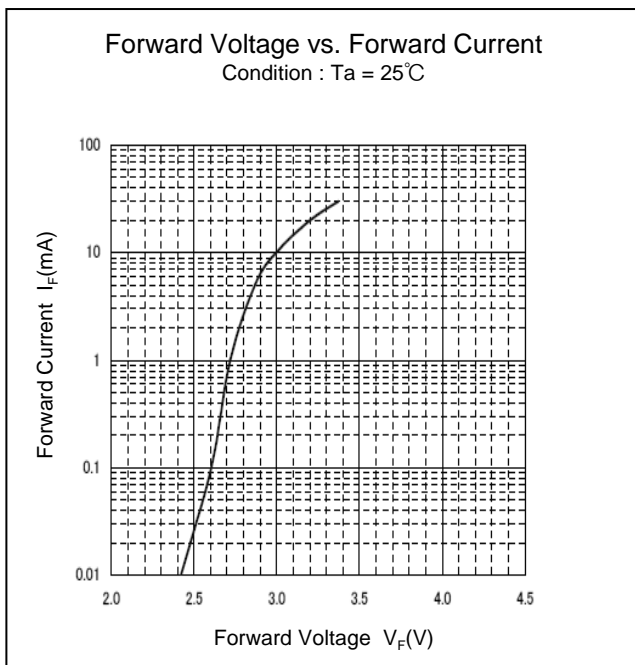
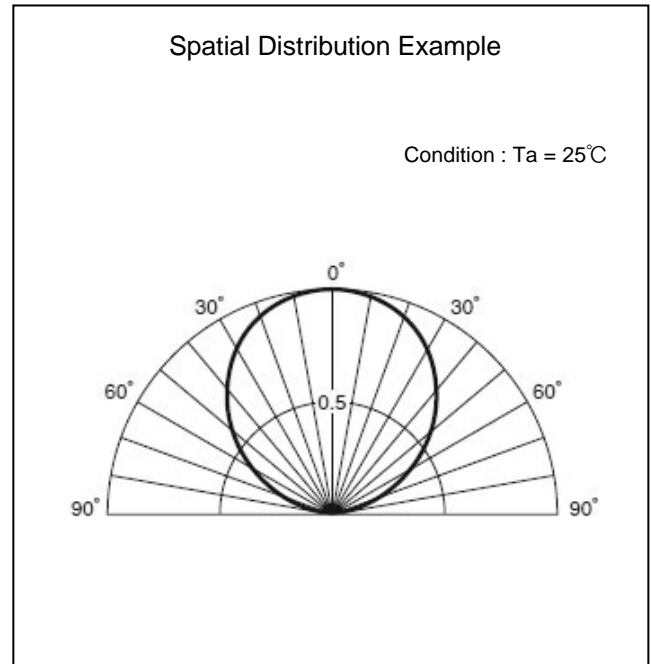
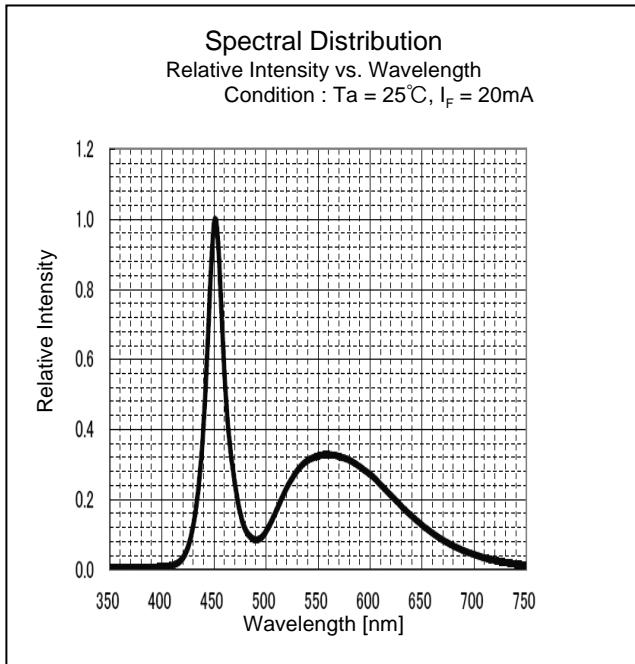

Technical Data (HSW)

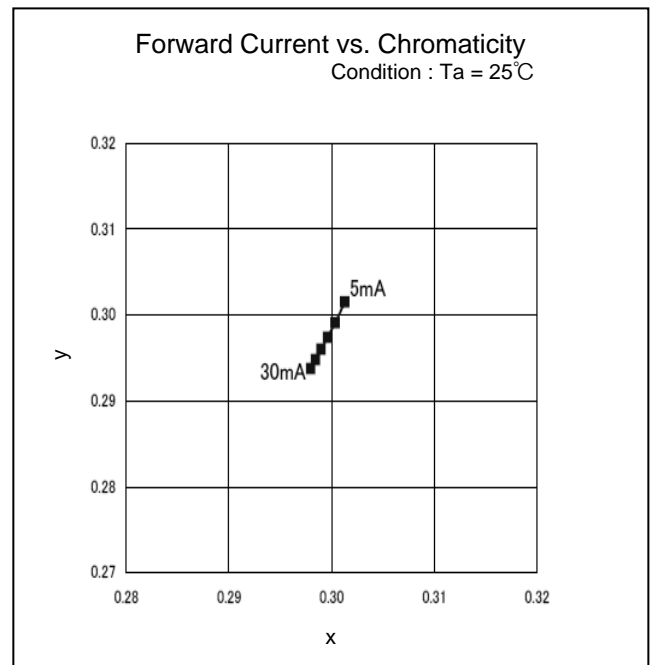
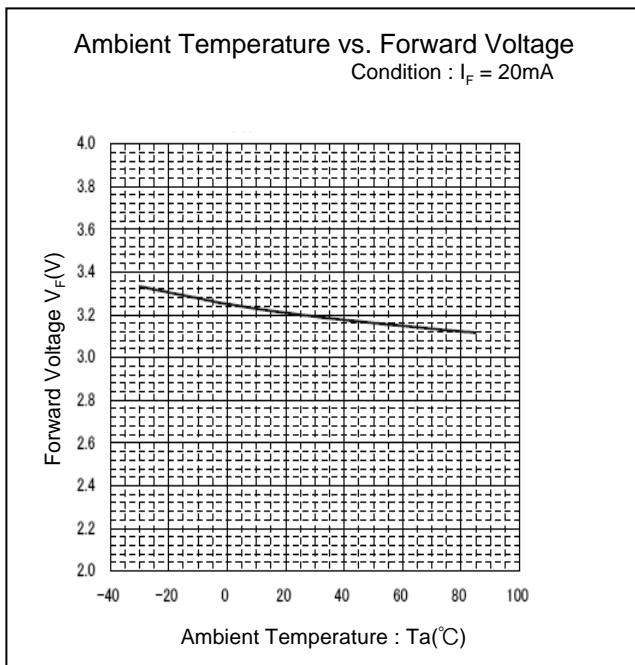
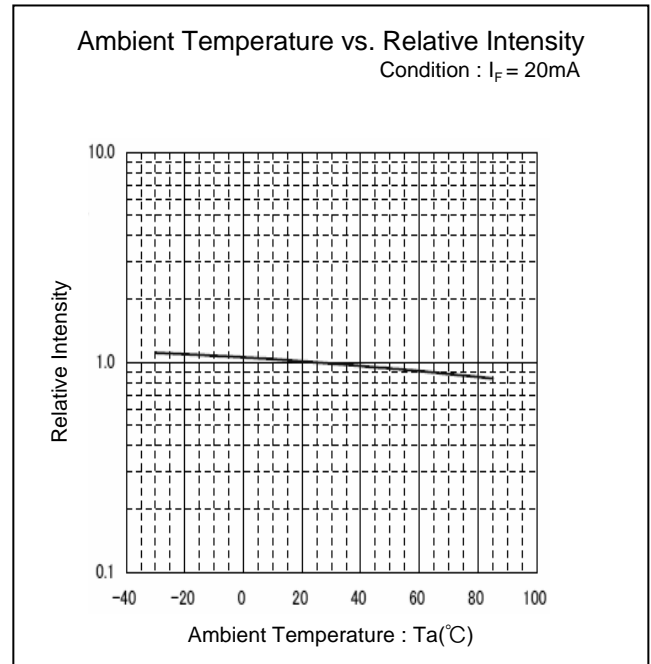
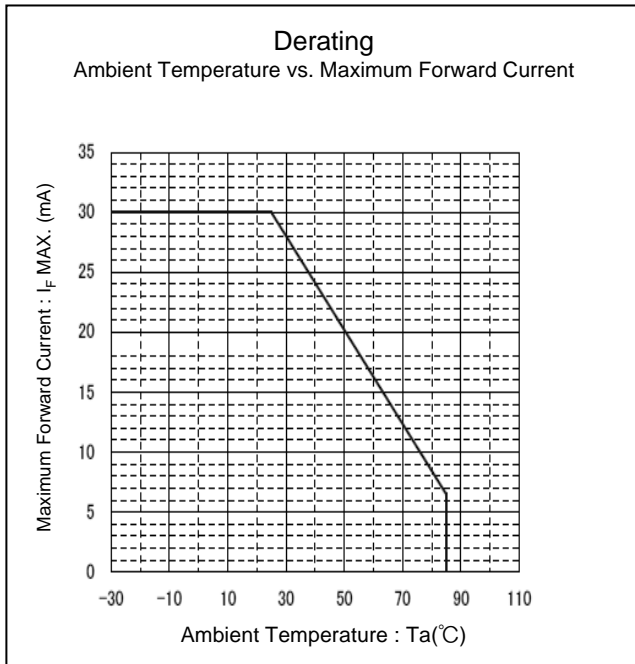

Technical Data (HSW)

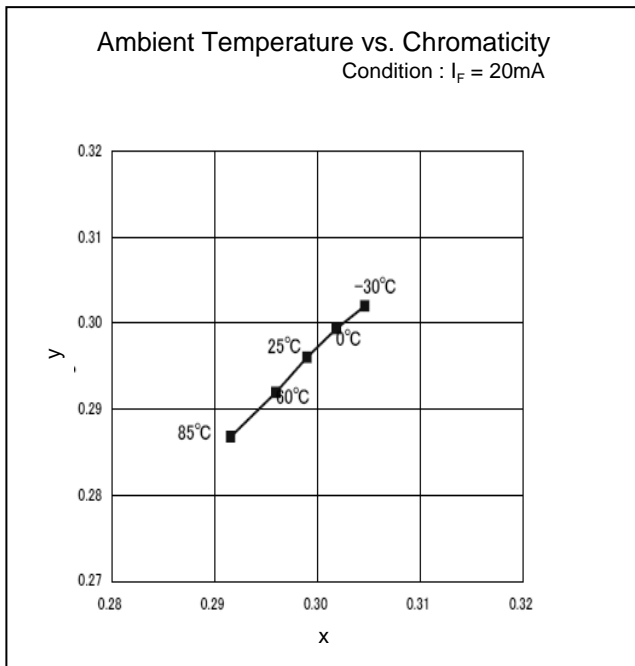

Technical Data (SW)

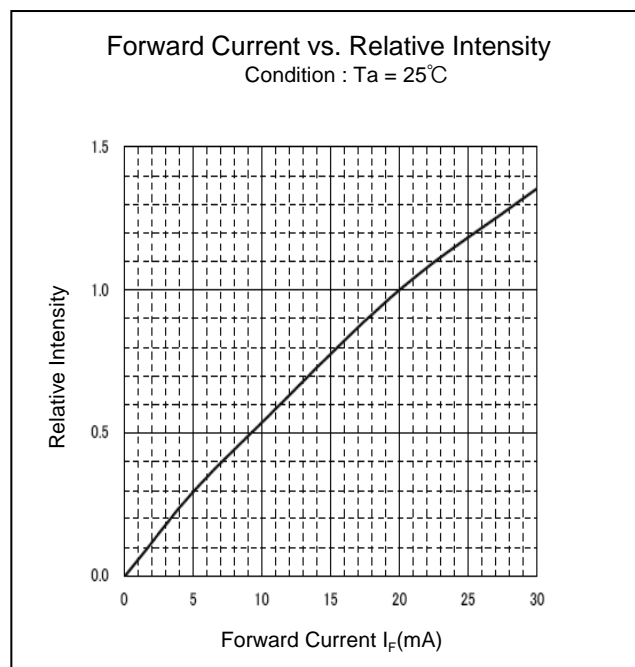
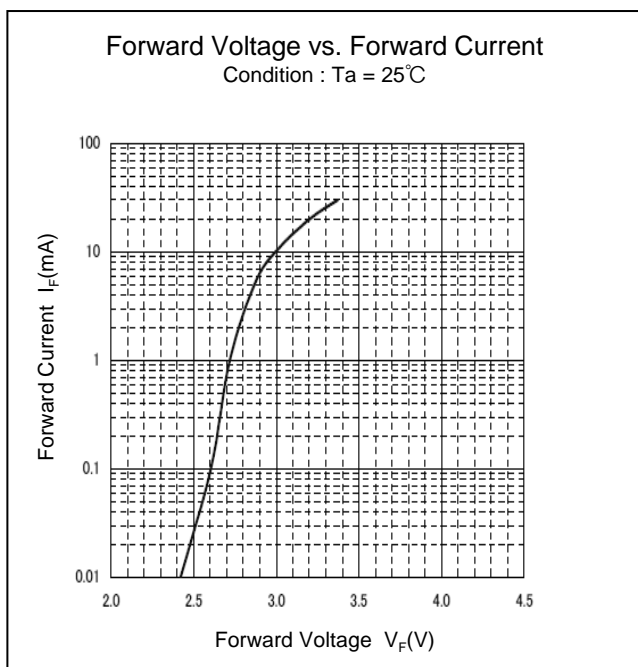
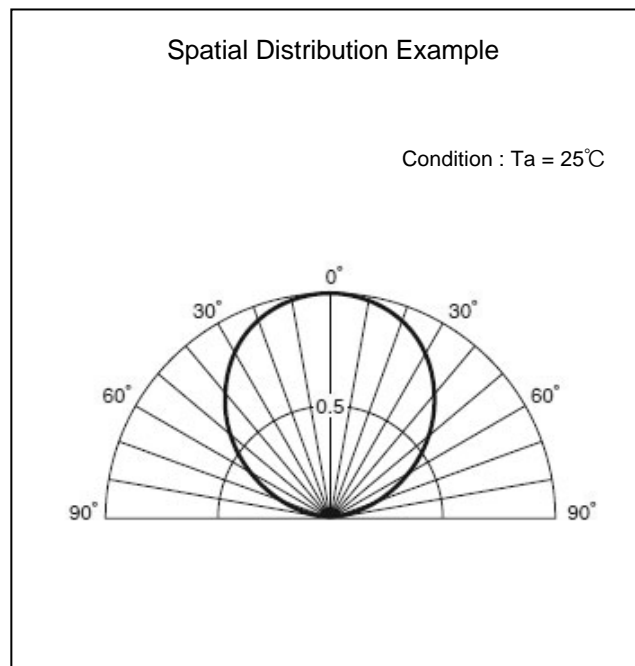
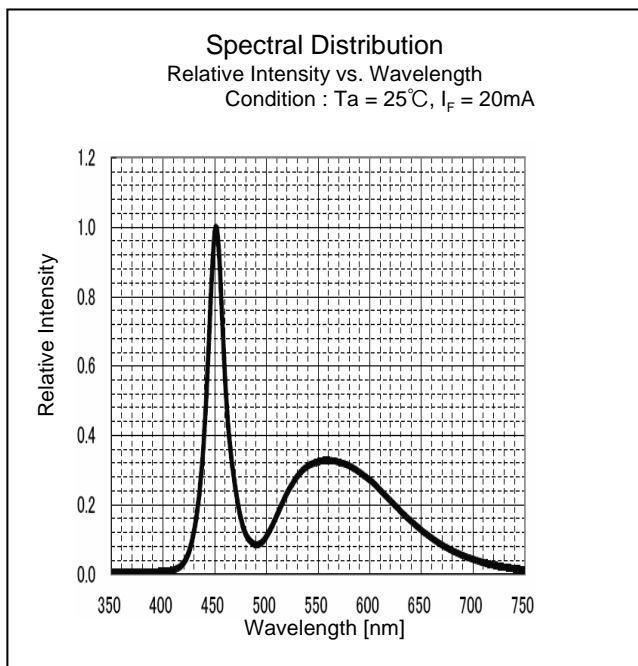

Technical Data (SW)

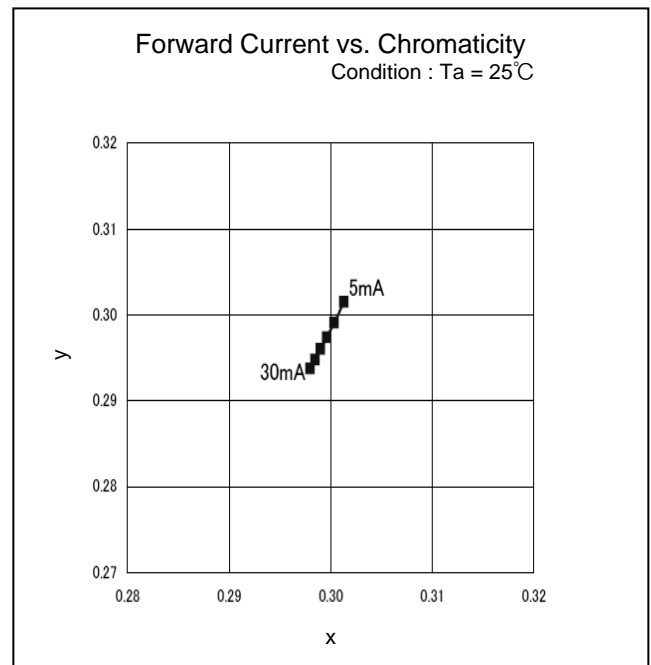
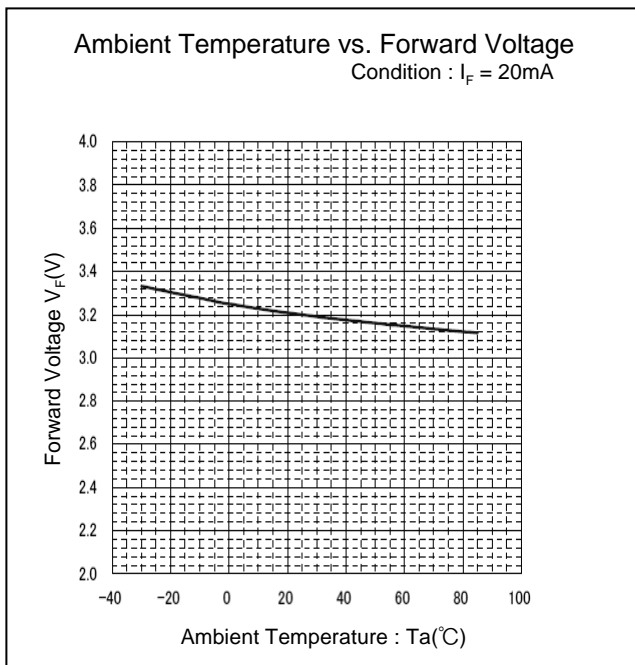
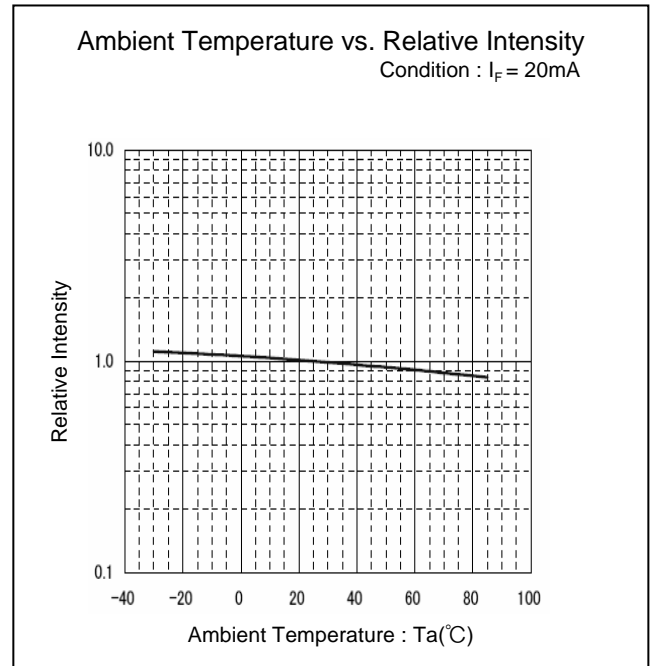
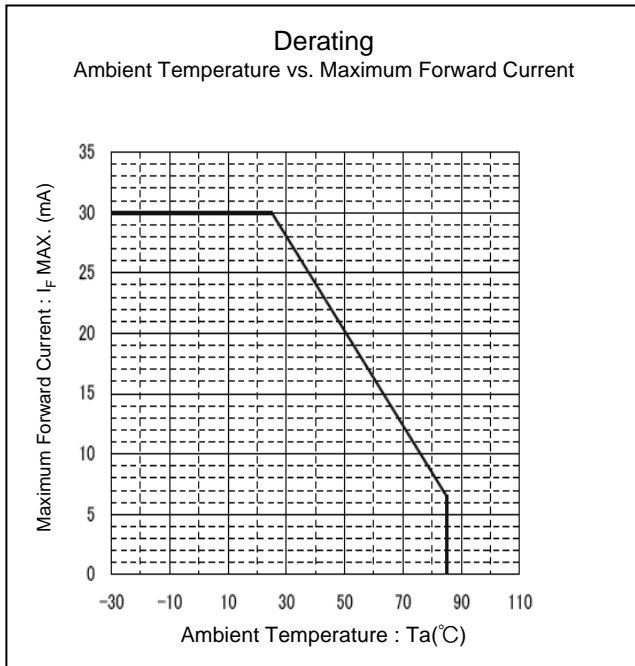

Technical Data (SW)

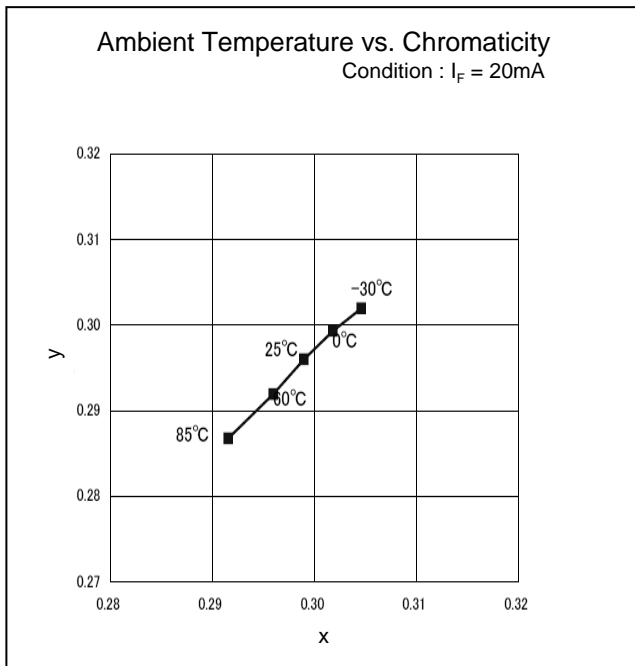

Technical Data (TW)

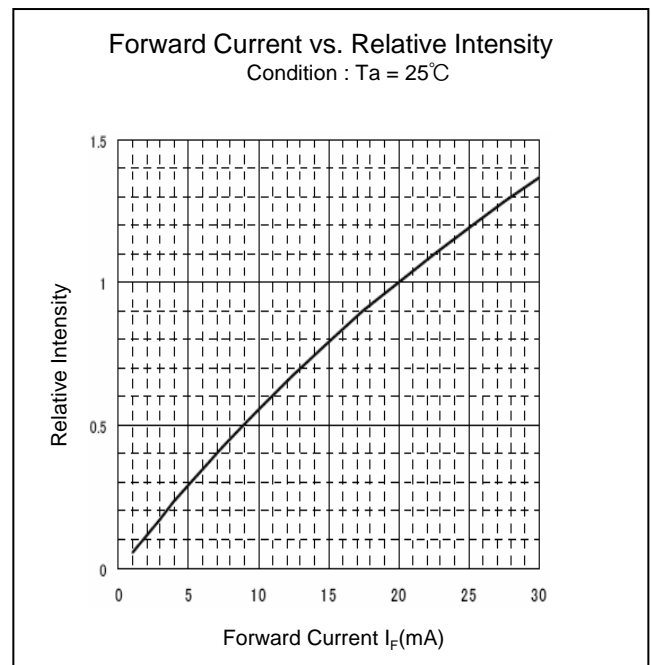
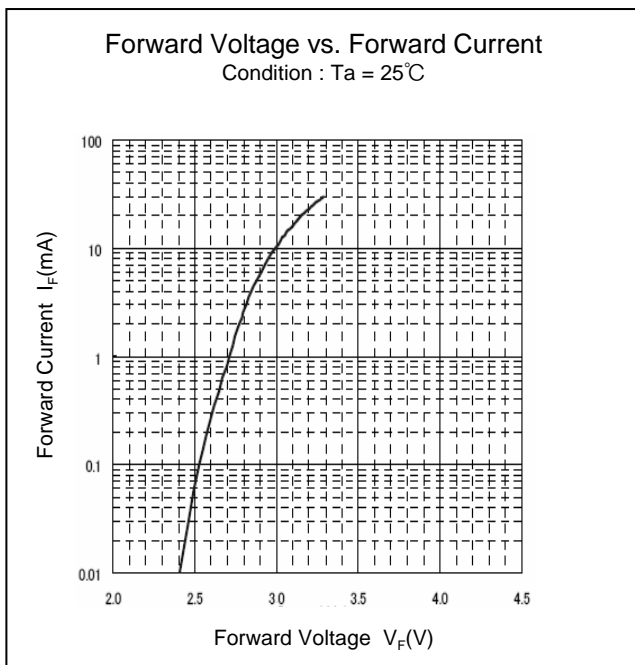
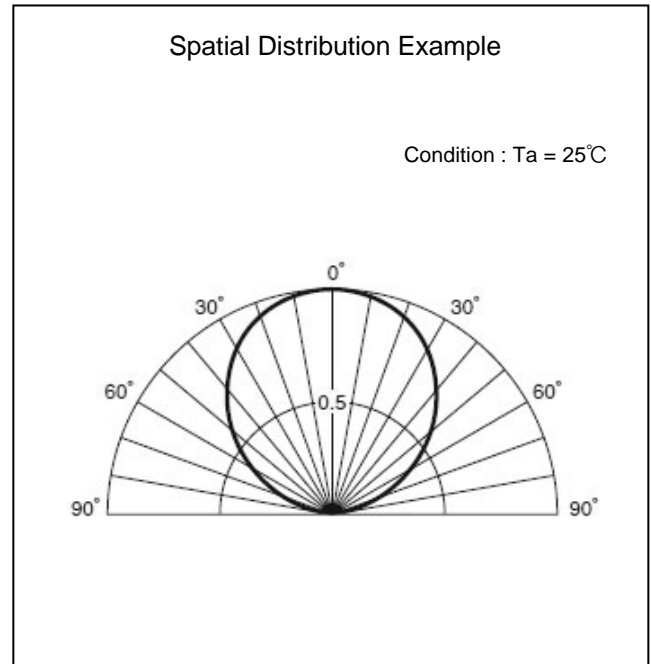
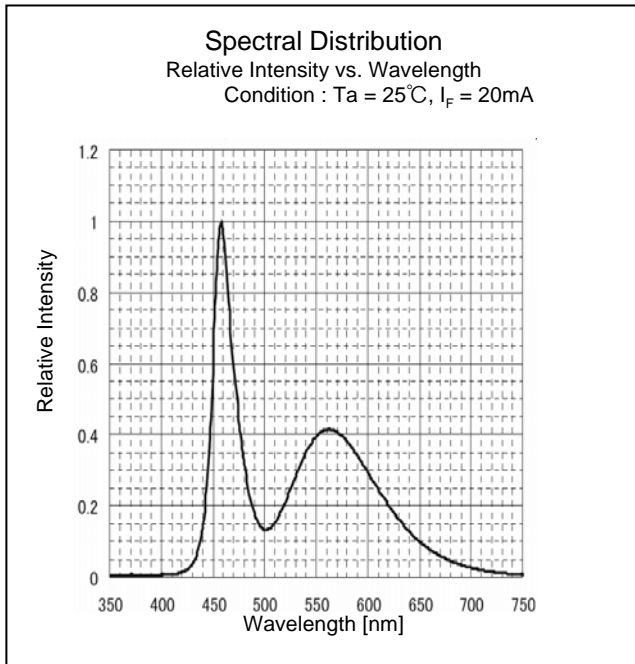

Technical Data (TW)

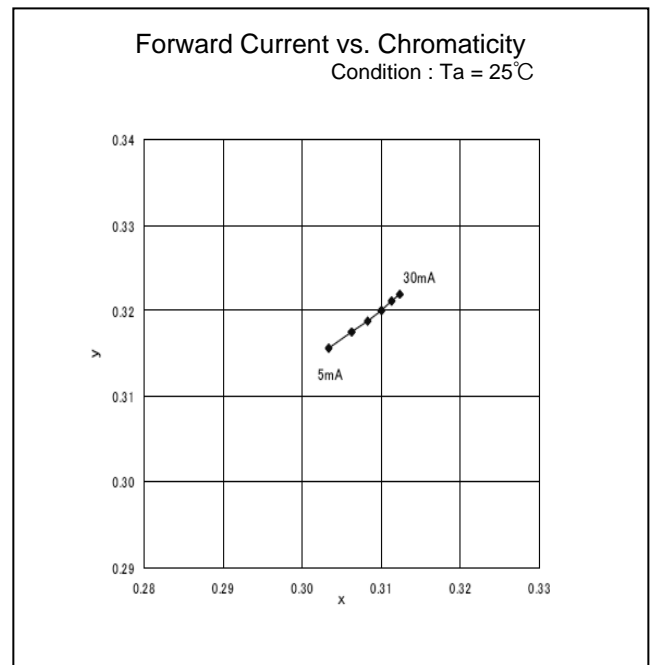
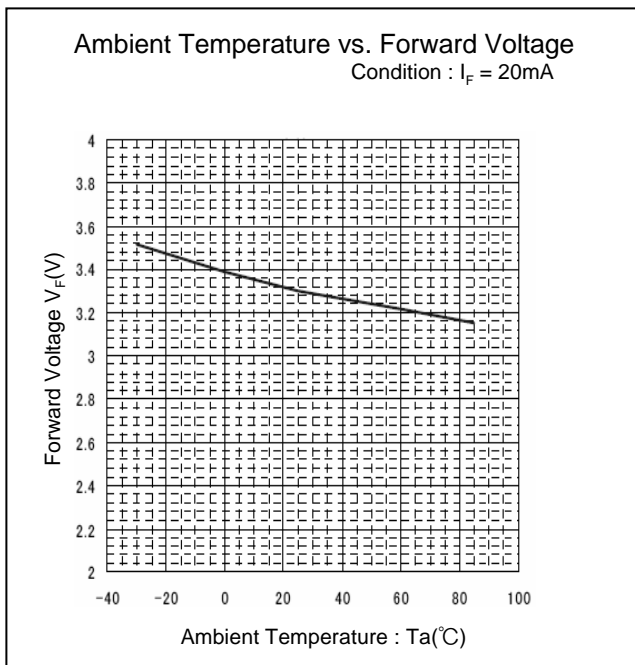
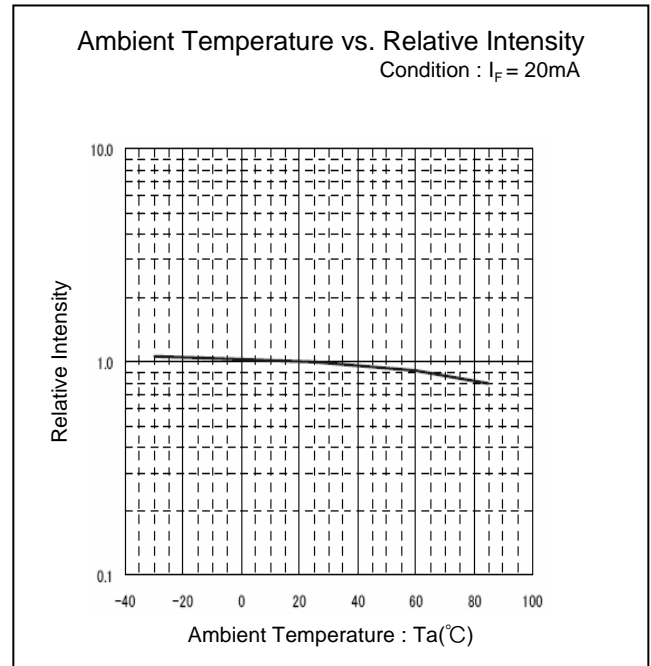
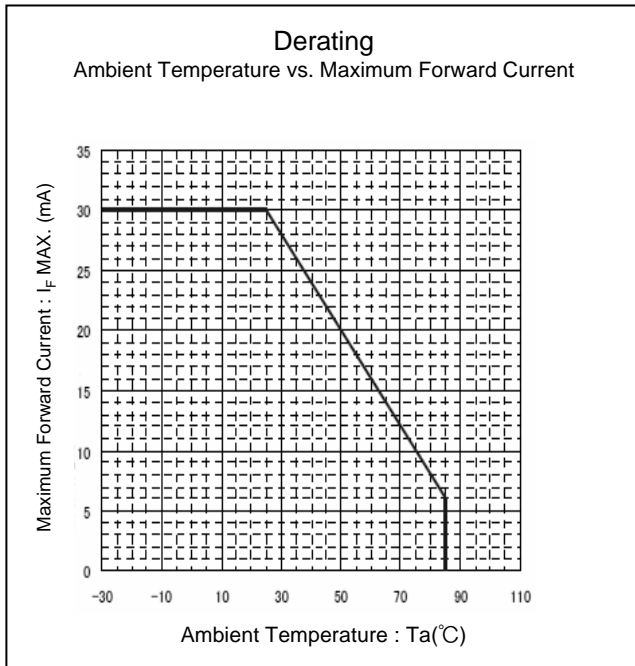

Technical Data (TW)

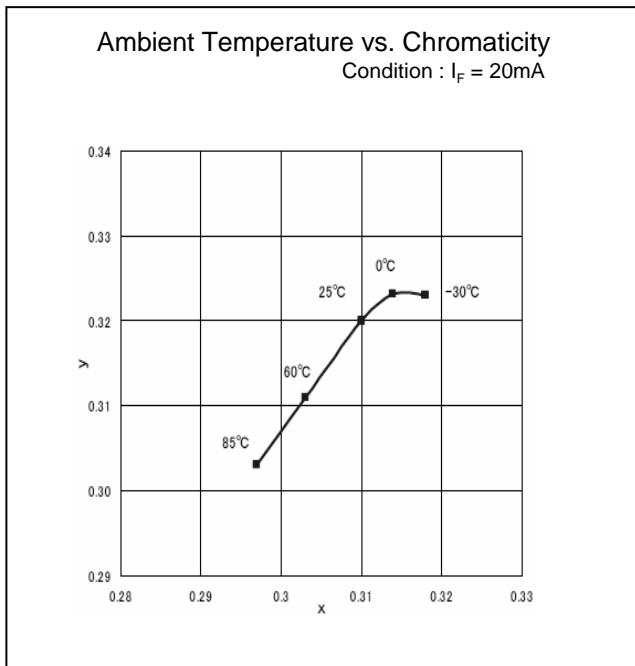

Package Dimensions

(Unit: mm)

Weight: (4.3)mg

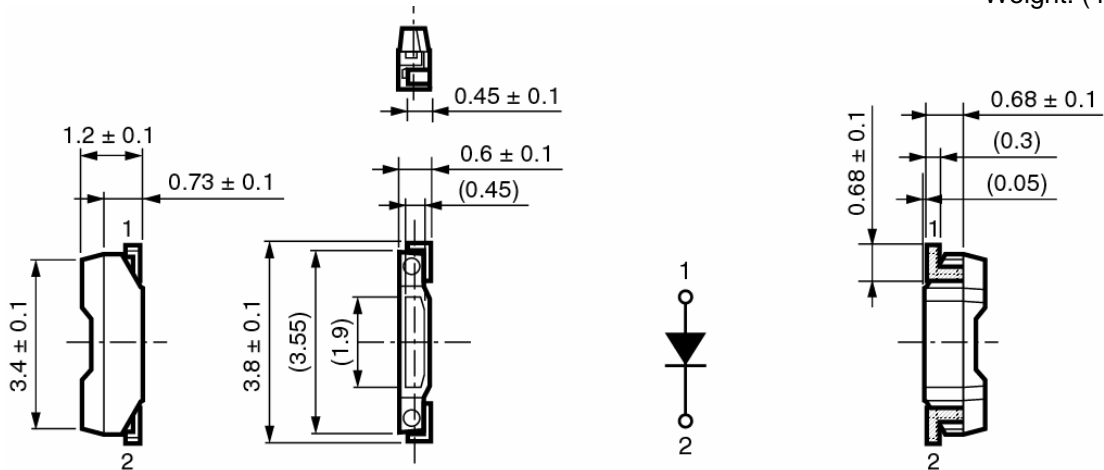

Recommended Soldering Pattern

(Unit: mm)

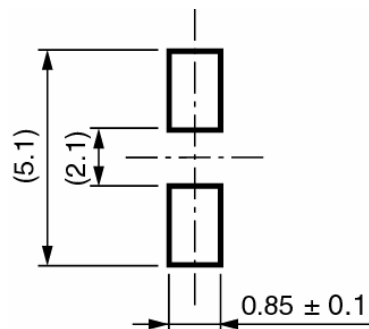

Taping Specification

(Unit: mm)

•Quantity: 3,000pcs/ reel (standard)

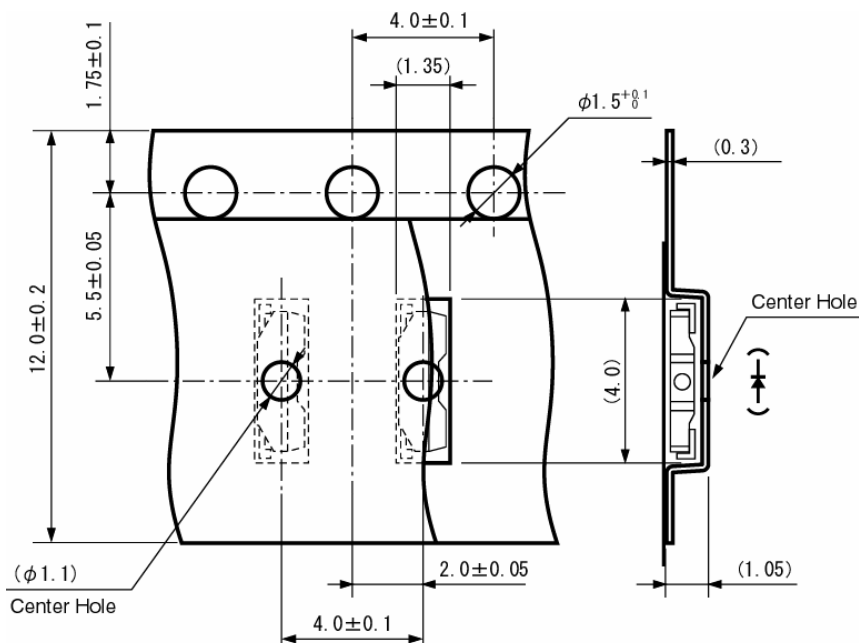

Reflow Soldering Conditions

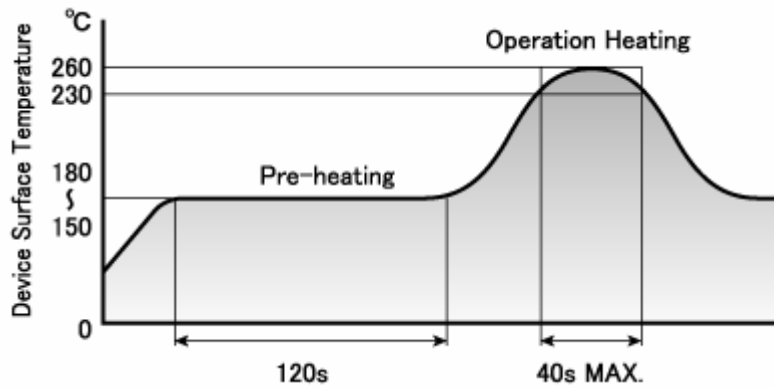

- 1) The above profile temperature gives the maximum temperature of the LED resin surface. Please set the temperature so as to avoid exceeding this range.
- 2) Total times of reflow soldering process shall be no more than 2 times. When the second reflow soldering process is performed, intervals between the first and second reflow should be short as possible (while allowing some time for the component to return to normal temperature after the first reflow) in order to prevent the LED from absorbing moisture.

Manual Soldering Conditions

Iron tip temp.	350 °C	(MAX.)
Soldering time and frequency	3 s	(MAX.)
	1 time	(MAX.)

Reliability Testing Result

Reliability Testing Result	Applicable Standard	Testing Conditions	Duration	Failure
Room Temp. Operating Life	EAJED-4701/100(101)	Ta = 25°C, If = 30mA	1,000 h	0/20
High Temp. Operating Life	EAJED-4701/100(101)	Ta = 85°C, If = 6mA	1,000 h	0/20
Low Temp. Operating Life	EAJED-4701/100(101)	Ta = -30°C, If = 20mA	1,000 h	0/20
Wet High Temp. Operating Life	EAJED-4701/100(102)	Ta = 60°C, 90%, If = 16mA	1,000 h	0/20
Wet High Temp. Storage Life	EAJED-4701/100(103)	Ta = 60°C, 90%	1,000 h	0/20
Thermal Shock	EAJED-4701/100(105)	Ta = -40°C ~ 100°C (each 15min.)	200 cycles	0/20
High Temp. Storage Life	EAJED-4701/200(201)	Ta = 100°C	1,000 h	0/20
Low Temp. Storage Life	EAJED-4701/200(202)	Ta = -40°C	1,000 h	0/20
Cycled Temp. Humidity Life	EAJED-4701/200(203)	Ta = -10°C ~ 65°C, 95%, 24h/cycle	10 cycles	0/20
Resistance to Reflow Soldering	EAJED-4701/300(301)	Preheat : 150 ~ 180°C(120s Max.) Soldering Temp. : 260°C(5s) Moisture Soak : 30°C, 70%, 72h	Twice	0/20
Electric Static Discharge (ESD)	EAJED-4701/300(304)	C = 100pF, R2 = 1.5KΩ, ±1,000V	once each polarity	0/20
Vibration, Variable Frequency	EAJED-4701/400(403)	98.1m/s ² (10G), 100 ~ 2KHz, 20min, XYZ each direction	2 h	0/20

Failure Criteria

Items	Symbols	Conditions	Failure criteria
Luminous Intensity	Iv	If=20mA	Testing Min. Value < Spec. Min. Value x 0.7
Forward Voltage	Vf	If=20mA	Testing Max. Value ≥ Spec. Max. Value x 1.2
Reverse Current	Ir	Vr=5V	Testing Max. Value ≥ Spec. Max. Value x 2.5
Cosmetic Appearance	-	-	Occurrence of notable decoloration, deformation and cracking

Special Notice to Customers Using the Products and Technical Information Shown in This Data Sheet

- 1) The technical information shown in the data sheets are limited to the typical characteristics and circuit examples of the referenced products. It does not constitute the warranting of industrial property nor the granting of any license.
- 2) For the purpose of product improvement, the specifications, characteristics and technical data described in the data sheets are subject to change without prior notice. Therefore it is recommended that the most updated specifications be used in your design.
- 3) When using the products described in the data sheets, please adhere to the maximum ratings for operating voltage, heat dissipation characteristics, and other precautions for use. We are not responsible for any damage which may occur if these specifications are exceeded.
- 4) The products that have been described to this catalog are manufactured so that they will be used for the electrical instrument of the benchmark (OA equipment, telecommunications equipment, AV machine, home appliance and measuring instrument).
The application of aircrafts, space borne application, transportation equipment, medical equipment and nuclear power control equipment, etc. needs a high reliability and safety, and the breakdown and the wrong operation might influence the life or the human body. Please consult us beforehand if you plan to use our product for the usages of aircrafts, space borne application, transportation equipment, medical equipment and nuclear power control equipment, etc. except OA equipment, telecommunications equipment, AV machine, home appliance and measuring instrument.
- 5) In order to export the products or technologies described in this data sheet which are under the "Foreign Exchange and Foreign Trade Control Law," it is necessary to first obtain an export permit from the Japanese government.
- 6) No part of this data sheet may be reprinted or reproduced without prior written permission from Stanley Electric Co., Ltd.
- 7) The most updated edition of this data sheet can be obtained from the address below:
<http://www.stanley-components.com>