

PREPARED BY: <i>H. Okada</i> DATE: <i>Aug. 08. 2011</i>	<b>SHARP</b>  DISPLAY DEVICE BUSINESS GROUP SHARP CORPORATION SPECIFICATION	SPEC No. LCY-10054C
APPROVED BY: <i>[Signature]</i> DATE: <i>Aug 08 2011</i>		FILE No.
		ISSUE: Aug. 08. 2011
		PAGE : 24 pages

DEVICE SPECIFICATION FOR

**TFT - LCD module**

MODEL No. LQ080Y5DZ03

CUSTOMER'S APPROVAL

DATE \_\_\_\_\_

BY \_\_\_\_\_

PRESENTED

BY *T. Makii*

T. Makii  
 Department General Manager  
 Development Dept. II  
 Liquid Crystal Display Division II  
 Display Device Business Group  
 SHARP CORPORATION



## NOTICE

This publication is the proprietary of Sharp Corporation (hereinafter referred to as SHARP) and is copyrighted, with all rights reserved. Under the copyright laws, no part of this publication may be reproduced or transmitted in any form or by any means, electronic or mechanical for any purpose, in whole or in part, without the express written permission of SHARP. Express written permission is also required before any use of this publication may be made by a third party.

The application circuit examples in this publication are provided to explain the representative applications of SHARP's devices and are not intended to guarantee any circuit design or permit any industrial property right or other rights to be executed. SHARP takes no responsibility for any problems related to any industrial property right or a third party resulting from the use of SHARP's devices, except for those resulting directly from device manufacturing processes.

In the absence of confirmation by device specification sheets, SHARP takes no responsibility for any defects that occur in equipment using any of SHARP's devices, shown in catalogs, data books, etc. Contact SHARP in order to obtain the latest device specification sheets before using any SHARP's device.

SHARP reserves the right to make changes in the specifications, characteristics, data, materials, structures and other contents described herein at any time without notice in order to improve design or reliability. Contact SHARP in order to obtain the latest specification sheets before using any SHARP's device. Manufacturing locations are also subject to change without notice.

Observe the following points when using any device in this publication. SHARP takes no responsibility for damage caused by improper use of the devices.

The devices in this publication are designed for use in general electronic equipment designs, such as:

- Car Navigation system
- Automotive auxiliary information display
- Automotive audio visual equipment

The appropriate design measures should be taken to ensure reliability and safety when SHARP's devices are used for equipment such as:

- Transportation control and safety equipment (i.e. aircraft, trains, automobiles, etc.)
- Traffic signals
- Gas leakage sensor breakers
- Alarm equipment
- Various safety devices etc.

SHARP's devices shall not be used for equipment that requires extremely high level of reliability, such as:

- Military and space applications
- Nuclear power control equipment
- Medical equipment for life support

Contact a SHARP representative, in advance, when intending to use SHARP's devices for any "specific" applications other than those recommended by SHARP.

Contact and consult with a SHARP representative if there are any questions about the contents of this publication.

## 1. General

This TFT-LCD module is a color active matrix LCD (Liquid Crystal Display) module of transmissive type incorporating amorphous silicon TFT (Thin Film Transistor).

General specification of the module is shown in the Table 3-1.

It is composed of a color TFT-LCD panel, driver ICs, control-PWB, FPC, frame, shielding front case, shielding back case and backlight unit.

## 2. Features

- Utilizes a panel with a 15:9 aspect ratio, which makes the module suitable for use in wide-screen systems.
- The 8.0 inch screen produces a high resolution image that is composed of 384,000 pixels elements in a stripe arrangement.
- Graphics and texts can be displayed on a 800×RGB×480 dots panel with 262,144 colors by supplying 18 bits (6 bits×RGB) data signal.
- Wide viewing field angle technology is employed.
- By adopting an active matrix drive, a picture with high contrast is realized.
- Reduced reflection as a result of low reflection black matrix and an antiglare (AG) and antireflection (AR) polarizer being adopted. The reflectance is 1.5% Typical.
- By COG method, realized a slim, lightweight, and compact module.
- Realized a high quality picture of the natural color appearance by adopting Normally Black Mode which is superior to the color appearance.
- An inverted video display in the vertical and horizontal directions is possible.
- The backlight is excellent of brightness rising characteristics at low temperature in consideration of automotive application.
- Minimized image flicker artifacts by implementing checker pattern dot inversion driving scheme

## 3. Mechanical specifications (Dot Composition)

General Specification of the Module Table 3-1

Parameter	Specifications	Units	Remarks
Display format	384,000	pixels	
	800(RGB)W×480H	dots	
Active area	174.0(W)×104.4(H)	mm	
Screen size (Diagonal)	20.3 [ 8.0 “ ]	cm	
Dot pitch	0.0725(W)×0.2175(H)	mm	
Pixel configuration	R,G,B Stripe configuration		
Outline dimension	191.8 (W)×120.0 (H)×13.5(D)	mm	[Note 3-1]
Mass	400(Typ.)	g	

[Note 3-1]

Excluding protrusions. Typical values are given.

For detailed measurements and tolerances, please refer to Fig. 1.

**4. Input terminal and its function**

4-1 TFT-LCD panel driving part : Connector used : FH41-68S-0.5SH(05) (HRS)

Table 4-1

Pin No.	Symbol	Description	Remarks
1	TEST	Continuity to pin 68	
2	GND	GND for circuit	
3	GND	GND for circuit	
4	GND	GND for circuit	
5	GND	GND for circuit	
6	GND	GND for circuit	
7	N.C.	OPEN	
8	B+	POWER for LED circuit	
9	B+	POWER for LED circuit	
10	B+	POWER for LED circuit	
11	B+	POWER for LED circuit	
12	B+	POWER for LED circuit	
13	N.C.	OPEN	
14	GND	GND for circuit	
15	GND	GND for circuit	
16	GND	GND for circuit	
17	GND	GND for circuit	
18	GND	GND for circuit	
19	GND	GND for circuit	
20	BL_PWM	PWM control for LED driver	
21	N.C.	OPEN	
22	THM1	Thermistor	[Note4-5]
23	THM2	Thermistor	[Note4-5]
24	GND	GND for circuit	
25	VRV	Turning the direction of vertical scanning	[Note4-4]
26	HRV	Turning the direction of horizontal scanning	[Note4-3]
27	GND	GND for circuit	
28	N.C.	OPEN	
29	VCC	Logical Power Supply (+3.3V power supply)	
30	VCC	Logical Power Supply (+3.3V power supply)	
31	VCC	Logical Power Supply (+3.3V power supply)	
32	N.C.	OPEN	
33	GND	GND for circuit	
34	R5	RED data signal (MSB)	
35	R4	RED data signal	
36	R3	RED data signal	
37	R2	RED data signal	
38	R1	RED data signal	
39	R0	RED data signal (LSB)	
40	GND	GND for circuit	
41	G5	GREEN data signal (MSB)	
42	G4	GREEN data signal	
43	G3	GREEN data signal	
44	G2	GREEN data signal	
45	G1	GREEN data signal	
46	G0	GREEN data signal (LSB)	
47	GND	GND for circuit	
Pin No.	Symbol	Description	Remarks

48	B5	BLUE data signal (MSB)	
49	B4	BLUE data signal	
50	B3	BLUE data signal	
51	B2	BLUE data signal	
52	B1	BLUE data signal	
53	B0	BLUE data signal (LSB)	
54	GND	GND for circuit	
55	PON	Display reset signal	
56	GND	GND for circuit	
57	GND	GND for circuit	
58	NCLK	Clock signal for sampling each data signal	
59	GND	GND for circuit	
60	GND	GND for circuit	
61	VD	Vertical sync	[Note4-1]
62	DEN	Horizontal Data Enable	[Note4-2]
63	HD	Horizontal sync	[Note4-1]
64	GND	GND for circuit	
65	GND	GND for circuit	
66	GND	GND for circuit	
67	GND	GND for circuit	
68	TEST	Continuity to pin 1	

[Note4-1]

Hsync	Negative polarity
Vsync	Negative polarity

[Note4-2] The horizontal display starting position is settled in accordance with a rising timing of DEN signal. (Refer to Fig.2)

In case DEN is fixed to "Low", the horizontal display starting position is determined as described in Fig.2.(Don't keep DataEn "High" during operation.)

[Note4-3] HRV="Hi" : Regular video  
 HRV="Lo" : Horizontally inverted video

[Note4-4] VRV="Hi" : Regular video  
 VRV="Lo" : Vertically inverted video

[Note4-5] Thermistor parts number : NSM2103F344F3 (OHIZUMI)

5. Absolute maximum ratings

Table 5-1

GND=0V

Parameter	Symbol	MIN	MAX	Unit	Note
Input voltage for back light	VB+	-0.3	23.0	V	21V~23V Max 1s
+3.3V power supply	Vcc	-0.3	+4.6	V	
Input signal voltage 1	Vi1	-0.3	Vcc+0.3	V	[Note5-1]
Input signal voltage 2	Vi2	-0.3	"VB+" +0.3	V	[Note5-2]
Storage temperature	Tstg	-40	95	°C	[Note5-3,4]
Operating temperature (LCD panel surface)	Topr1	-30	85	°C	[Note5-3,4,5,6]
Operating temperature ( Ambient temperature )	Topr2	-40	85	°C	[Note5-6]

[Note5-1] HD , DEN , VD , NCLK , B0~B5 , G0~G5 , R0~R5 , HRV , VRV , PON

[Note5-2] BL\_PWM

[Note5-3] This rating applies to all parts of the module and should not be exceeded.

The specified temperature provides the maximum value within 5mm around the module.

[Note5-4] Maximum wet-bulb temperature is to be less than 58°C. Condensation of dew must be avoided as electrical current leaks will occur, causing a degradation of performance specifications.

[Note5-5] The operating temperature only guarantees operation of the circuit. Specifications (contrast ratio, response time and other factors related to display quality) are determining at ambient temperature (Ta=25°C) .

[Note5-6] Ambient temperature when the backlight is lit. (by PWM).

PWM dimming shall operate at  $T_a \geq +75^\circ\text{C}$ . (See attached below figure)  $\Delta 1$

(Thermistor value shall be controlled more than 1.3KΩ)  $\Delta 1$

The display reduce performance level between  $-40^\circ\text{C} \leq T_a \leq -30^\circ\text{C}$  and  $+75^\circ\text{C} \leq T_a \leq +85^\circ\text{C}$   $\Delta 1$

For reference when being with a Touch Panel, PWM dimming shall operate at  $T_a \geq +70^\circ\text{C}$ .  $\Delta 1$   
(Thermistor value shall be controlled more than 1.35KΩ)

Countermeasures for heat generation from LCD module such as heat sink are mandatory at customer's system.

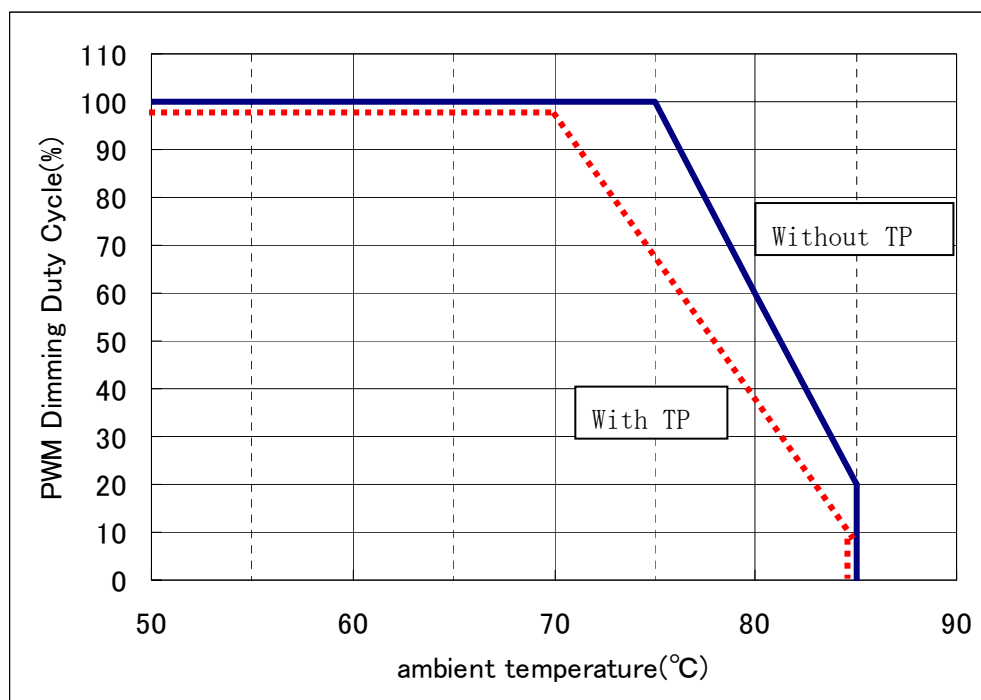

[Note5-7] The above graph is reference data as LCD module

**6. Electrical characteristics**

6-1 TFT-LCD panel driving section

Table 6-1

Ta= 25°C

Parameter		Symbol	MIN	TYP	MAX	Unit	Remarks
B+	Supply voltage	VB+	7.0	13.5	18.0	V	[Note6-1]
	Current dissipation	VB+	—	450	1000	mA	Max:VB+=7V
Input Low voltage		V <sub>IBL</sub>	GND	—	0.4	V	“BL_PWM”terminal
Input High voltage		V <sub>IBH</sub>	2.1	—	5.5	V	
VCC	Supply voltage	V <sub>CC</sub>	+3.0	+3.3	+3.6	V	[Note6-1]
	Current dissipation	I <sub>CC</sub>	—	260	350	mA	[Note6-2]
Permissive input ripple		V <sub>RF</sub>	—	—	100	mV <sub>pp</sub>	
Input Low voltage		V <sub>IL</sub>	GND	—	0.3V <sub>CC</sub>	V	[Note6-3]
Input High voltage		V <sub>IH</sub>	0.7V <sub>CC</sub>	—	V <sub>CC</sub>	V	
Negative trigger voltage		V <sub>NT</sub>	0.8	—	1.6	V	“PON” terminal
Positive trigger voltage		V <sub>PT</sub>	1.4	—	2.4	V	
Hysteresis voltage		V <sub>HYS</sub>	0.3	—	1.5	V	
Input current 1 (Low)		I <sub>IL1</sub>	—	—	2.0	μA	V <sub>I</sub> =0V or V <sub>CC</sub> [Note 6-4]
Input current 1 (High)		I <sub>IH1</sub>	—	—	2.0	μA	
Input current 2(Low)		I <sub>IL2</sub>	30	—	200	μA	V <sub>I</sub> =0V or V <sub>CC</sub> “HD,VD” terminal
Input current 2 (High)		I <sub>IH2</sub>	—	—	2.0	μA	
Input current 3 (Low)		I <sub>IL3</sub>	—	—	2.0	μA	V <sub>I</sub> =0V or V <sub>CC</sub> “DEN” terminal
Input current 3 (High)		I <sub>IH3</sub>	30	—	200	μA	
Input current 4 (Low)		I <sub>IL4</sub>	—	—	600	μA	V <sub>I</sub> =0V or V <sub>CC</sub> “HRV,VRV” terminal
Input current 4 (High)		I <sub>IH4</sub>	—	—	2.0	μA	
Input current 5 (Low)		I <sub>IL5</sub>	—	—	1.0	μA	V <sub>IB</sub> =0V or 5.5V “BL_PWM” terminal
Input current 5 (High)		I <sub>IH5</sub>	—	—	600	μA	

[Note6-1]

On-off conditions for supply voltage

- 0 < t<sub>1</sub>
- 0 < t<sub>2</sub> ≤ 10ms
- 0 < t<sub>3</sub> ≤ 1s
- t<sub>4</sub> ≥ 1s
- 0 < t<sub>5</sub> ≤ 10ms
- t<sub>6</sub> ≤ 10ms
- 0ms ≤ t<sub>7</sub>

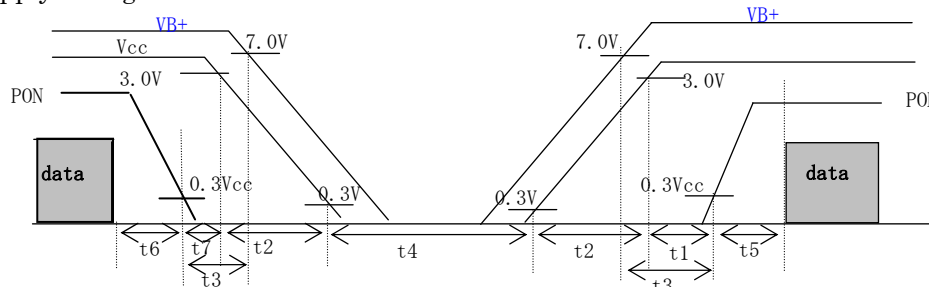

\*When PON signal turns off, display pattern may be un-controlled for an instant.

[Note6-2]

Typical current situation: White (GS63) pattern

Timing: Typical

VCC= +3.3 V

[Note 6-3]

HD , DEN , VD , NCLK , B0~B5 , G0~G5 , R0~R5 , HRV , VRV

[Note 6-4]

NCLK , B0~B5 , G0~G5 , R0~R5 , PON



## 7. Timing Characteristics of input signals

### 7-1) Timing characteristics

Table 7-1

Ta= 25°C

Parameter		Symbol	Min.	Typ.	Max.	Unit	Note
Clock [NCLK]	Frequency	fCLK	31.95	33.26	34.60	MHz	
	Hi_Time	tWCH	5	—	—	ns	
	Lo_Time	tWCL	5	—	—	ns	
Data [I* 0-5]	Setup time	tDS	5	—	—	ns	
	Hold time	tDH	5	—	—	ns	
Horizontal sync.signal [HD]	Cycle	tH(t)	31.45	31.75	32.05	μs	
		tH(clk)	1024	1056	1088	ck	
	Pulse width	tHPW	5	—	THb-5	ck	
Vertical sync. Signal [VD]	Cycle	tV	520	525	530	line	
	Pulse width	tVPW	2	—	TV-2	line	
Frame rate		fV	50	60	60	Hz	
Horizontal display period		tHA	800			ck	only 800ck
HD_NCLK phase difference		tHC	A-8	A	A+8	ns	A=Tc/2 (Tc=1/fCLK)
HD_VD phase difference		tVH	-10	0	10	ck	
Vertical front porch		tVFP	5	—	—	line	
Vertical back porch		tVBP	35			line	only 35 line
Vertical display period		tVA	480			line	only 480 line
Enable signal [HENAB]	Setup time	tES	5	—	—	ns	[Note 7-1]
	Hold time	tHE	5	—	—	ns	
	Pulse width	tEP	800			ck	[Note 7-1] only 800ck
Horizontal front porch		tHFP	2	—	—	ck	
Horizontal back porch		tHBP	194			ck	[Note 7-2] only 194ck
			20	—	222	ck	[Note 7-3]
PWM Dimming Frequency		fpwm	150	—	250	Hz	BL_PWM
PWM Dimming Duty Cycle			1.0	—	100	%	Δ 1

[Note 7-1] Enable signal must be input into Vertical invalid data period as well as Vertical display period.

[Note 7-2] This spec is applied for DEN Low fix mode.

[Note 7-3] This spec is applied for DEN active mode.

7-2) Input Data Signals and Display Position on the screen  
Refer to the following figure

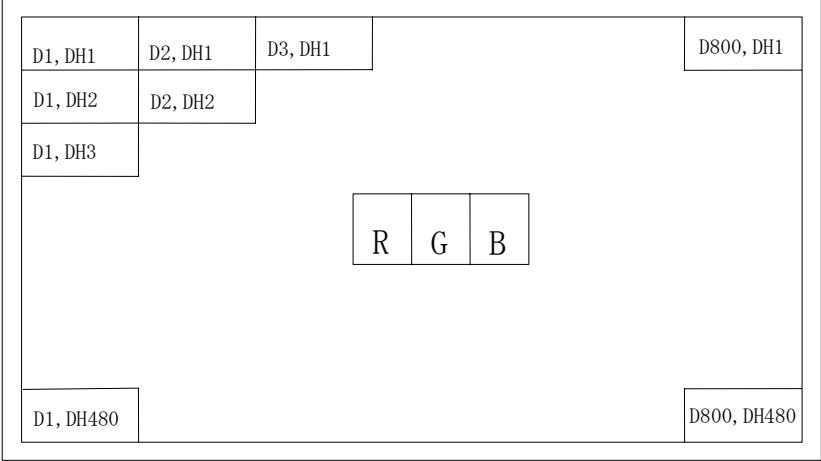

Display position of input data (H,V)

8. Input Signals, Basic Display Color and Gray Scale of Each Color

Table 8-1

Colors & Gray scale	Gray Scale	Data signal																		
		R0	R1	R2	R3	R4	R5	G0	G1	G2	G3	G4	G5	B0	B1	B2	B3	B4	B5	
Basic color	Black	—	0	0	0	0	0	0	0	0	0	0	0	0	0	0	0	0	0	0
	Blue	—	0	0	0	0	0	0	0	0	0	0	0	0	1	1	1	1	1	1
	Green	—	0	0	0	0	0	0	1	1	1	1	1	1	0	0	0	0	0	0
	Cyan	—	0	0	0	0	0	0	1	1	1	1	1	1	1	1	1	1	1	1
	Red	—	1	1	1	1	1	1	0	0	0	0	0	0	0	0	0	0	0	0
	Magenta	—	1	1	1	1	1	1	0	0	0	0	0	0	1	1	1	1	1	1
	Yellow	—	1	1	1	1	1	1	1	1	1	1	1	1	0	0	0	0	0	0
	White	—	1	1	1	1	1	1	1	1	1	1	1	1	1	1	1	1	1	1
Gray Scale of red	Black	GS0	0	0	0	0	0	0	0	0	0	0	0	0	0	0	0	0	0	0
	↑	GS1	1	0	0	0	0	0	0	0	0	0	0	0	0	0	0	0	0	0
	Darker	GS2	0	1	0	0	0	0	0	0	0	0	0	0	0	0	0	0	0	0
	↑	↓				↓					↓					↓				
	↓	↓				↓					↓					↓				
	Brighter	GS61	1	0	1	1	1	1	0	0	0	0	0	0	0	0	0	0	0	0
	↓	GS62	0	1	1	1	1	1	0	0	0	0	0	0	0	0	0	0	0	0
	Red	GS63	1	1	1	1	1	1	0	0	0	0	0	0	0	0	0	0	0	0
Gray Scale of green	Black	GS0	0	0	0	0	0	0	0	0	0	0	0	0	0	0	0	0	0	0
	↑	GS1	0	0	0	0	0	0	1	0	0	0	0	0	0	0	0	0	0	0
	Darker	GS2	0	0	0	0	0	0	0	1	0	0	0	0	0	0	0	0	0	0
	↑	↓				↓					↓					↓				
	↓	↓				↓					↓					↓				
	Brighter	GS61	0	0	0	0	0	0	1	0	1	1	1	1	0	0	0	0	0	0
	↓	GS62	0	0	0	0	0	0	0	1	1	1	1	1	0	0	0	0	0	0
	Green	GS63	0	0	0	0	0	0	1	1	1	1	1	1	0	0	0	0	0	0
Gray Scale of bleu	Black	GS0	0	0	0	0	0	0	0	0	0	0	0	0	0	0	0	0	0	0
	↑	GS1	0	0	0	0	0	0	0	0	0	0	0	0	1	0	0	0	0	0
	Darker	GS2	0	0	0	0	0	0	0	0	0	0	0	0	0	1	0	0	0	0
	↑	↓				↓					↓					↓				
	↓	↓				↓					↓					↓				
	Brighter	GS61	0	0	0	0	0	0	0	0	0	0	0	0	1	0	1	1	1	1
	↓	GS62	0	0	0	0	0	0	0	0	0	0	0	0	0	1	1	1	1	1
	Bleu	GS63	0	0	0	0	0	0	0	0	0	0	0	0	1	1	1	1	1	1

Each basic color can be displayed in 64 gray scales by 6 bit data signals. According to the combination of total 18 bit data signals, the 262,144-color display can be achieved on the screen.

9. Optical characteristics

Table 9-1

Ta=25°C , Vcc=+3.3V , VB+=13.5V , BL\_PWM=100% ,Initial Value

Parameter	Symbol	Condition	Min	Typ	Max	Unit	Remarks	
Viewing Angle Range	021,022	CR≥10	70	85	-	degree	【Note 9-1,2】	
	011,012		70	85	-	degree		
Contrast ratio	CRmax	θ=0°	1100	2000	-		【Note 9-2】	
Response time	Rise		τr	-	15	35	ms	【Note 9-3】
	Fall		τd	-	5	15	ms	
Color Chromaticity	x (white)		0.255	0.290	0.330		±0.03 NTSC ratio is Typ64%.	
	y (white)		0.280	0.320	0.360			
	x (red)		0.590	0.620	0.650			
	y (red)		0.320	0.350	0.380			
	x (green)		0.290	0.320	0.350			
	y (green)	0.590	0.620	0.650				
	x (blue)	0.120	0.150	0.180				
Luminance	Y	450	645	-	cd/m <sup>2</sup>			
Off-Axis Half Brightness	021,022	-	35	45	-	degree	【Note 9-1】	
	011,012	-	20	30	-	degree		
Uniformity	u	-	-	85	-	%	【Note 9-5】	
LED lifetime	+25°C	-	continuation	10,000	-	-	hour	【Note 9-4】

※Above specification warrants only initial condition.

※Measured after 30 minutes operation. The optical characteristic is measured by using the method of fig.6 and fig.7 under the condition of the darkroom or equivalent to it.

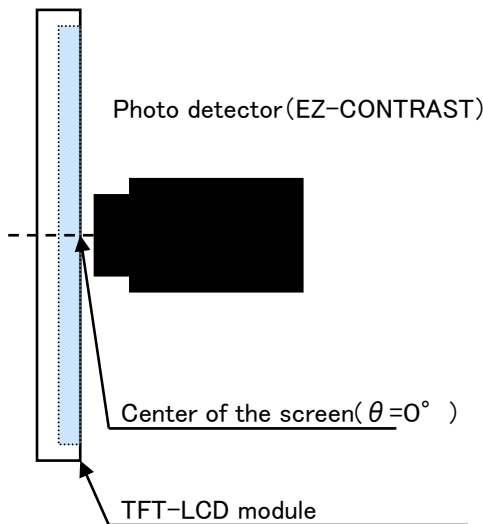

Fig. 6 The way of measuring Viewing angle range/ Response time

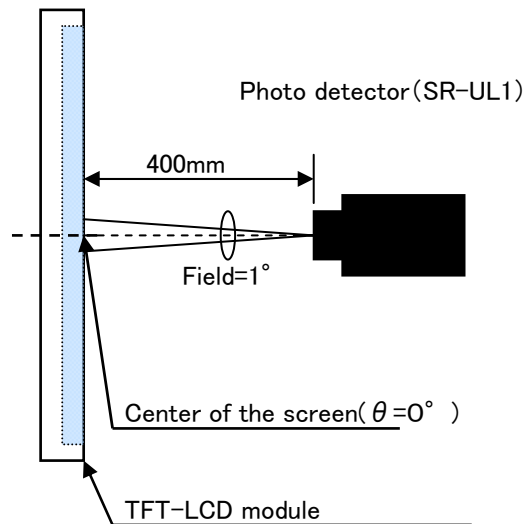
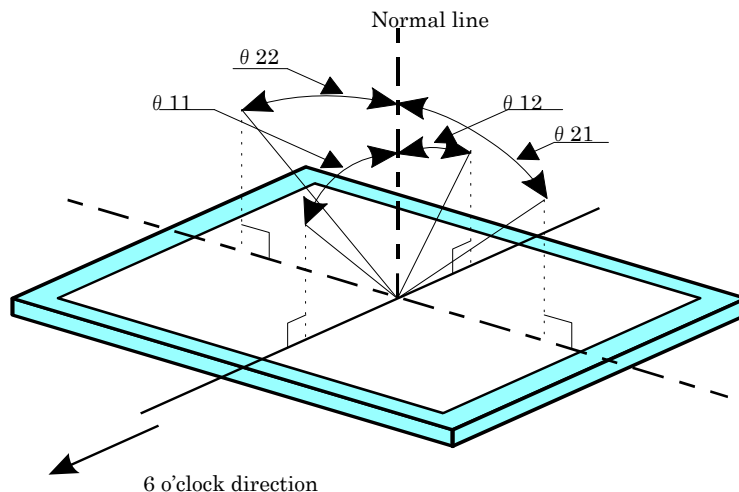

Fig. 7 The way of measuring Luminance/ Chromaticity/ Contrast

[Note9-1] Viewing angle range is defined as follows.



[Note9-2] Contrast ratio of transmission is defined as follows:

$$\text{Contrast ratio (CR)} = \frac{\text{Photo detector output with LCD being "white"}}{\text{Photo detector output with LCD being "black"}}$$

[Note9-3] Response time is obtained by measuring the transition time of photo detector output, when input signals are applied so as to make the area "black" to and from "white".

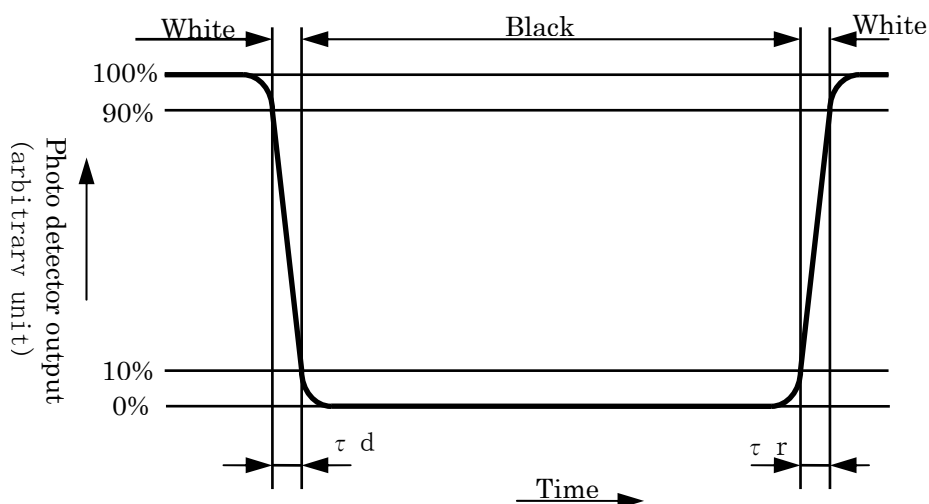

[Note9-4] LED life time is defined as the time when the brightness of the panel is not become less than 50% of the original value in the continuous operation under the condition of LED current  $I_f = 70 \text{ mArms}$  and PWM dimming 100%~5% ( $T_a = 25^\circ\text{C}$ ).

[Note9-5]  $u=Y_{min}/Y_{max}$ :( 9points luminance)

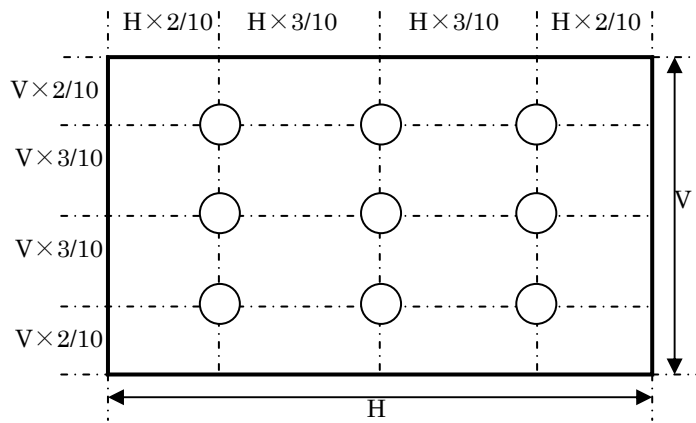

[Note 9-6] The tolerance of color chromaticity of white is shown as follows

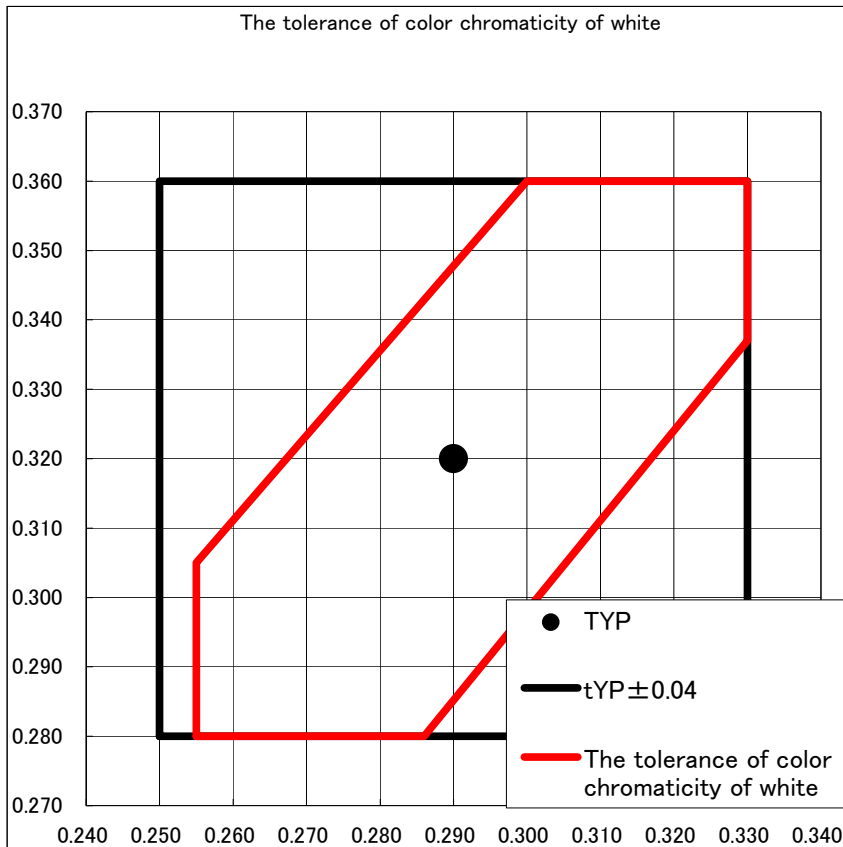

**10. Display quality**

The display quality of the module shall be in compliance with the Incoming Inspection Standards.  
Please reference document number LDI-080DZ03.

**11. Mechanical characteristics**

## 11-1 External appearance

No extreme defect exists. (See Fig. 1)

## 11-2 LCD Panel toughness

The LCD panel shall not be broken ,when 19N is pressed on the center of the panel by a smooth sphere having 15 mm diameter.

Caution: In spite of very soft toughness, if, in the long-term, add pressure on the active area, it is possible to occur the functional damage.

**12. Handling instructions**

## 12-1 Mounting of module

The TFT-LCD module is designed to be mounted on equipment using the mounting tabs in the four corners of the module at the rear side.

On mounting the module, as the 2.5 tapping screw (fastening torque is TYP 0.3N·m(design target)) is recommended, be sure to fix the module on the same plane, taking care not to wrap or twist the module.

Don't reach the pressure of touch-switches of the set side to a module directly, because images may be disturbed.

Power off the module when you connect the input/output connector.

Please ensure that the LCD metal case is grounded in the system design.

## 12-2 Precautions in mounting

Polarizer which is made of soft material and susceptible to flaw must be handled carefully.

Protection sheet is applied on the surface to protect it against scratches and dirties.

It is recommended to remove the protection sheet immediately before the use, taking care of static electricity.

Precautions in removing the protection sheet

## A) Working environment

When the protection sheet is removed off, static electricity may cause dust to stick to the polarizer surface.

To avoid this, the following working environment is desirable.

a) Floor: Conductive treatment of 1M $\Omega$  or more on the tile  
(conductive mat or conductive paint on the tile)

b) Clean room free from dust and with an adhesive mat on the doorway

c) Advisable humidity:50%~70%                      Advisable temperature:15°C~27°C

d) Workers shall wear conductive shoes, conductive work clothes, conductive gloves and an earth band.

## B) Working procedures

- a) Direct the wind of discharging blower somewhat downward to ensure that module is blown sufficiently. Keep the distance between module and discharging blower within 20 cm.
- b) Attach adhesive tape to the protection sheet part near discharging blower so as to protect polarizer against flaw.
- c) Remove the protection sheet, pulling adhesive tape slowly to your side.
- d) On removing the protection sheet, pass the module to the next work process to prevent the module to get dust.

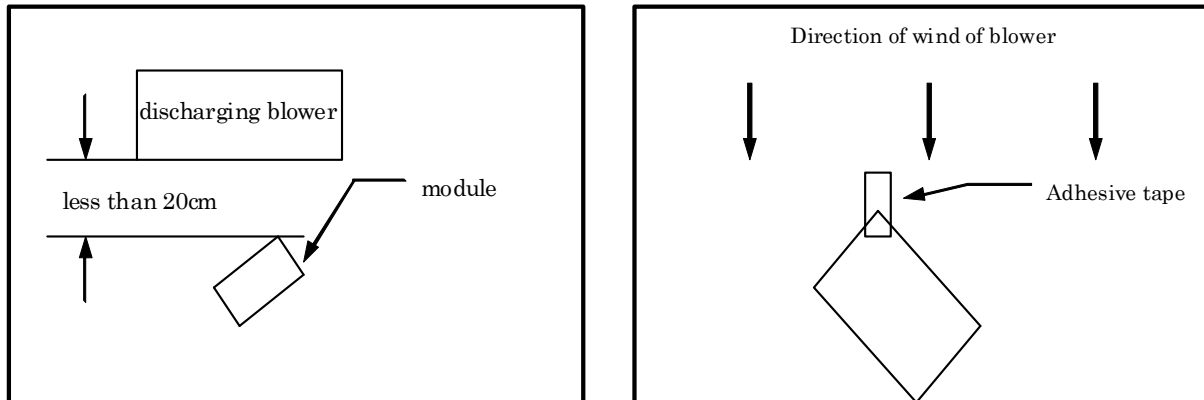

## e) Method of removing dust from polarizer

- Blow off dust with N<sub>2</sub> blower for which static electricity preventive measure has been taken.
- Since polarizer is vulnerable, wiping should be avoided.  
But when the panel has stain or grease, to use adhesive tape is recommended to remove them softly from the panel.

When metal part of the TFT-LCD module (shielding lid and rear case) is soiled, wipe it with soft dry cloth. For stubborn dirties, wipe the part, breathing on it. Wipe off water drop or finger grease immediately. Long contact with water may cause discoloration or spots. TFT-LCD module uses glass which breaks or cracks easily if dropped or bumped on hard surface. Handle with care. Since CMOS LSI is used in this module, take care of static electricity and earth your body when handling.

## 12-3 Caution of product design

Please follow the below items strictly when the product is designed by using this module.

- The LCD module shall be protected against water or salt-water by the waterproof cover.
- Please take measures to interferential radiation from the module not to interfere surrounding appliances.
- Because driving voltage for backlight is high, it is dangerous to use LCD module under the conditions which are deviated from specification.
- The equipment for which the LCD module is used shall have fail-safe design so that the safety can be ensured in case abnormality of inverter circuit, etc. should occur.

## 12-5) Others

1. Liquid crystal is sensitive to ultraviolet rays. Do not expose the module to direct sunlight for a long time.
2. Storage of the module under temperatures lower than the specified range may solidify liquid crystal in the module, resulting in damage to the panel. Storage of the module under temperatures exceeding the specified range may cause an irreversible change of liquid crystal to the isotropic phase.
3. When the LCD is broken, take care not to mouth liquid crystal. When liquid crystal adheres to skin or clothes, wash it off immediately with soap and water.
4. Remove any water droplets or dirt on the polarizer without delay.  
Failure to do so may cause degradation.
5. Observe all other precautionary requirements in handling general electronic components.
6. When it keeps pushing a part of the touch panel for a long time, it causes the generation of Newton rings.
7. The LCD has been calibrated prior to shipment,  
do not change any of the adjustable values within the LCD module.







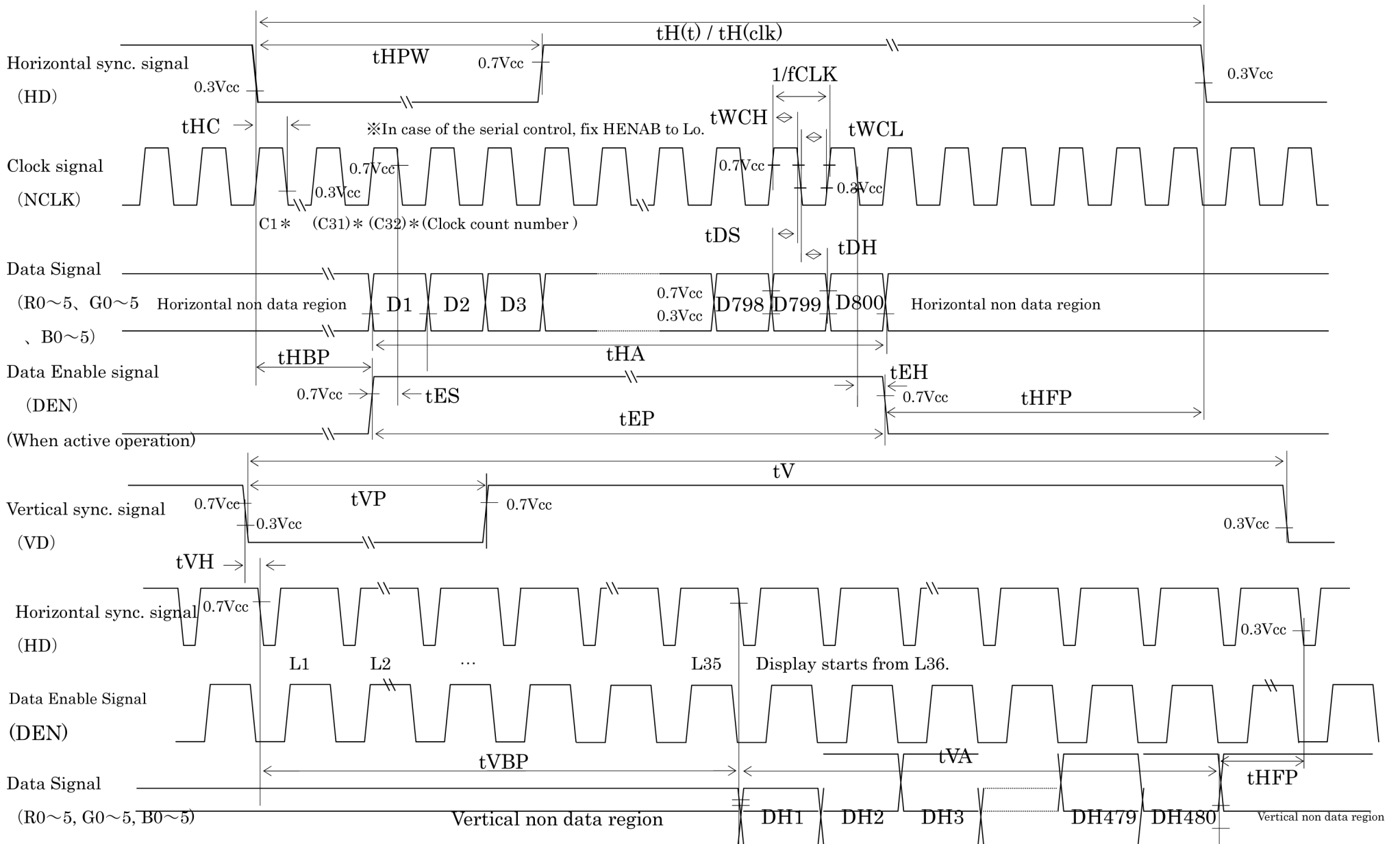

Fig. 2: Input signal timing chart

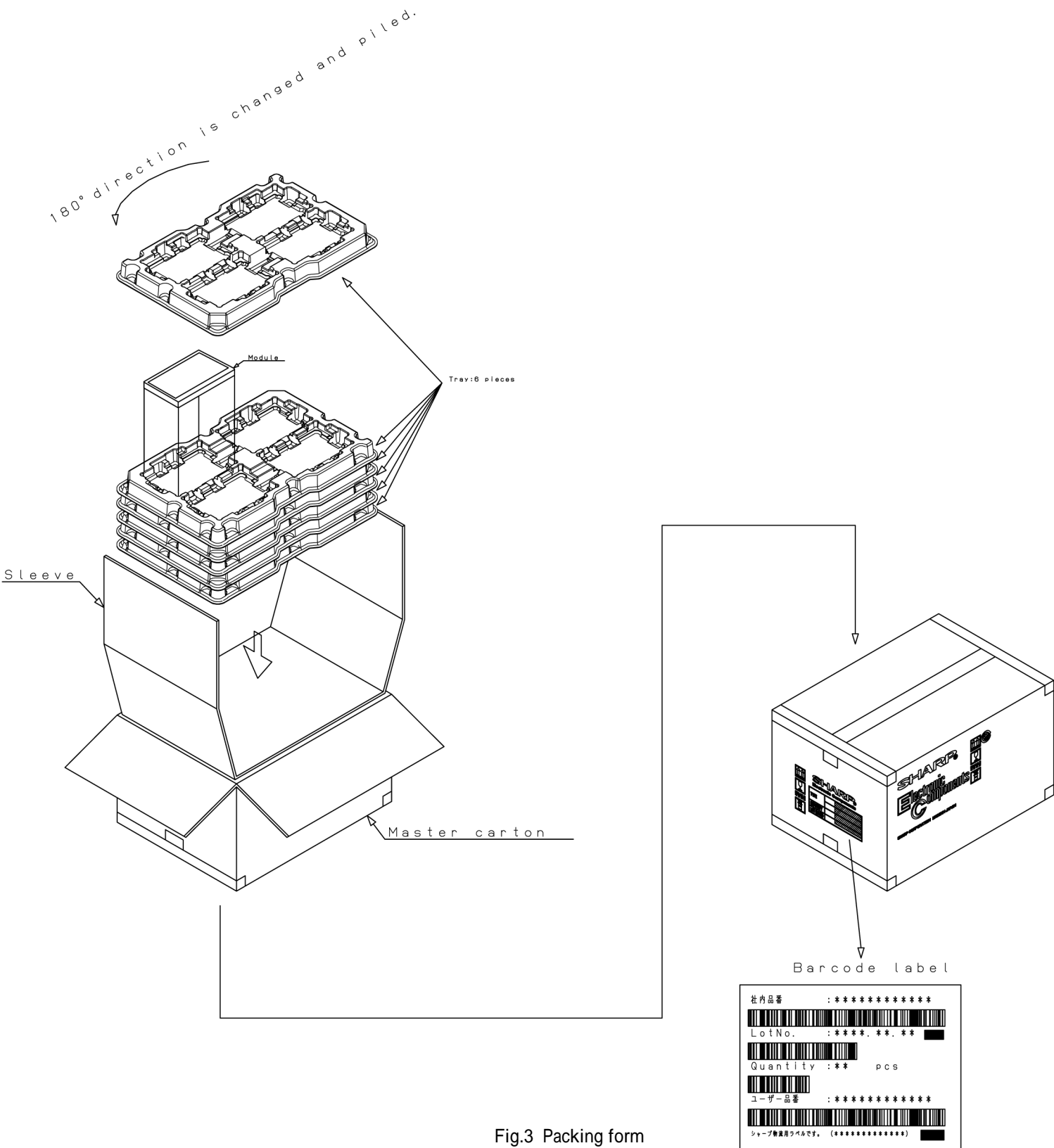

Fig.3 Packing form

Fig.3 Packing form

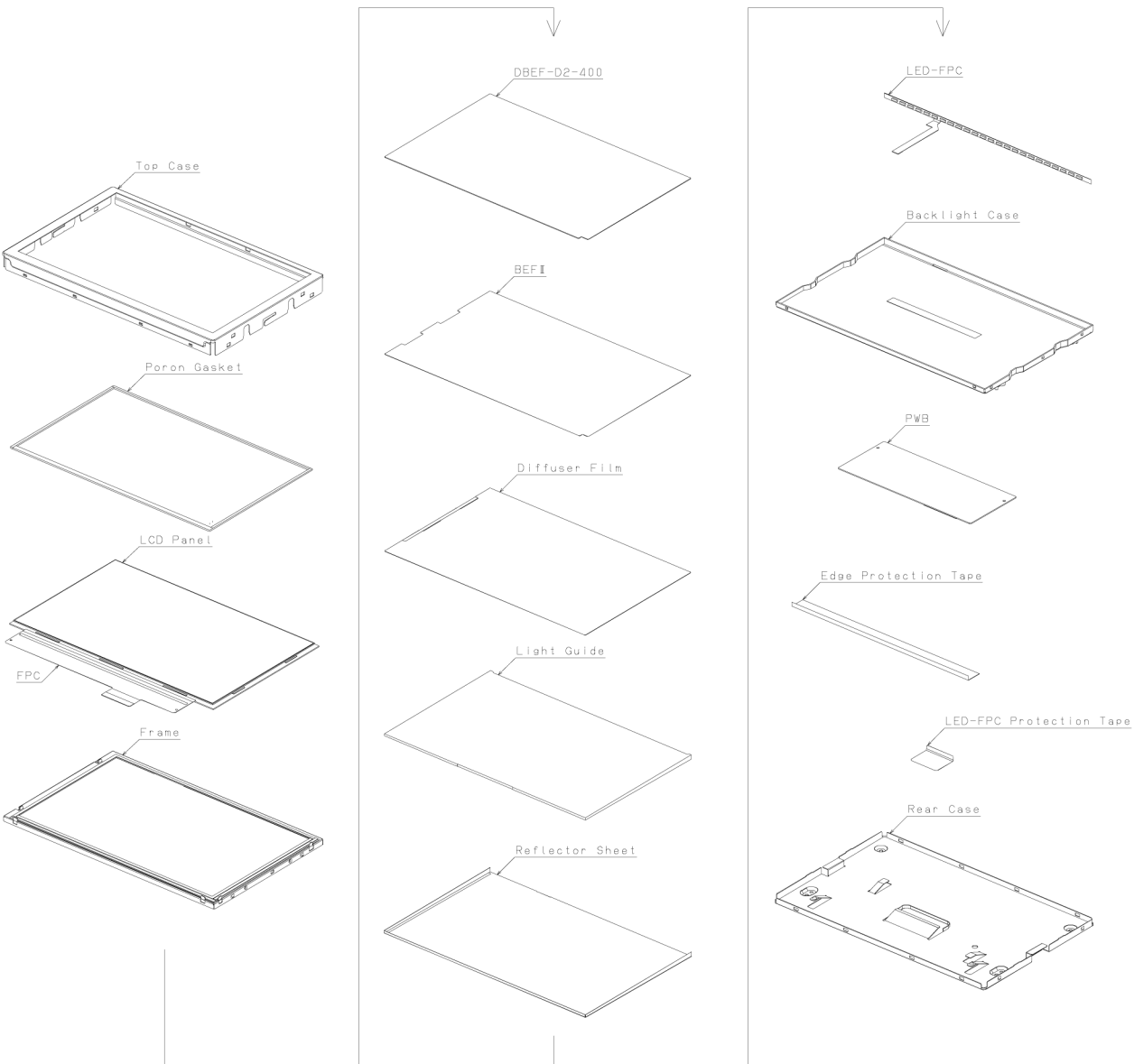

Fig.4 Construction of LQ080Y5DZ03