

New Generation of WICOP

High-Power LED – WICOP-19

S1W0-1919xxx03-0000000-00001
(Cool, Neutral, Warm)



Product Brief

Description

- The WICOP series is designed for high flux output applications with high current operation capability.
- Compact footprint(1.81x1.81mm) enables system level cost saving
- It incorporates state of the art SMD design and low thermal resistant material.
- The WICOP is ideal light sources for directional lighting applications such as Spot Lights, various outdoor applications, automotive lightings and high performance torches .

Features and Benefits

- Designed for high current operation
- Low Thermal Resistance
- A wide CCT range of 2,600~7,000K
- ANSI compliant Binning
- RoHS compliant
- Phosphor film directly attached to chip surface

Key Applications

- Residential - Replacement lamps
- Commercial/Industrial – Retail Display
- Outdoor area - Flood/Street light, High Bay

Table 1-1. Product Selection Table

Reference Code	Color	Nominal CCT	Part Number	CRI
				Min
SZ8-Y19-W0-C7	Cool White	6500K	S1W0-1919657003-0000000-00001	70
		5700K	S1W0-1919577003-0000000-00001	
		5000K	S1W0-1919507003-0000000-00001	
SZ8-Y19-WN-C7	Neutral White	4500K	S1W0-1919457003-0000000-00001	
		4000K	S1W0-1919407003-0000000-00001	
SZ8-Y19-WW-C7	Warm White	3500K	S1W0-1919357003-0000000-00001	
		3000K	S1W0-1919307003-0000000-00001	
		2700K	S1W0-1919277003-0000000-00001	



Table 1-2. Product Selection Table

Reference Code	Color	Nominal CCT	Part Number	CRI
				Min
SZ8-Y19-W0-C8	Cool White	6500K	S1W0-1919658003-00000000-00001	80
		5700K	S1W0-1919578003-00000000-00001	
		5000K	S1W0-1919508003-00000000-00001	
SZ8-Y19-WN-C8	Neutral White	4500K	S1W0-1919458003-00000000-00001	
		4000K	S1W0-1919408003-00000000-00001	
SZ8-Y19-WW-C8	Warm White	3500K	S1W0-1919358003-00000000-00001	
		3000K	S1W0-1919308003-00000000-00001	
		2700K	S1W0-1919278003-00000000-00001	
SZ8-Y19-W0-C9	Cool White	6500K	S1W0-1919659003-00000000-00001	
		5700K	S1W0-1919579003-00000000-00001	
		5000K	S1W0-1919509003-00000000-00001	
SZ8-Y19-WN-C9	Neutral White	4500K	S1W0-1919459003-00000000-00001	
		4000K	S1W0-1919409003-00000000-00001	
SZ8-Y19-WW-C9	Warm White	3500K	S1W0-1919359003-00000000-00001	
		3000K	S1W0-1919309003-00000000-00001	
		2700K	S1W0-1919279003-00000000-00001	

Table of Contents

Index	
• Product Brief	1
• Table of Contents	3
• Performance Characteristics	4
• Characteristics Graph	6
• Color bin structure	11
• Mechanical Dimensions	16
• Material Structure	17
• Reflow Soldering Characteristics	18
• Emitter Tape & Reel Packaging	19
• Product Nomenclature	21
• Handling of Silicone Resin for LED	22
• Precaution For Use	23
• Company Information	26

Performance Characteristics

Table 2. Electro Optical Characteristics, $I_F = 700\text{mA}$, $T_j=85^\circ\text{C}$

Min. CRI, $R_a^{[4]}$	Nominal CCT [K] ^[1]	Min. Flux [lm]	Typ. Luminous Flux $\Phi_v^{[3]}$ [lm]			Typ. Luminous Efficacy [lm/W] @700mA	Part Number
			700mA	1000mA	1500mA		
70	6500	271	289	381	517	144	S1W0-1919657003-00000000-00001
	5700	271	292	385	522	146	S1W0-1919577003-00000000-00001
	5000	285	299	394	535	149	S1W0-1919507003-00000000-00001
	4000	285	299	394	535	149	S1W0-1919407003-00000000-00001
	3500	271	273	360	488	136	S1W0-1919357003-00000000-00001
	3000	254	267	352	477	133	S1W0-1919307003-00000000-00001
	2700	254	261	344	467	130	S1W0-1919277003-00000000-00001
80	6500	237	262	345	468	131	S1W0-1919658003-00000000-00001
	5700	254	266	351	476	133	S1W0-1919578003-00000000-00001
	5000	254	272	359	486	136	S1W0-1919508003-00000000-00001
	4000	254	272	359	486	136	S1W0-1919408003-00000000-00001
	3500	237	259	341	463	129	S1W0-1919358003-00000000-00001
	3000	237	254	335	454	127	S1W0-1919308003-00000000-00001
	2700	237	249	328	445	124	S1W0-1919278003-00000000-00001
90	6500	208	234	309	418	117	S1W0-1919659003-00000000-00001
	5700	223	237	312	424	118	S1W0-1919579003-00000000-00001
	5000	223	240	316	429	120	S1W0-1919509003-00000000-00001
	4000	208	226	298	404	113	S1W0-1919409003-00000000-00001
	3500	182	203	268	363	101	S1W0-1919359003-00000000-00001
	3000	182	198	261	354	99	S1W0-1919309003-00000000-00001
	2700	172	190	251	340	95	S1W0-1919279003-00000000-00001

Notes :

(1) Correlated Color Temperature is derived from the CIE 1931 Chromaticity diagram.

Color coordinate : ± 0.005 , CCT $\pm 5\%$ tolerance.

(2) Seoul Semiconductor maintains a tolerance of $\pm 7\%$ on flux and power measurements.

(3) Φ_v is the total luminous flux output as measured with an integrating sphere.

(4) Tolerance is ± 2.0 on CRI measurements.

Performance Characteristics

Table 3. Absolute Maximum Ratings

Parameter	Symbol	Value			Unit
		Min.	Typ.	Max.	
Forward Current ^[1]	I_F	-	0.7	1.5 ^[3]	A
Power Dissipation	P_D	-	-	7.8	W
Junction Temperature	T_j	-	-	145	°C
Storage Temperature	T_{stg}	- 40	-	125	°C
Viewing angle	θ		140		degree
Forward voltage (700mA, 85°C)	V_F		2.86	3.25	V
Thermal resistance (J to S) ^[2]	$R\theta_{J-S}$	-	4.5 ^[3]	-	K/W
ESD Sensitivity(HBM)		Class 2 JEDEC JS-001-2017			

Notes :

(1) At Junction Temperature 85°C condition.

(2) $R\theta_{J-S}$ is tested at 700mA.

(3) Using Metal PCB (Normal type).

- Thermal resistance can be increased substantially depending on the heat sink design/operating condition, and the maximum possible driving current will decrease accordingly.

Characteristics Graph

Color Spectrum

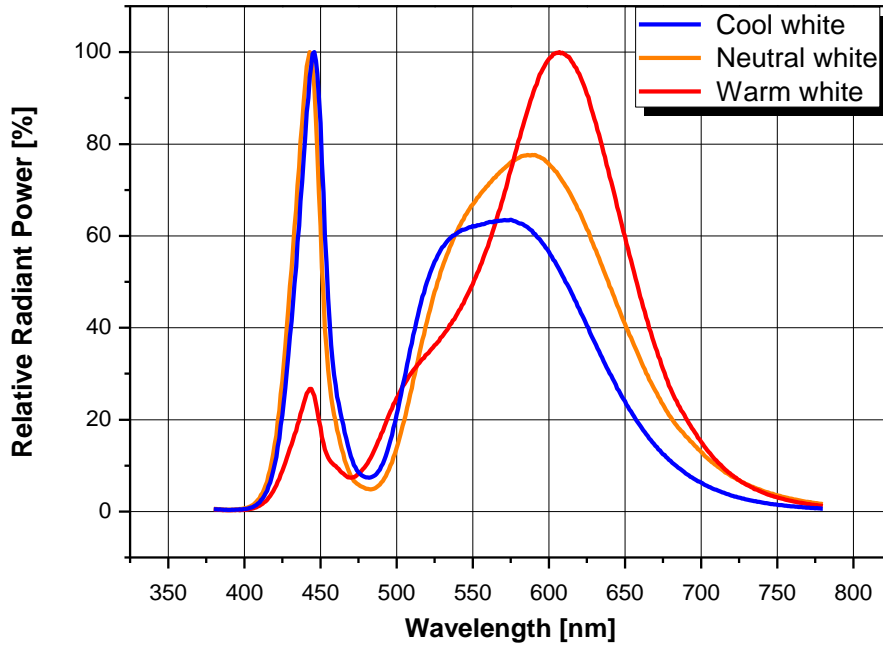

(Fig 1)

Typical Spatial Distribution

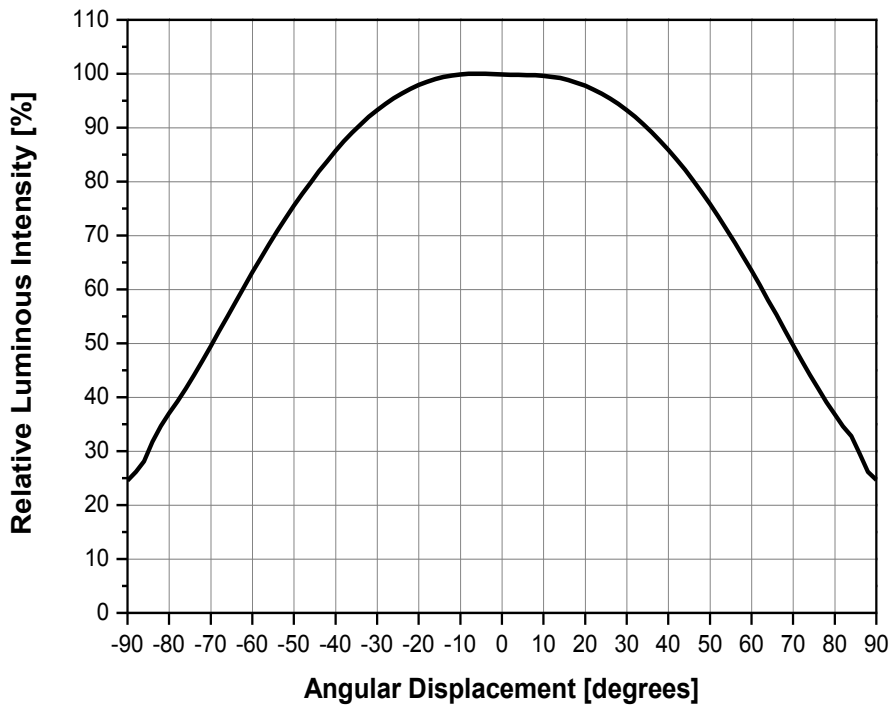

(Fig 2)

Characteristics Graph

Forward Voltage vs. Forward Current, $T_j=85^\circ\text{C}$

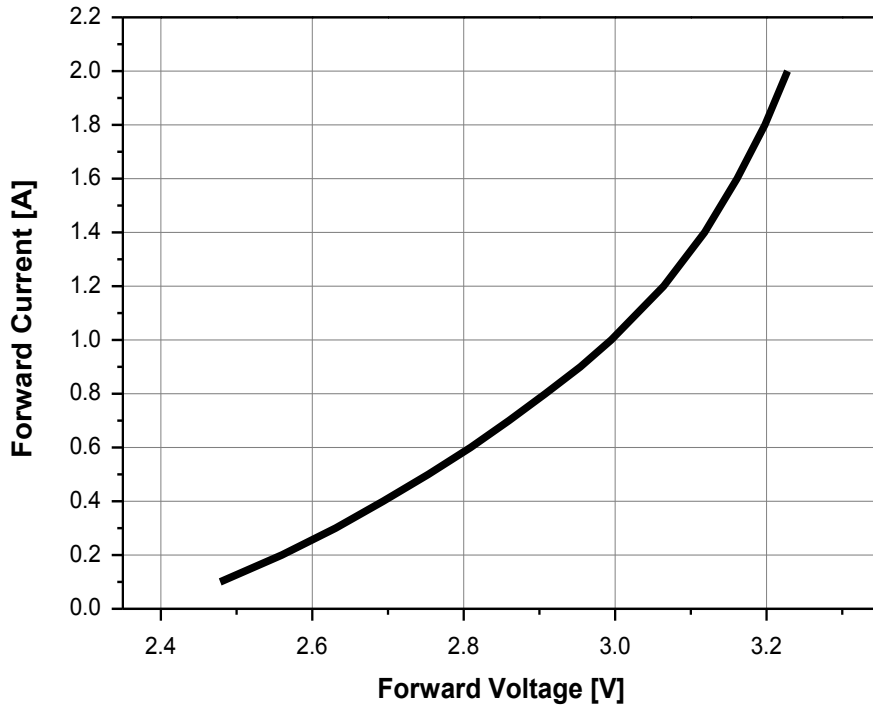

(Fig 3)

Forward Current vs. Relative Luminous Flux, $T_j=85^\circ\text{C}$

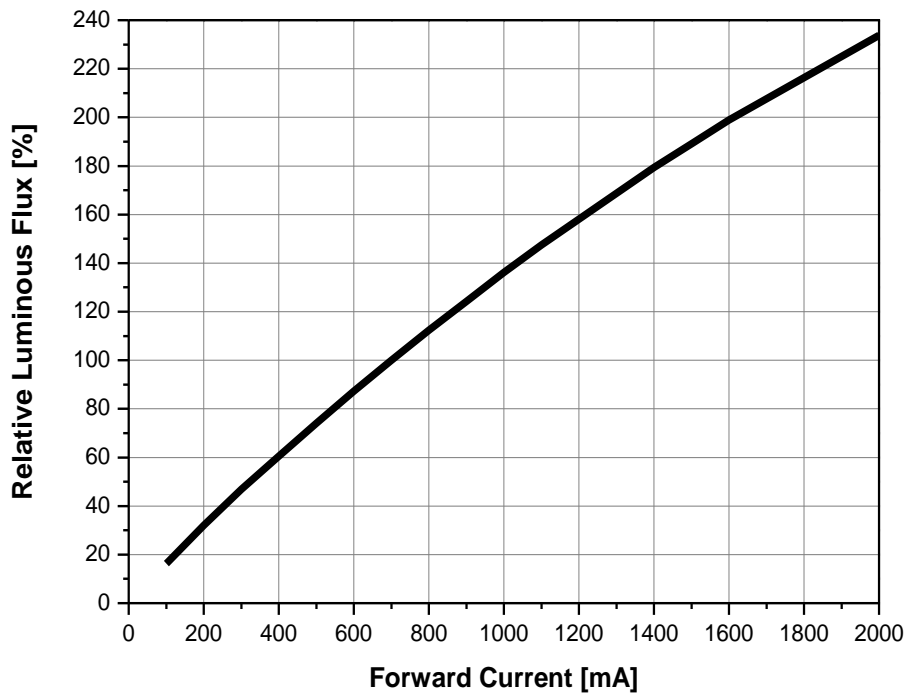

(Fig 4)

Characteristics Graph

Forward Current vs. CIE X, Y Shift, $T_j=85^\circ\text{C}$

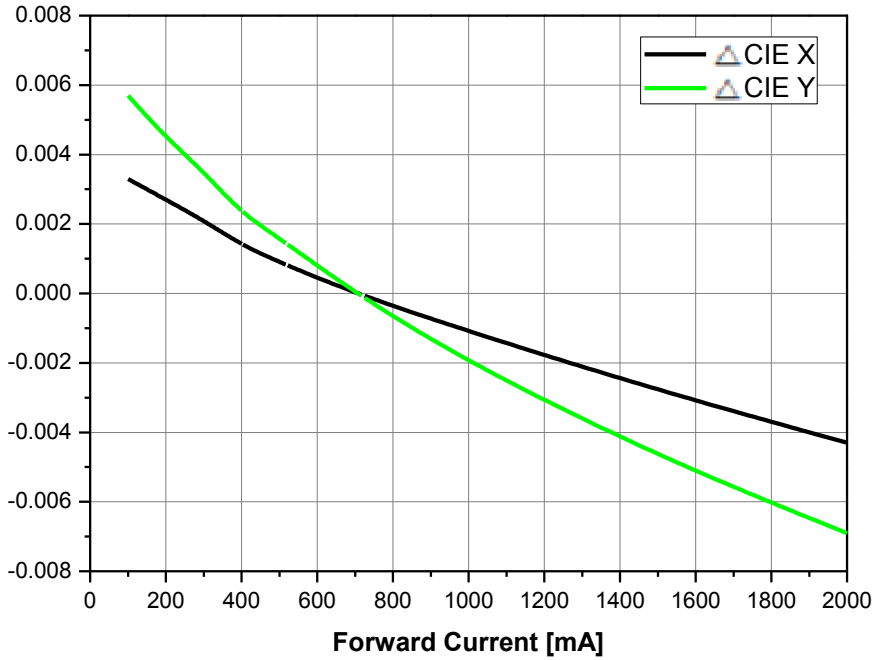

(Fig 5)

Junction Temp. vs. CIE X, Y Shift, $I_f=700\text{mA}$

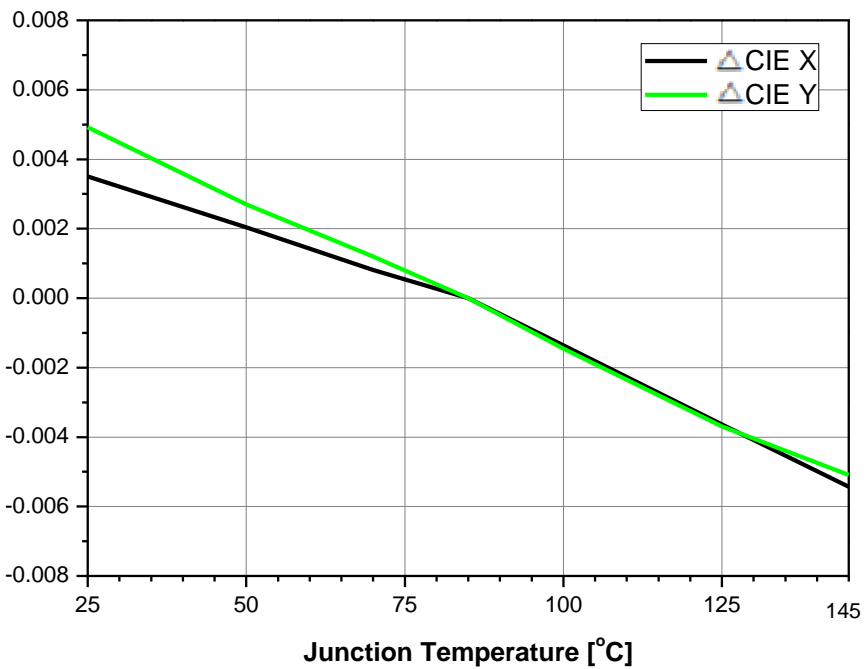

(Fig 6)

Characteristics Graph

Relative Light Output vs. Junction Temperature, $I_F=700\text{mA}$

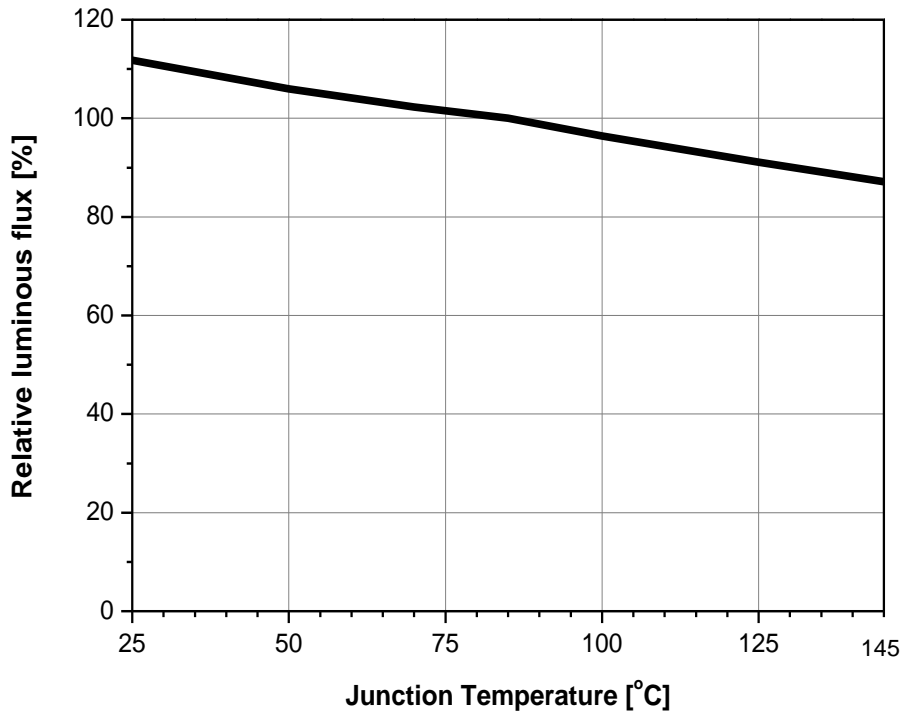

(Fig 7-1)

Relative Forward Voltage vs. Junction Temperature, $I_F=700\text{mA}$

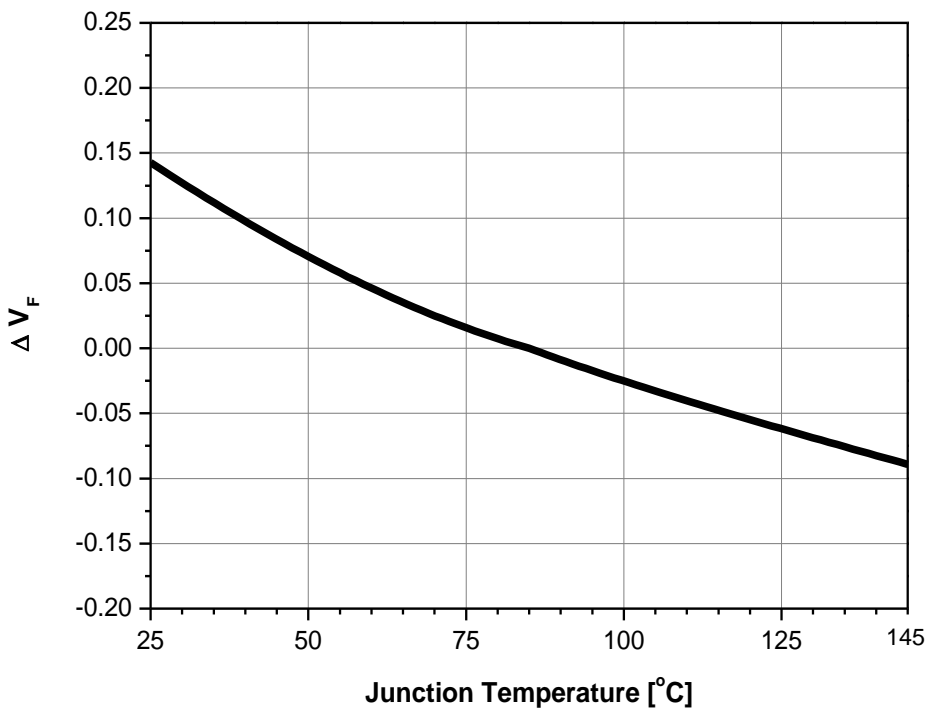

(Fig 7-2)

Characteristics Graph

Maximum Forward Current vs. Ambient Temperature, $T_j(\text{max.})=145^\circ\text{C}$

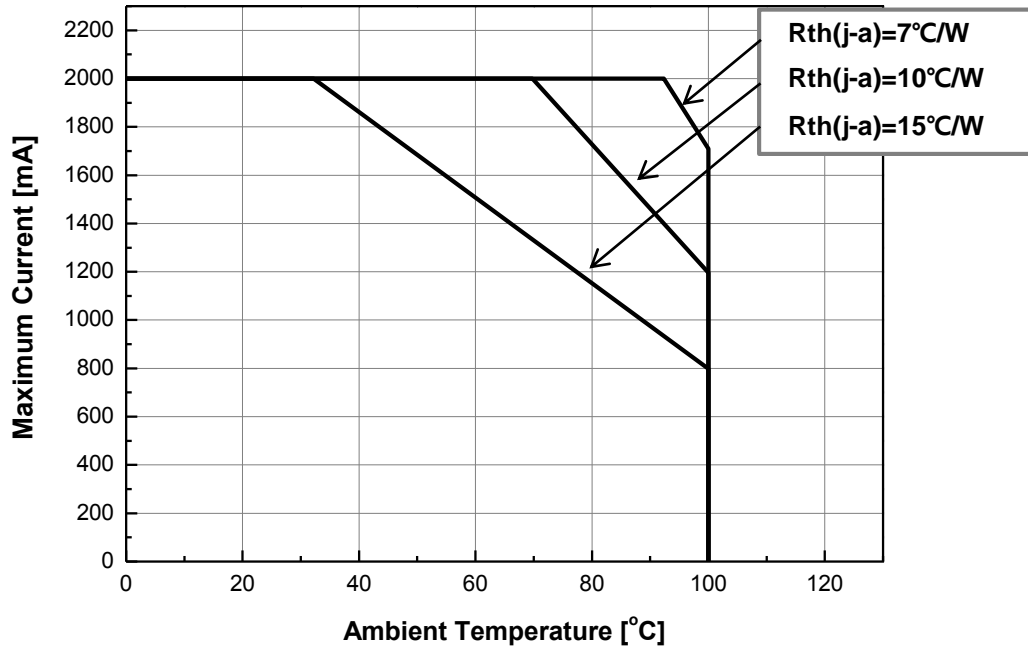

(Fig 9)

Color Bin Structure

Table 4. Bin Code description, $I_F=700\text{mA}$, $T_J=85^\circ\text{C}$
<CRI 70>

Part Number	Luminous Flux [lm]			Color Chromaticity Coordinate	Typical Forward Voltage [V_F] ⁽¹⁾		
	Bin Code	Min.	Max.		Bin Code	Min.	Max.
S1W0-1919xx7003-00000000-00001	V3	223	237	Refer to page. 13~15	G	2.75	3.00
	W1	237	254				
	W2	254	271				
	W3	271	285		H	3.00	3.25
	W4	285	299				
	W5	299	313				

<CRI 80>

Part Number	Luminous Flux [lm]			Color Chromaticity Coordinate	Typical Forward Voltage [V_F] ⁽¹⁾		
	Bin Code	Min.	Max.		Bin Code	Min.	Max.
S1W0-1919xx8003-00000000-00001	V3	223	237	Refer to page. 13~15	G	2.75	3.00
	W1	237	254				
	W2	254	271				
	W3	271	285		H	3.00	3.25
	W4	285	299				
	W5	299	313				

<CRI 90>

Part Number	Luminous Flux [lm]			Color Chromaticity Coordinate	Typical Forward Voltage [V_F] ⁽¹⁾		
	Bin Code	Min.	Max.		Bin Code	Min.	Max.
S1W0-1919xx9003-00000000-00001	U2	172	182	Refer to page. 13~15	G	2.75	3.00
	U3	182	195				
	V1	195	208				
	V2	208	223		H	3.00	3.25
	V3	223	237				
	W1	237	254				

Notes :

(1) Tolerance is $\pm 0.06\text{V}$ on forward voltage measurements.

Color Bin Structure

Table 5. Luminous Flux rank distribution (CRI70)

Available Rank

<CRI70>

CCT	CIE	Luminous Flux Rank						
6,000 ~ 7,000K	A	V2	V3	W1	W2	W3	W4	W5
5,300 ~ 6,000K	B	V2	V3	W1	W2	W3	W4	W5
4,700 ~ 5,300K	C	V2	V3	W1	W2	W3	W4	W5
4,200 ~ 4,700K	D	V2	V3	W1	W2	W3	W4	W5
3,700 ~ 4,200K	E	V2	V3	W1	W2	W3	W4	W5
3,200 ~ 3,700K	F	V2	V3	W1	W2	W3	W4	W5
2,900 ~ 3,200K	G	V2	V3	W1	W2	W3	W4	W5
2,600 ~ 2,900K	H	V2	V3	W1	W2	W3	W4	W5

<CRI80>

CCT	CIE	Luminous Flux Rank						
6,000 ~ 7,000K	A	V2	V3	W1	W2	W3	W4	W5
5,300 ~ 6,000K	B	V2	V3	W1	W2	W3	W4	W5
4,700 ~ 5,300K	C	V2	V3	W1	W2	W3	W4	W5
4,200 ~ 4,700K	D	V2	V3	W1	W2	W3	W4	W5
3,700 ~ 4,200K	E	V2	V3	W1	W2	W3	W4	W5
3,200 ~ 3,700K	F	V2	V3	W1	W2	W3	W4	W5
2,900 ~ 3,200K	G	V2	V3	W1	W2	W3	W4	W5
2,600 ~ 2,900K	H	V2	V3	W1	W2	W3	W4	W5

<CRI90>

CCT	CIE	Luminous Flux Rank						
6,000 ~ 7,000K	A	U2	U3	V1	V2	V3	W1	W2
5,300 ~ 6,000K	B	U2	U3	V1	V2	V3	W1	W2
4,700 ~ 5,300K	C	U2	U3	V1	V2	V3	W1	W2
4,200 ~ 4,700K	D	U2	U3	V1	V2	V3	W1	W2
3,700 ~ 4,200K	E	U2	U3	V1	V2	V3	W1	W2
3,200 ~ 3,700K	F	U2	U3	V1	V2	V3	W1	W2
2,900 ~ 3,200K	G	U2	U3	V1	V2	V3	W1	W2
2,600 ~ 2,900K	H	U2	U3	V1	V2	V3	W1	W2

Notes :

(1) Tolerance is $\pm 0.06V$ on forward voltage measurements.

Color Bin Structure

CIE Chromaticity Diagram, $T_j=85^\circ\text{C}$, $I_f=700\text{mA}$

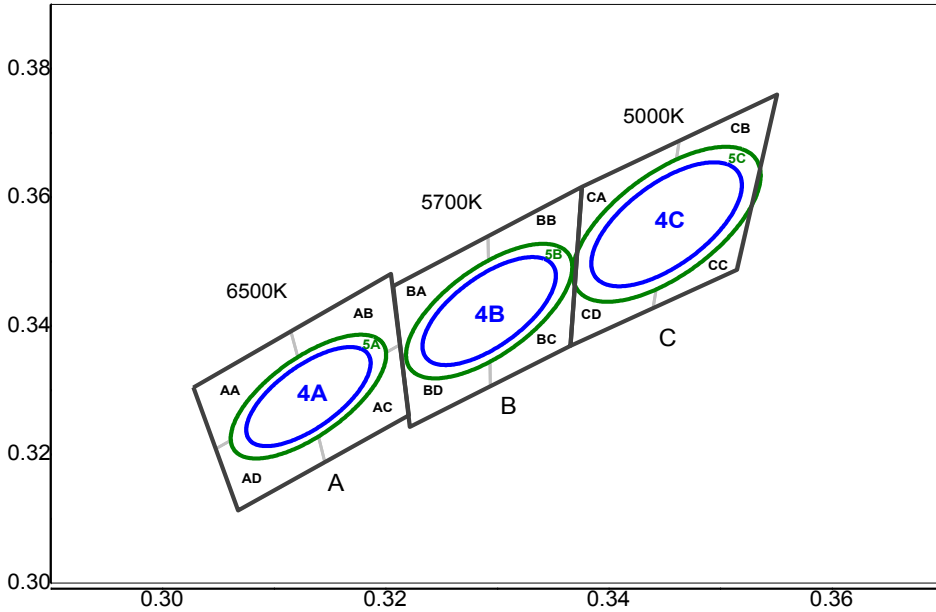

6500K 4Step		5700K 4Step		5000K 4Step	
4A		4B		4C	
Center point	0.3123 : 0.3282	Center point	0.3287 : 0.3417	Center point	0.3447 : 0.3553
Major Axis a	0.0088	Major Axis a	0.0095	Major Axis a	0.0108
Minor Axis b	0.0036	Minor Axis b	0.0040	Minor Axis b	0.0047
Ellipse Rotation Angle	58	Ellipse Rotation Angle	59	Ellipse Rotation Angle	60

6500K 5Step		5700K 5Step		5000K 5Step	
5A		5B		5C	
Center point	0.3123 : 0.3282	Center point	0.3287 : 0.3417	Center point	0.3447 : 0.3553
Major Axis a	0.0110	Major Axis a	0.0118	Major Axis a	0.0135
Minor Axis b	0.0045	Minor Axis b	0.0050	Minor Axis b	0.0058
Ellipse Rotation Angle	58	Ellipse Rotation Angle	59	Ellipse Rotation Angle	60

AA		AB		AC		AD	
CIE X	CIE Y	CIE X	CIE Y	CIE X	CIE Y	CIE X	CIE Y
0.3028	0.3304	0.3115	0.3393	0.3131	0.329	0.3048	0.3209
0.3048	0.3209	0.3131	0.329	0.3146	0.3187	0.3068	0.3113
0.3131	0.329	0.3213	0.3371	0.3221	0.3261	0.3146	0.3187
0.3115	0.3393	0.3205	0.3481	0.3213	0.3371	0.3131	0.329
BA		BB		BC		BD	
CIE X	CIE Y	CIE X	CIE Y	CIE X	CIE Y	CIE X	CIE Y
0.3207	0.3462	0.3292	0.3539	0.3293	0.3423	0.3215	0.3353
0.3215	0.3353	0.3293	0.3423	0.3294	0.3306	0.3222	0.3243
0.3293	0.3423	0.3371	0.3493	0.3366	0.3369	0.3294	0.3306
0.3292	0.3539	0.3376	0.3616	0.3371	0.3493	0.3293	0.3423
CA		CB		CC		CD	
CIE X	CIE Y	CIE X	CIE Y	CIE X	CIE Y	CIE X	CIE Y
0.3376	0.3616	0.3463	0.3687	0.3452	0.3558	0.3371	0.3493
0.3371	0.3493	0.3452	0.3558	0.344	0.3428	0.3366	0.3369
0.3452	0.3558	0.3533	0.3624	0.3514	0.3487	0.344	0.3428
0.3463	0.3687	0.3551	0.376	0.3533	0.3624	0.3452	0.3558

Color Bin Structure

CIE Chromaticity Diagram, $T_j=85^\circ\text{C}$, $I_f=700\text{mA}$

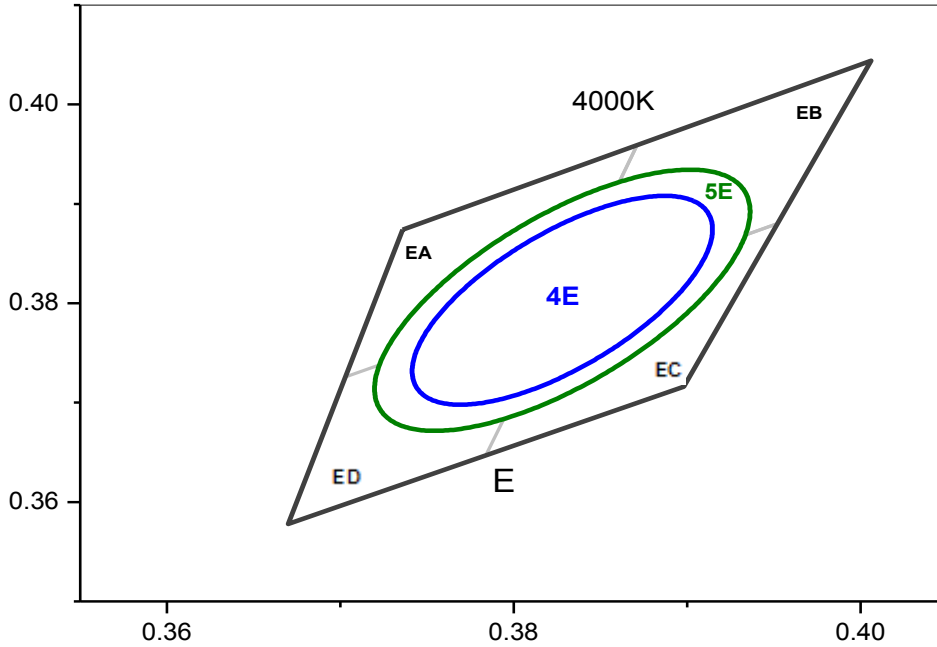

4000K 4Step

4E	
Center point	0.3818 : 0.3797
Major Axis a	0.0125
Minor Axis b	0.0053
Ellipse Rotation Angle	53

4000K 5Step

5E	
Center point	0.3818 : 0.3797
Major Axis a	0.0157
Minor Axis b	0.0067
Ellipse Rotation Angle	53

EA		EB		EC		ED	
CIE X	CIE Y	CIE X	CIE Y	CIE X	CIE Y	CIE X	CIE Y
0.3736	0.3874	0.3871	0.3959	0.3828	0.3803	0.3703	0.3726
0.3703	0.3726	0.3828	0.3803	0.3784	0.3647	0.367	0.3578
0.3828	0.3803	0.3952	0.388	0.3898	0.3716	0.3784	0.3647
0.3871	0.3959	0.4006	0.4044	0.3952	0.388	0.3828	0.3803

Color Bin Structure

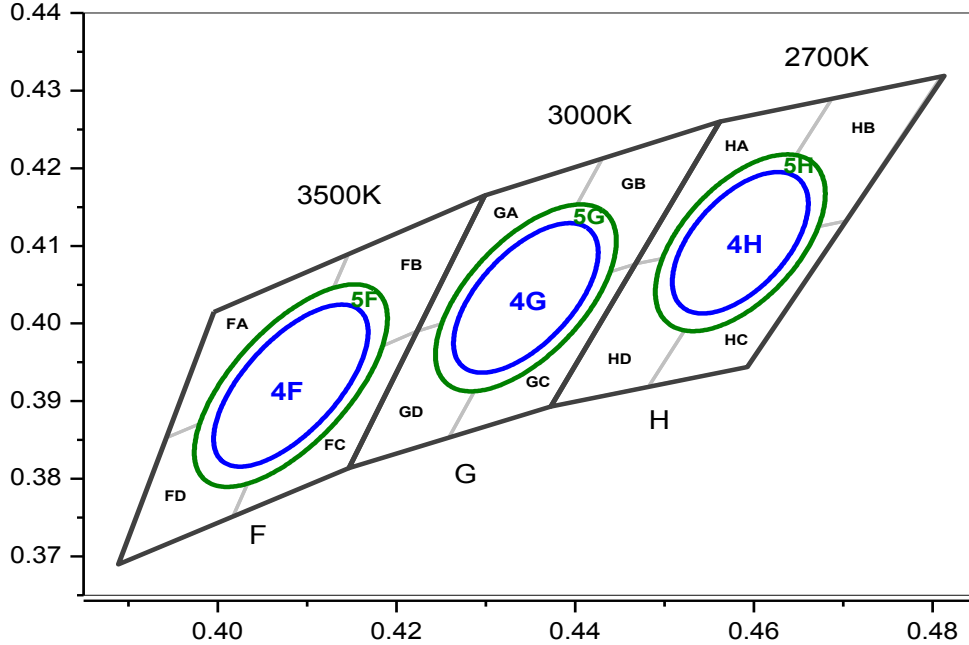
CIE Chromaticity Diagram, $T_j=85^\circ\text{C}$, $I_f=700\text{mA}$

3500K 4Step		3000K 4Step		2700K 4Step	
4F		4G		4H	
Center point	0.4073 : 0.3917	Center point	0.4338 : 0.4030	Center point	0.4578 : 0.4101
Major Axis a	0.0124	Major Axis a	0.0113	Major Axis a	0.0105
Minor Axis b	0.0055	Minor Axis b	0.0055	Minor Axis b	0.0055
Ellipse Rotation Angle	53	Ellipse Rotation Angle	53	Ellipse Rotation Angle	54

3500K 5Step		3000K 5Step		2700K 5Step	
5F		5G		5H	
Center point	0.4073 : 0.3917	Center point	0.4338 : 0.4030	Center point	0.4578 : 0.4101
Major Axis a	0.0155	Major Axis a	0.0142	Major Axis a	0.0132
Minor Axis b	0.0068	Minor Axis b	0.0068	Minor Axis b	0.0068
Ellipse Rotation Angle	53	Ellipse Rotation Angle	53	Ellipse Rotation Angle	54

FA		FB		FC		FD	
CIE X	CIE Y	CIE X	CIE Y	CIE X	CIE Y	CIE X	CIE Y
0.3996	0.4015	0.4146	0.4089	0.4082	0.392	0.3943	0.3853
0.3943	0.3853	0.4082	0.392	0.4017	0.3751	0.3889	0.369
0.4082	0.392	0.4223	0.399	0.4147	0.3814	0.4017	0.3751
0.4146	0.4089	0.4299	0.4165	0.4223	0.399	0.4082	0.392
GA		GB		GC		GD	
CIE X	CIE Y	CIE X	CIE Y	CIE X	CIE Y	CIE X	CIE Y
0.4299	0.4165	0.443	0.4212	0.4345	0.4033	0.4223	0.399
0.4223	0.399	0.4345	0.4033	0.4259	0.3853	0.4147	0.3814
0.4345	0.4033	0.4468	0.4077	0.4373	0.3893	0.4259	0.3853
0.443	0.4212	0.4562	0.426	0.4468	0.4077	0.4345	0.4033
HA		HB		HC		HD	
CIE X	CIE Y	CIE X	CIE Y	CIE X	CIE Y	CIE X	CIE Y
0.4562	0.426	0.4687	0.4289	0.4585	0.4104	0.4468	0.4077
0.4468	0.4077	0.4585	0.4104	0.4483	0.3919	0.4373	0.3893
0.4585	0.4104	0.4703	0.4132	0.4593	0.3944	0.4483	0.3919
0.4687	0.4289	0.481	0.4319	0.4703	0.4132	0.4585	0.4104

Mechanical Dimensions

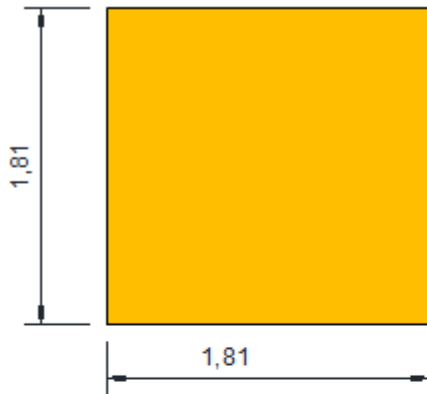

< Top >

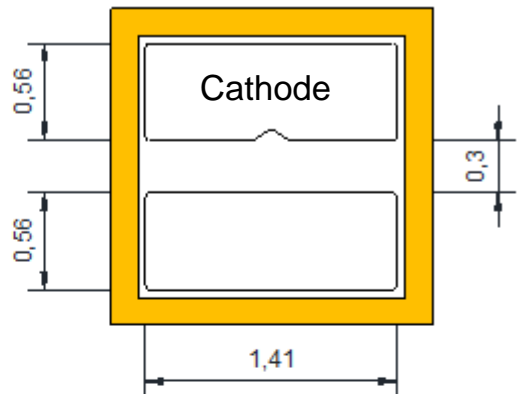

< Bottom >

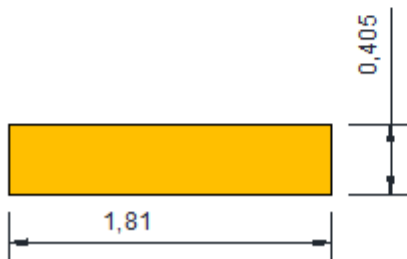

< Side >

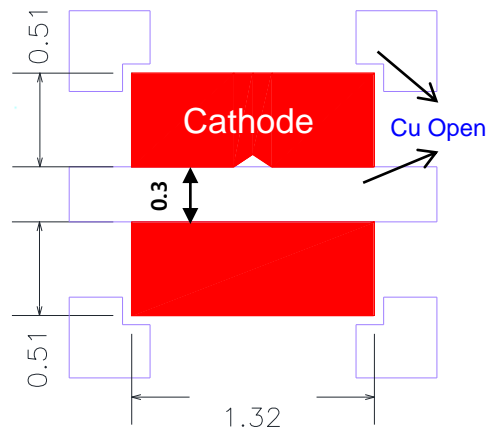

< Recommended Solder Pattern >

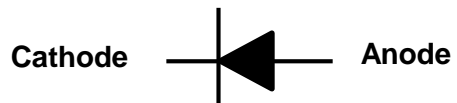

< Inner circuit >

- (1) All dimensions are in millimeters.
- (2) Scale : none
- (3) Undefined tolerance is ± 0.13 mm

Material Structure

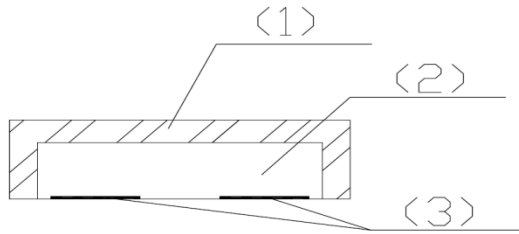

No.	List	Material
①	Encapsulation	Silicone, Phosphor
②	Chip Source	GaN ON SAPPHIRE
③	Solder-PAD	Metal (Au)

Reflow Soldering Characteristics

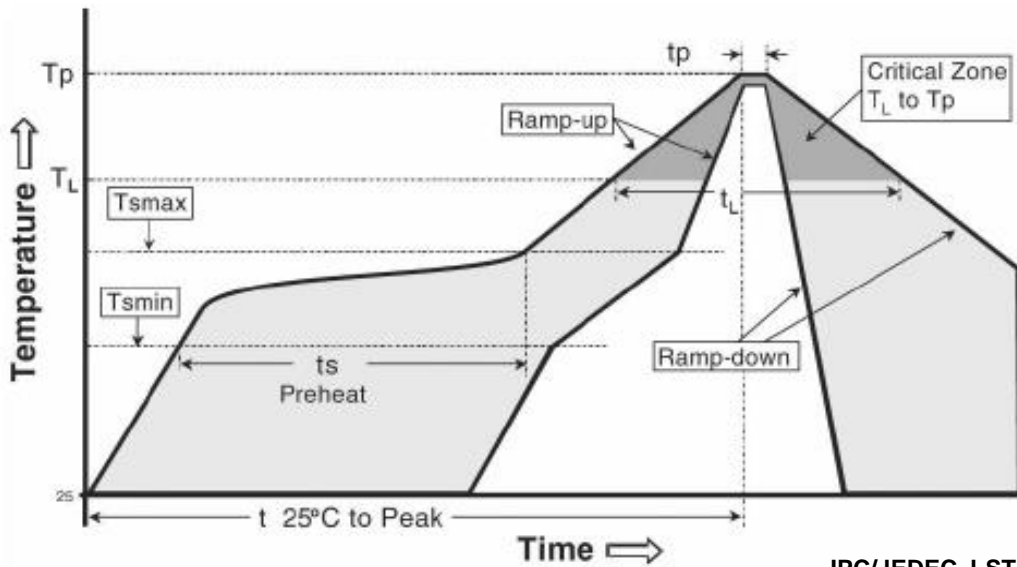
IPC/JEDEC J-STD-020

Profile Feature	Pb-Free Assembly
Average ramp-up rate (T _{smax} to T _p)	3° C/second max.
Preheat - Temperature Min (T _{smin}) - Temperature Max (T _{smax}) - Time (T _{smin} to T _{smax}) (t _s)	150 °C 180 °C 80-120 seconds
Time maintained above: - Temperature (T _L) - Time (t _L)	217~220°C 80-100 seconds
Peak Temperature (T _p)	250~255°C
Time within 5°C of actual Peak Temperature (t _p) ₂	20-40 seconds
Ramp-down Rate	6 °C/second max.
Time 25°C to Peak Temperature	8 minutes max.
Atmosphere	Nitrogen (O ₂ <1000ppm)

Caution

- (1) Reflow soldering is recommended not to be done more than two times. In the case of more than 24 hours passed soldering after first, LED will be damaged.
- (2) Re-soldering should not be done after the LED have been soldered. If re-soldering is unavoidable, LED characteristics should be carefully checked before and after such repair..
- (3) Do not put stress on the LED during heating.
- (4) After reflow, do not clean PCB by water or solvent.

SMT recommendation

- (1) After reflow, Over 80% reflectance of PSR is recommended. → Tamura RPW-8000-xx
- (2) Solder paste materials (SAC 305, No Cleaning Paste) → Senju M705-GRN360-KV
- (3) We recommend Turn On Voltage(TOV) Test 1.8v~2.8v at 1uA (per LED)
- (4) We recommend IR Test 0~1uA at -5V (per LED)

Emitter Tape & Reel Packaging

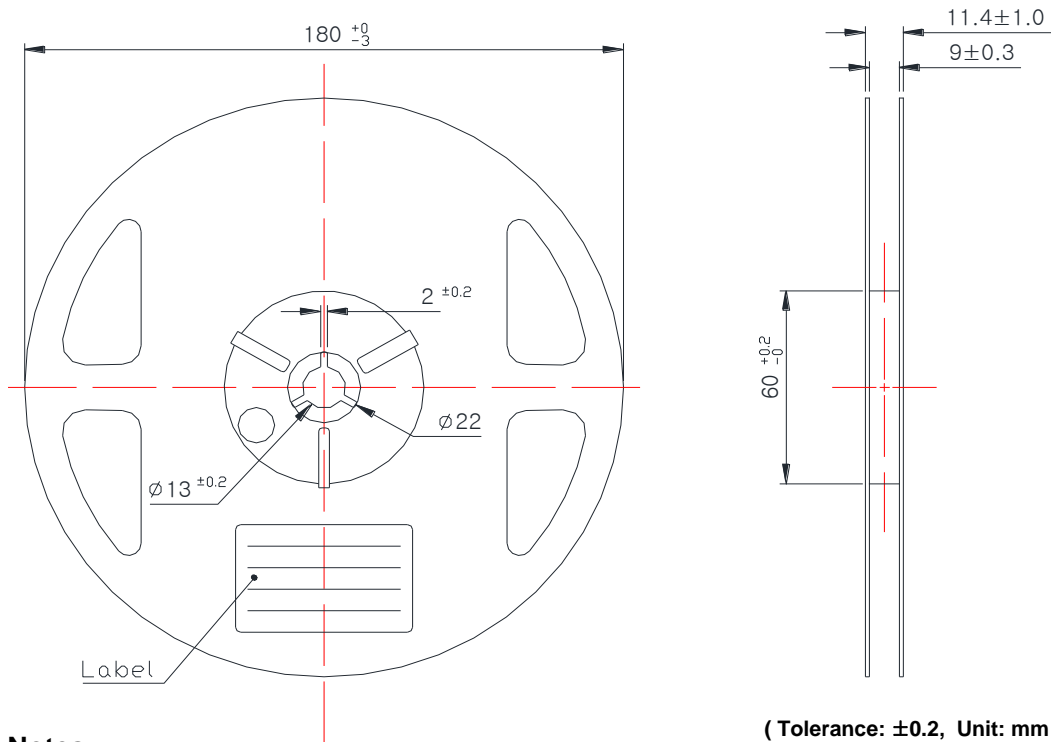
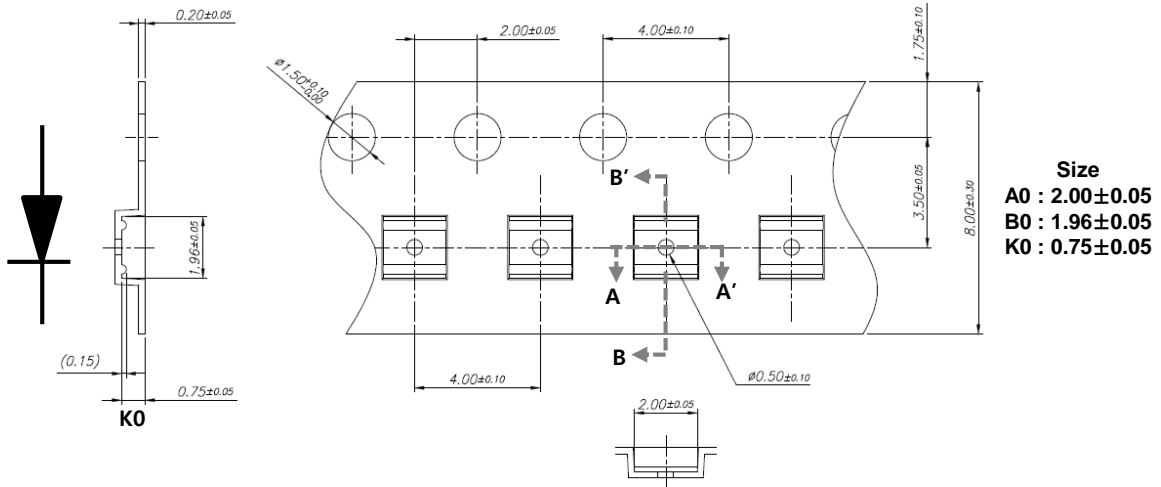
Notes :

- (1) Quantity : 1,500pcs/Reel
(empty slot possible in taping reel)
- (2) Cumulative Tolerance : Cumulative Tolerance/10 pitches to be ±0.2mm
- (3) Adhesion Strength of Cover Tape : Adhesion strength to be 0.1-0.7N when the cover tape is turned off from the carrier tape at the angle of 10° to the carrier tape
- (4) Package : P/N, Manufacturing data Code No. and quantity to be indicated on a damp proof Package

Packaging Information

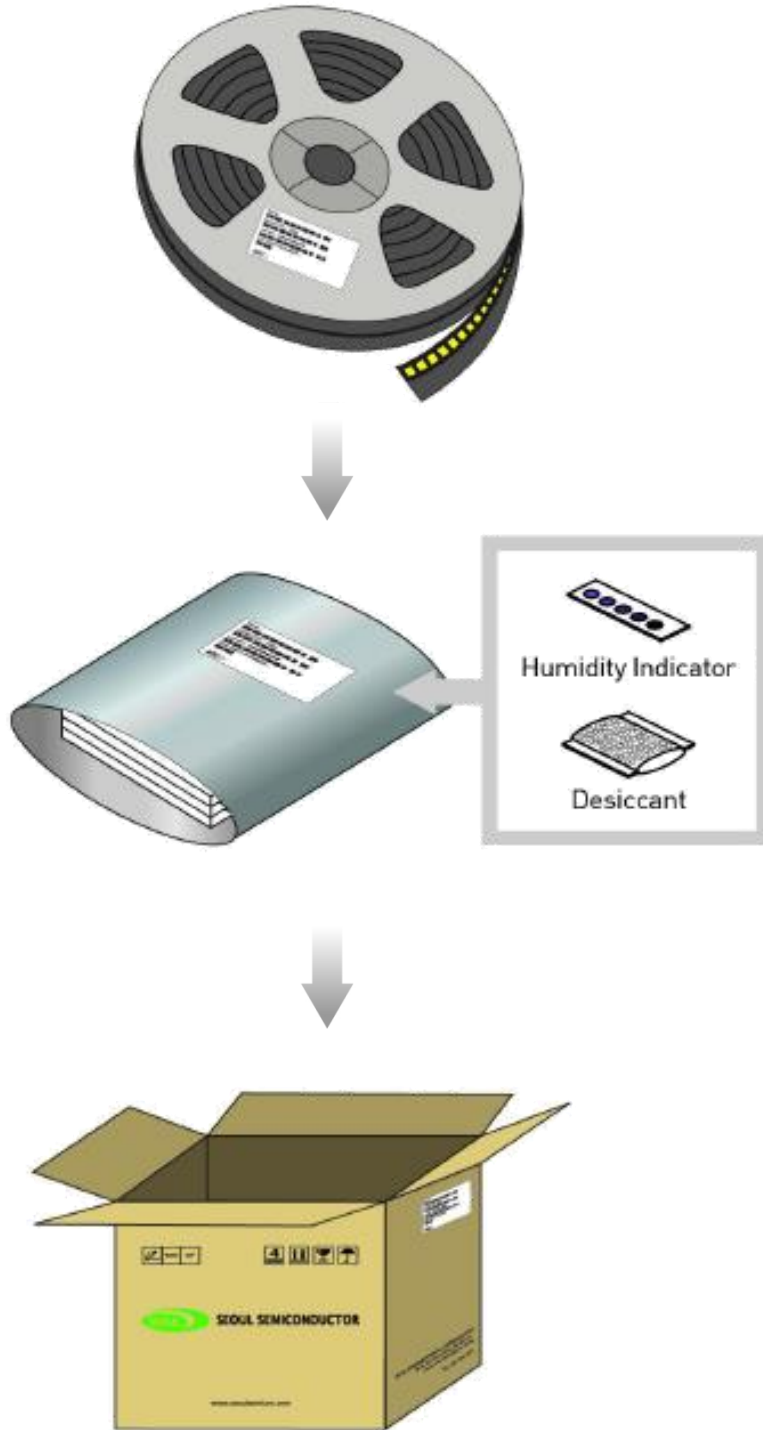

Product Nomenclature

Table 6. Part Numbering System : X₁X₂X₃X₄X₅X₆X₇X₈-X₉

Part Number Code	Description	Part Number	Value
X ₁	Company	S	Seoul Semiconductor
X ₂	Level of Integration	1	Discrete LED
X ₃ X ₄	Technology	W0	General White
X ₅ X ₆ X ₇ X ₈	Dimension	1919	
X ₉ X ₁₀	CCT	40	
X ₁₁ X ₁₂	CRI	70	
X ₁₃ X ₁₄	Vf	03	
X ₁₅ X ₁₆ X ₁₇	Characteristic code Flux Rank	000	
X ₁₈ X ₁₉ X ₂₀	Characteristic code Vf Rank	000	
X ₂₁ X ₂₂	Characteristic code Color Step	00	
X ₂₃ X ₂₄	Type	00	
X ₂₅ X ₂₆ X ₂₇	Internal code	001	

Handling of Silicone Resin for LED

- (1) During processing, mechanical stress on the surface should be minimized as much as possible. Sharp objects of all types should not be used to pierce the sealing compound.



- (2) Do not use tweezers to pick up or handle WICOP LED. A vacuum pick up should only be used.
- (3) When populating boards in SMT production, there are basically no restrictions regarding the form of the pick and place nozzle, except that mechanical pressure on the surface of the resin must be prevented. This is assured by choosing a pick and place nozzle which is smaller than the LED area.
- (4) Silicone differs from materials conventionally used for the manufacturing of LED. These conditions must be considered during the handling of such devices. Compared to standard encapsulants, silicone is generally softer, and the surface is more likely to attract dust. As mentioned previously, the increased sensitivity to dust requires special care during processing.
- (5) Please do not mold this product into another resin (epoxy, urethane, etc) and do not handle this product with acid or sulfur material in sealed space.
- (6) Avoid leaving fingerprints on silicone resin parts.

Precaution for Use

(1) Storage

To avoid the moisture penetration, we recommend storing LED in a dry box with a desiccant. The recommended storage temperature range is 5°C to 30°C and a maximum humidity of RH50%.

(2) Use Precaution after Opening the Packaging

Use proper SMD techniques when the LED is to be soldered dipped as separation of the lens may affect the light output efficiency.

Pay attention to the following:

a. Recommend conditions after opening the package

- Sealing / Temperature : 5 ~ 30°C Humidity : less than RH60%

b. If the package has been opened more than 1 year (**MSL 2**) or the color of the desiccant changes, components should be dried for 10-24hr at 65±5°C

(3) Do not apply mechanical force or excess vibration during the cooling process to normal temperature after soldering.

(4) Do not rapidly cool device after soldering.

(5) Components should not be mounted on warped (non coplanar) portion of PCB.

(6) Radioactive exposure is not considered for the products listed here in.

(7) Gallium arsenide is used in some of the products listed in this publication. These products are dangerous if they are burned or shredded in the process of disposal. It is also dangerous to drink the liquid or inhale the gas generated by such products when chemically disposed of.

(8) This device should not be used in any type of fluid such as water, oil, organic solvent and etc.

(9) When the LED are in operation the maximum current should be decided after measuring the package temperature.

(10) The appearance and specifications of the product may be modified for improvement without notice.

(11) Long time exposure of sunlight or occasional UV exposure will cause lens discoloration.

Precaution for Use

(12) VOCs (Volatile organic compounds) emitted from materials used in the construction of fixtures can penetrate silicone encapsulants of LED and discolor when exposed to heat and photonic energy. The result can be a significant loss of light output from the fixture. Knowledge of the properties of the materials selected to be used in the construction of fixtures can help prevent these issues.

(13) Attaching LED, do not use adhesives that outgas organic vapor.

(14) The driving circuit must be designed to allow forward voltage only when it is ON or OFF. If the reverse voltage is applied to LED, migration can be generated resulting in LED damage.

(15) LED are sensitive to Electro-Static Discharge (ESD) and Electrical Over Stress (EOS). Below is a list of suggestions that Seoul Semiconductor purposes to minimize these effects.

a. ESD (Electro Static Discharge)

Electrostatic discharge (ESD) is defined as the release of static electricity when two objects come into contact. While most ESD events are considered harmless, it can be an expensive problem in many industrial environments during production and storage. The damage from ESD to an LED may cause the product to demonstrate unusual characteristics such as:

- Increase in reverse leakage current lowered turn-on voltage
- Abnormal emissions from the LED at low current

The following recommendations are suggested to help minimize the potential for an ESD event.

One or more recommended work area suggestions:

- Ionizing fan setup
- ESD table/shelf mat made of conductive materials
- ESD safe storage containers

One or more personnel suggestion options:

- Antistatic wrist-strap
- Antistatic material shoes
- Antistatic clothes

Environmental controls:

- Humidity control (ESD gets worse in a dry environment)

Precaution for Use

b. EOS (Electrical Over Stress)

Electrical Over-Stress (EOS) is defined as damage that may occur when an electronic device is subjected to a current or voltage that is beyond the maximum specification limits of the device. The effects from an EOS event can be noticed through product performance like:

- Changes to the performance of the LED package
(If the damage is around the bond pad area and since the package is completely encapsulated the package may turn on but flicker show severe performance degradation.)
- Changes to the light output of the luminaire from component failure
- Components on the board not operating at determined drive power

Failure of performance from entire fixture due to changes in circuit voltage and current across total circuit causing trickle down failures. It is impossible to predict the failure mode of every LED exposed to electrical overstress as the failure modes have been investigated to vary, but there are some common signs that will indicate an EOS event has occurred:

- Anomalies noticed in the encapsulation and phosphor around the bond wires.
- This damage usually appears due to the thermal stress produced during the EOS event.

c. To help minimize the damage from an EOS event Seoul Semiconductor recommends utilizing:

- A surge protection circuit
- An appropriately rated over voltage protection device
- A current limiting device



Company Information

Published by

Seoul Semiconductor © 2013 All Rights Reserved.

Company Information

Seoul Semiconductor (www.SeoulSemicon.com) manufactures and packages a wide selection of light emitting diodes (LEDs) for the automotive, general illumination/lighting, Home appliance, signage and back lighting markets. The company is the world's fifth largest LED supplier, holding more than 10,000 patents globally, while offering a wide range of LED technology and production capacity in areas such as "nPola", "Acrich", the world's first commercially produced AC LED, and "Acrich MJT - Multi-Junction Technology" a proprietary family of high-voltage LEDs.

The company's broad product portfolio includes a wide array of package and device choices such as Acrich and Acirch2, high-brightness LEDs, mid-power LEDs, side-view LEDs, and through-hole type LEDs as well as custom modules, displays, and sensors.

Legal Disclaimer

Information in this document is provided in connection with Seoul Semiconductor products. With respect to any examples or hints given herein, any typical values stated herein and/or any information regarding the application of the device, Seoul Semiconductor hereby disclaims any and all warranties and liabilities of any kind, including without limitation, warranties of non-infringement of intellectual property rights of any third party. The appearance and specifications of the product can be changed to improve the quality and/or performance without notice.