

SPECIFICATION
MODEL : SPMWHT221MD5WAQ0S0

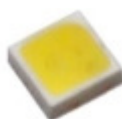

Approved rank :
V_F(A1, A2, A3, A4, A5)
CIE(Q1, Q2, Q3, Q4, Q5, Q6, Q7, Q8)
I_v(S1, S2, S3)

2323 WHITE LED Q0 RANK

CUSTOMER :	
CHECKED	APPROVED

SAMSUNG LED			
DRAWN	CHECKED		APPROVED
	SALES	QUALITY	

SAMSUNG LED CO., LTD.
314. MAETAN 3-DONG, YEONGTONG-GU,
SUWON-SI, GYEONGGI-DO, KOREA, 443-743

Contents

1.	Product Outline -----	3
2.	Absolute Maximum Rating -----	3
3.	Characteristics -----	3
4.	Chromaticity Diagram -----	4
5.	Typical Characteristic Graph -----	5
6.	Outline Drawing & Dimension -----	6
7.	Reliability Test Items & Conditions -----	7
8.	Solder Conditions -----	8
9.	Taping Dimension -----	9
10.	Label Structure -----	10
11.	Lot Number -----	10
12.	Reel Packing Structure -----	11
13.	Aluminum Packing Bag -----	12
14.	Precaution For Use -----	13
15.	Hazard Substance Analysis (SGS) -----	15
16.	Hazard Substance Analysis (SVHC) -----	22
17.	Revision History -----	30

1. Product Outline

1) Feature

- . Lead Frame Type LED Package (2.3 * 2.3 * t 0.7 mm)
- . Beam Angle ($\Delta\theta$: 120°)
- . GaN/Al₂O₃ Chip & Long Time Reliability

2) Applications

- . Indoor, Outdoor Display and etc.

2. Absolute Maximum Rating

Parameter	Symbol	Rating	Condition
Operating temperature range	T _{op}	-40 ~ +85°C	
Storage temperature range	T _{stg}	-40 ~ +100°C	
Junction Temperature	T _j	110°C	
Forward current	I _F	150 mA	
Peak Pulsed Forward Current	I _{FP}	300 mA	Duty 1/10 Pulse Width 10 ms
Reverse Voltage	V _R	0.7 ~ 1.2 V	I _R = 5 mA
Thermal resistance, Junction to Solder Point	R _{th, JS}	20°C/W	
Assembly Process Temp.		260°C, < 10 sec	
ESD		5 kV	HBM

3. Characteristics

Electrical / Optical Characteristics

(T_s : 25 °C)

Item	Symbol	Conditions	Rank	Min.	Typ.	Max.	Unit	
Forward Voltage (*)	V _F	I _F = 65 mA	WA	A1	2.8	-	2.9	V
				A2	2.9	-	3.0	
				A3	3.0	-	3.1	
				A4	3.1	-	3.2	
				A5	3.2	-	3.3	
Reverse Voltage	V _r	I _F = 5 mA	-	0.7	-	1.2	V	
Color Rendering	R _a	I _F = 65 mA	5	80	-	-	-	

Luminous Intensity / Luminous Flux

(T_s : 25 °C)

Symbol	Conditions	Model Name	Rank	Min.	Typ.	Max.	Unit	
I _v	I _F = 65 mA	SPMWHT221MD5WAQ0S0	S0	S1	6.87	-	7.88	cd
				S2	7.88	-	9.06	
				S3	9.06	-	10.42	
Φ _v	I _F = 65 mA	SPMWHT221MD5WAQ0S0	S0	S1	20.55	-	23.56	lm
				S2	23.56	-	27.09	
				S3	27.09	-	31.16	

* Luminous Flux (Φ_v) : Only reference data.

Electro-Optical Characteristics

If (mA)	Vf(V)	Power(W)	Flux(lm)	Lm/W
50	2.88	0.14	19.8	137
60	2.92	0.18	23.4	134
65 (Sorting Current)	2.94	0.19	25.2	132
70	2.96	0.21	27.0	130
80	3.00	0.24	30.4	127
90	3.04	0.27	33.8	124
100	3.08	0.31	37.1	121
150	3.25	0.49	52.6	108

※ Im values are representative references only.

Chromaticity Coordinate

(Ts : 25 °C)

Condition	Rank	x				y				
		I _F = 65 mA	Q0	Q1	0.3222	0.3290	0.3290	0.3215	0.3243	0.3300
Q2	0.3290			0.3366	0.3371	0.3290	0.3300	0.3369	0.3490	0.3417
Q3	0.3215			0.3290	0.3290	0.3206	0.3350	0.3417	0.3538	0.3461
Q4	0.3290			0.3371	0.3376	0.3290	0.3417	0.3490	0.3616	0.3538
Q5	0.3231			0.3290	0.3290	0.3222	0.3120	0.3180	0.3300	0.3243
Q6	0.3290			0.3361	0.3366	0.3290	0.3180	0.3245	0.3369	0.3300
Q7	0.3207			0.3290	0.3290	0.3196	0.3462	0.3538	0.3690	0.3602
Q8	0.3290			0.3376	0.3381	0.3290	0.3538	0.3616	0.3762	0.3690

- * Tolerance : V_F:±0.1 V, I_v:±5 %, x,y:±0.01, R_a :±3.0
- * Luminous Intensity measuring equipment : CAS140CT

4. Chromaticity Diagram

* CCT Range : 5665K±355K

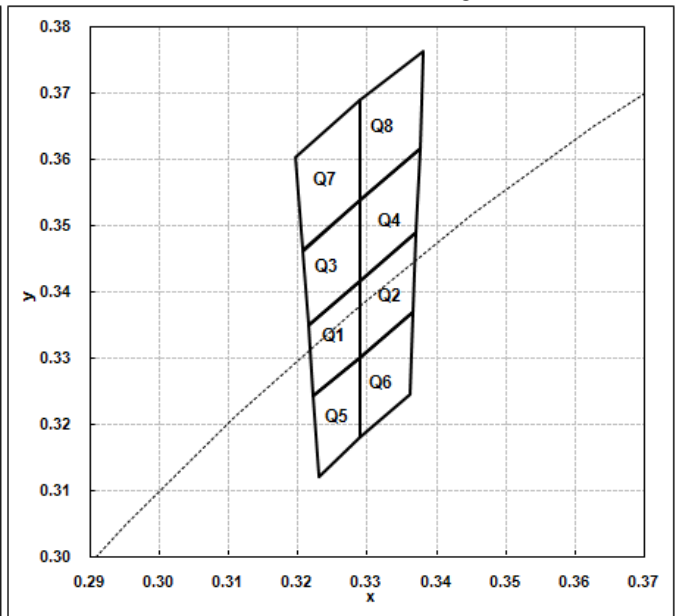
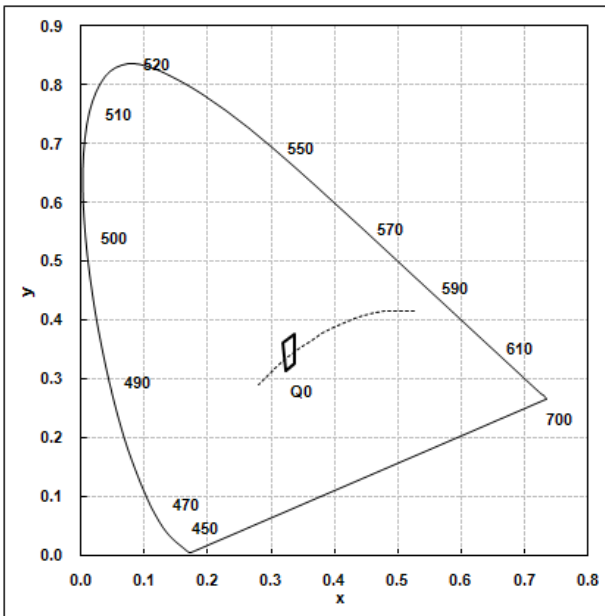

* Q0 = Q1+Q2+Q3+Q4+Q5+Q6+Q7+Q8

V _F	CIE	I _v
A1, A2, A3, A4, A5	Q1, Q2, Q3, Q4, Q5, Q6, Q7, Q8	S1, S2, S3

- * Each reel contains only one of the A1, A2, A3, A4 or A5 a segment (1/5) of the V_F rank.
- * Each Q1, Q2, Q3, Q4, Q5, Q6, Q7 or Q8 a segment (1/8) of the CIE rank.
- * Each reel contains only one of the S1, S2 or S3 a segment (1/3) of the I_v rank.

5. Typical Characteristics Graph

* These graphs show typical values.

($T_s : 25\text{ }^\circ\text{C}$)

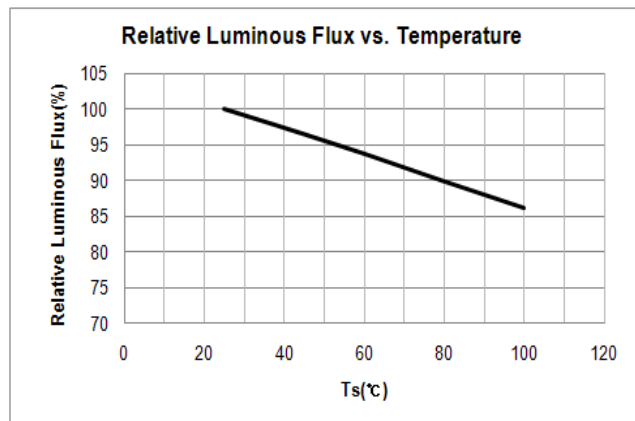
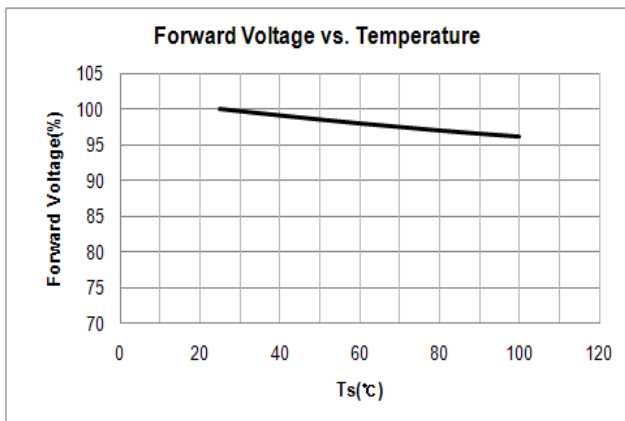
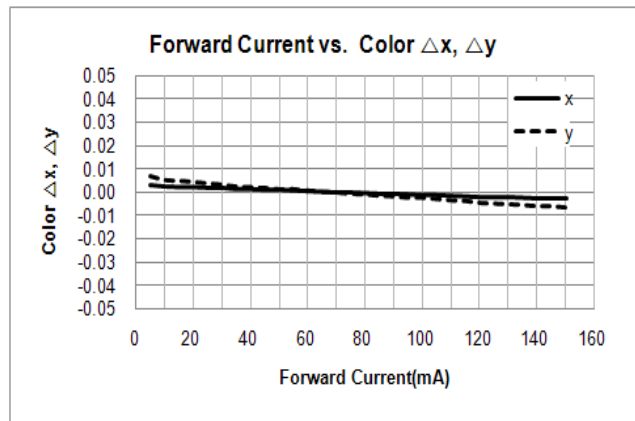
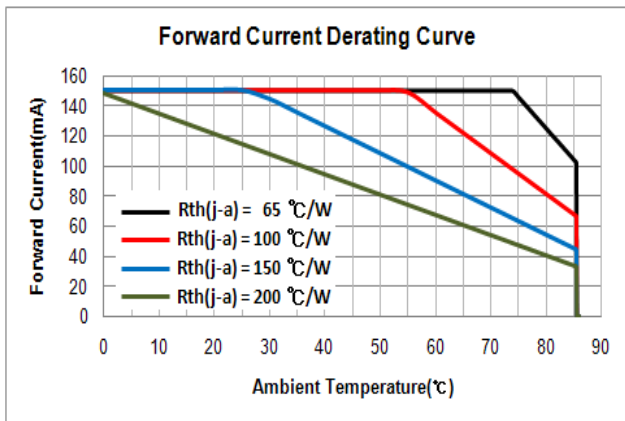
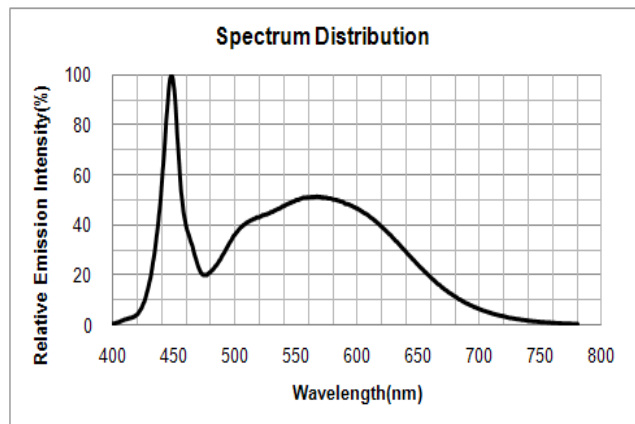
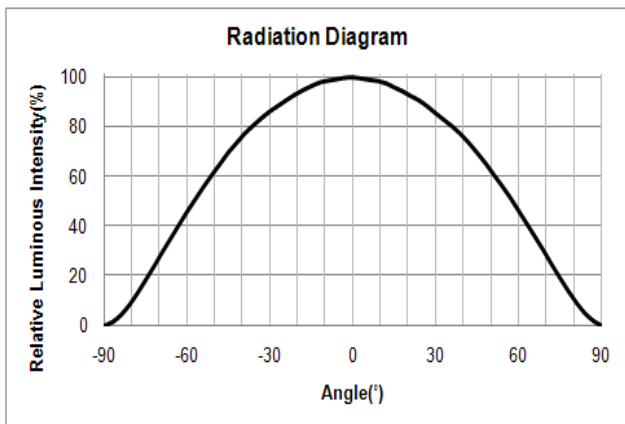
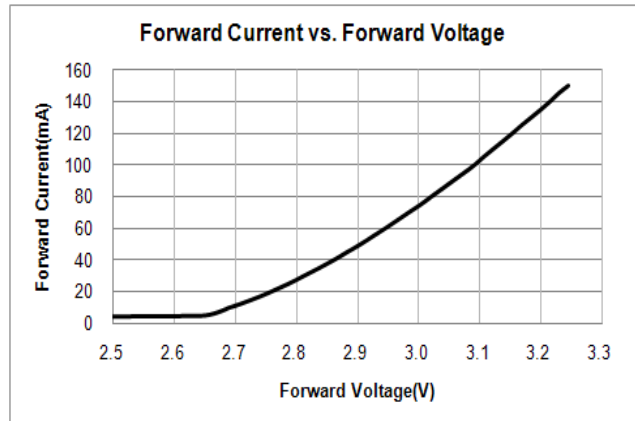
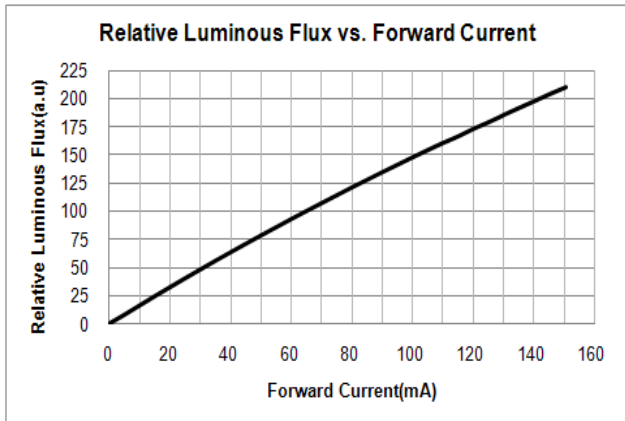

6. LED Package Outline Dimensions

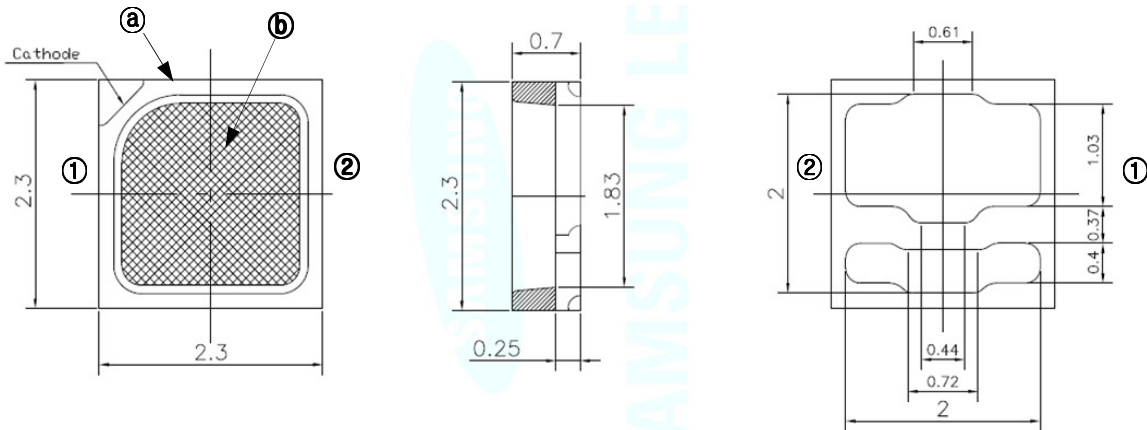

1. Tolerance is ± 0.1 mm
2. The maximum compressing force is 15N on the silicone (a)
3. Do not place pressure on the encapsulation resin (b)

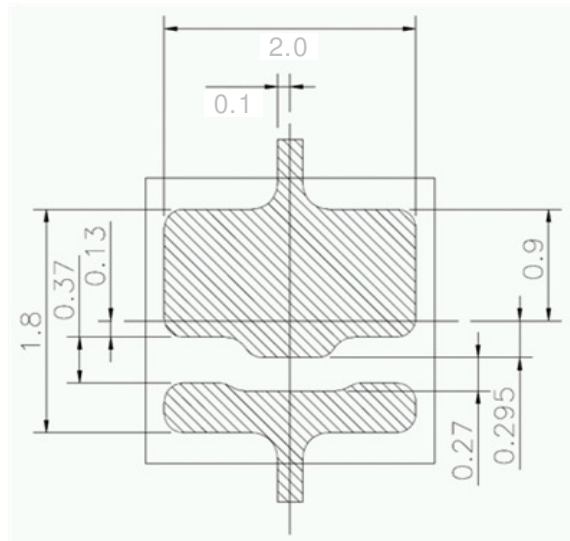

Recommend Land Pattern

* This LED has built-in ESD protection device(s) connected in parallel to LED chip(s).

Precautions

- ① The pressure on the LEDs will influence to the reliability of the LEDs. Precautions should be taken to avoid the strong pressure on the LEDs. Do not put stress on the LEDs during heating.
- ② Re-soldering should not be done after the LEDs have been soldered. If re-soldering is unavoidable, LED's characteristics should be carefully checked before and after such repair.
- ③ Do not stack assembled PCBs together. Since materials of LEDs is soft, abrasion between two PCB assembled with LED might cause catastrophic failure of the LEDs.

7. Reliability Test Items and Conditions

1) Test Items

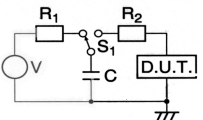
Test Item	Test Conditions	Test Hours/Cycles	Sample No	
MSL Test	125 °C 24hrs drying → 60 °C, 60 %RH 120hrs → 260 °C 10sec 3 cycles	1 cycle	50	
Room Temperature life test	25 °C±3 °C, DC150 mA	1,000 hrs	50	
High Temperature life test	85 °C±3 °C, DC110 mA	1,000 hrs	50	
High Temperature humidity life test	60 °C±3 °C, 95 %±2 %RH, DC150 mA	1,000 hrs	50	
High Temperature humidity On/Off test	85 °C±3 °C, 85 %±2 %RH, DC150 mA, On/2 sec, Off/5 sec	100,000 cycles	50	
Low Temperature life test	-40 °C±3 °C, DC100 mA	1,000 hrs	50	
Temperature humidity Cycle	-10 °C ~ 25 °C, 95 %RH ~ 65 °C, 95 %RH DC100 mA, 24 hrs/1 cycle	10 cycles	50	
Thermal Shock	-45 °C/15 min ↔ 125 °C/15 min, 150 Cycle => Reflow 260 °C → Hot plate 180 °C	1 cycle	100	
High Temperature Storage	Ta=100 °C±3 °C	1000 hrs	11	
Low Temperature Storage	Ta=-40 °C±3 °C	1000 hrs	11	
Temperature humidity Cycle	-10 °C ~ 25 °C, 95 %RH ~ 65 °C, 95 %RH 24 hrs/ 1 cycle	10 cycles	11	
ESD(HBM)		R1:10 MΩ, R2:1.5 kΩ, C:100 pF, V = ±5 kV	5 times	5
ESD(MM)		-R1:10 MΩ, R2:0, C:200 pF, V = ±0.2 kV	5 times	5
Vibration Test	100~2000~100 Hz, 200 m/s ² , Sweep 4 min, 48 min, X, Y, Z 3 direction, each 1 cycle	4 cycles	11	
Mechanical Shock Test	1500G, 0.5 ms, 3 shocks each X-Y-Z axis	5 cycles	11	

2) Criteria for Judging the Damage

Item	Symbol	Test Condition	Limit	
			Min	Max
Forward Voltage	V_F	$I_F = 65 \text{ mA}$	Init. Value*0.9	Init. Value*1.1
Luminous Intensity	I_V	$I_F = 65 \text{ mA}$	Init. Value*0.8	Init. Value*1.2

* USL : Upper Standard Level LSL : Lower Standard Level

8. Solder Conditions

1) Reflow Conditions (Pb Free)

Reflow Frequency : 2 times max.

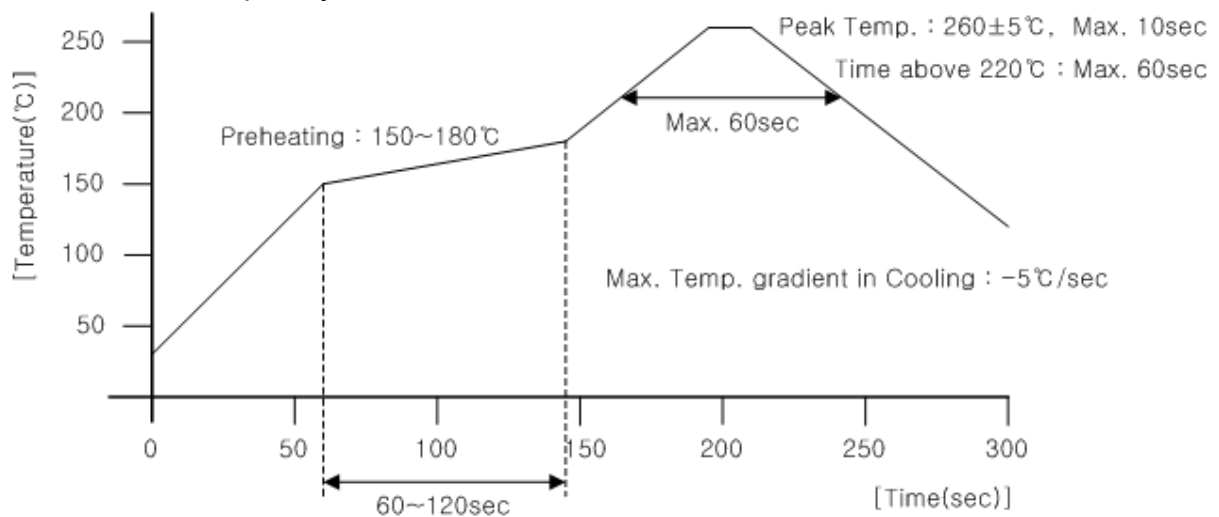

2) For Manual Soldering

Not more than 5 seconds @MAX300 °C, under soldering iron.

9. Taping Dimension

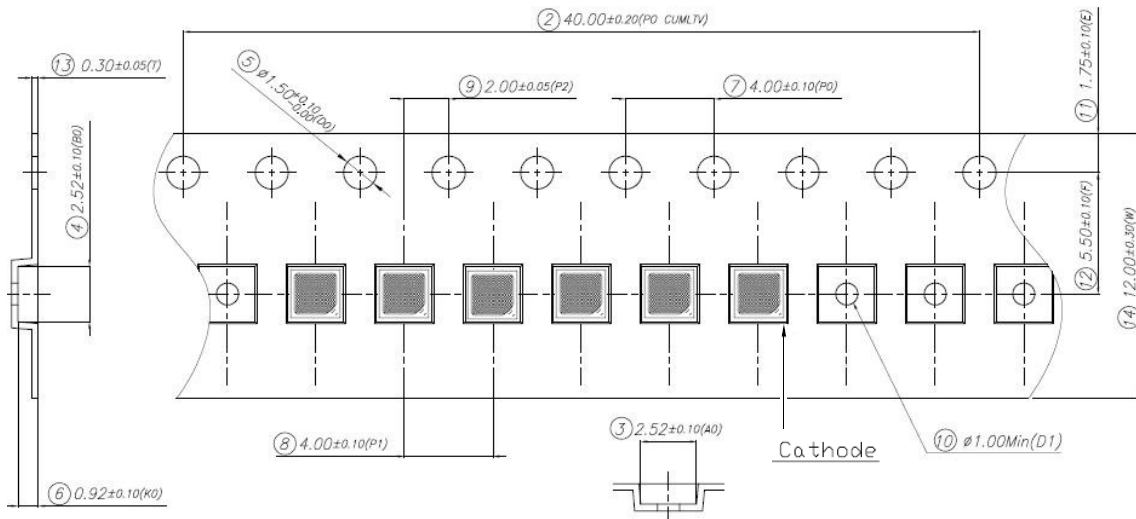

End

Start

More than 40 mm
Unloaded tape

Mounted with
Flash LED

More than (100~200)mm
Unloaded tape

Leading part more than
(200~400)mm

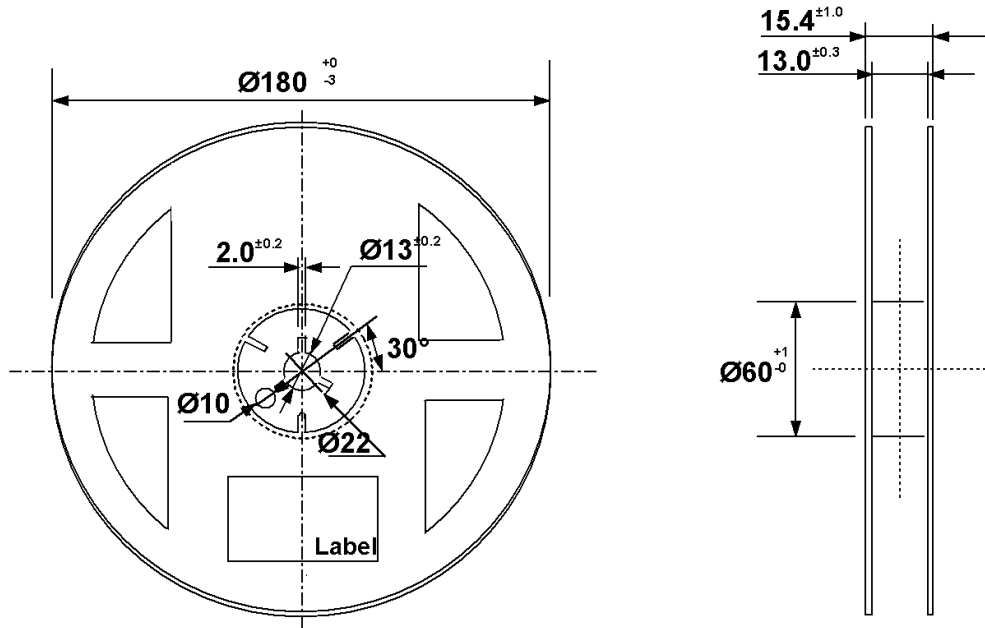

Tolerance ± 0.2 , Unit:mm

- (1) Quantity : The quantity/reel to be 4,000 pcs.
- (2) Cumulative Tolerance : Cumulative tolerance/10 pitches to be ± 0.2 mm
- (3) Adhesion Strength of Cover Tape : Adhesion strength to be 0.1-0.7 N when the cover tape is turned off from the carrier tape at 10 °C angle to be the carrier tape.
- (4) Packaging : P/N, Manufacturing data code no. and quantity to be indicated on a damp proof package.

10. Label Structure

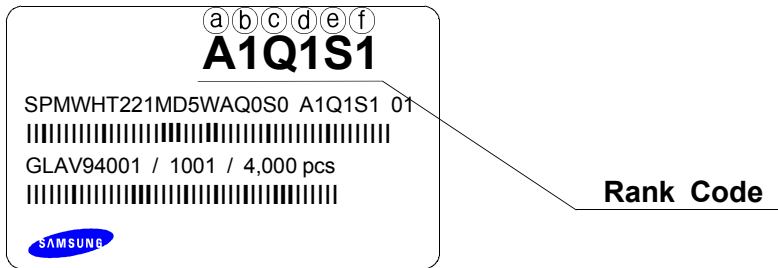

N.B) Denoted rank is the only example.

Rank Code

- ⒶⒷ : Forward Voltage(V_F) Rank (refer to page. 3)
- ⒸⒹ : Chromaticity Coordinate Rank (refer to page. 4)
- ⒺⒻ : Luminous Intensity(cd) Rank (refer to page. 3)

11. Lot Number

The Lot number is composed of the following characters

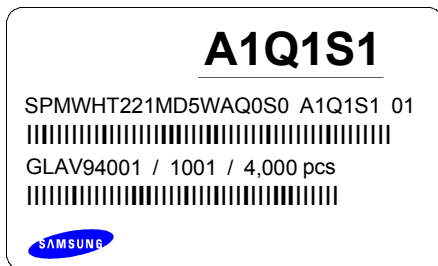

①②③④⑤⑥⑦⑧⑨ / 1ⒶⒷⒸ / 4,000 PCS

- ① : Production Site (S:SAMSUNG LED, G:GOSIN CHINA)
- ② : L (LED)
- ③ : Product State (A:Normality, B:Bulk, C:First Production, R:Reproduction, S:Sample)
- ④ : Year (V:2011, W:2012, X:2013...)
- ⑤ : Month (1 ~ 9, A, B)
- ⑥ : Day (1 ~ 9, A, B ~ V)
- ⑦⑧⑨ : SAMSUNG LED Product number (1 ~ 999)
- ⒶⒷⒸ : Reel Number (1 ~ 999)

12. Reel Packing Structure

Reel

A1Q1S1
 SPMWHT221MD5WAQ0S0 A1Q1S1 01
 GLAV94001 / 1001 / 4,000 pcs

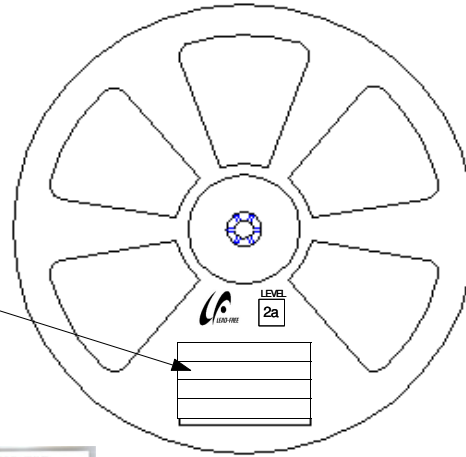
Aluminum Vinyl Bag

A1Q1S1
 SPMWHT221MD5WAQ0S0 A1Q1S1 01
 GLAV94001 / 1001 / 4,000 pcs



CAUTION LEVEL 2a
 MOISTURE SENSITIVE DEVICES
 This bag contains...

중요 사항
 이 알루미늄 비닐 봉지는 매우 습기 및 열에 민감한 제품을 보호하기 위해 제작되었습니다. 개봉 후에는 즉시 습기 저항을 잃기 쉬운 것을 경험할 수 있습니다. 습기 및 열에 민감한 제품을 보호하기 위해 이 제품을 개봉 후 사용 전에 항상 습기 저항 봉지를 닫아 주시기 바랍니다. 개봉 후 습기 저항 봉지에는 습기에 노출되는 흔적이 발견된 후에도 폐기되는 것을 방지하기 위해 습기 저항 봉지를 닫아 주시기 바랍니다. 습기 저항 봉지에는 습기에 노출되는 흔적이 발견된 후에도 폐기되는 것을 방지하기 위해 습기 저항 봉지를 닫아 주시기 바랍니다.

Important
 This Al Ripper bag is designed to protect the enclosed products from moisture and ESD. Once opened, the products should be handled only in the printed circuit board immediately. When not in use, please do not leave the products unprotected by the Al Ripper bag. To repair unused products, please ensure the zip-lock is completely sealed with the dry pack left inside.

Material : Paper(SW3B(B))

TYPE	SIZE(mm)		
	L	W	H
7inch	245	220	182

① SIDE

A1Q1S1
 SPMWHT221MD5WAQ0S0 A1Q1S1 01
 GLAV94001 / 1001 / 40,000 pcs



[Box Label]

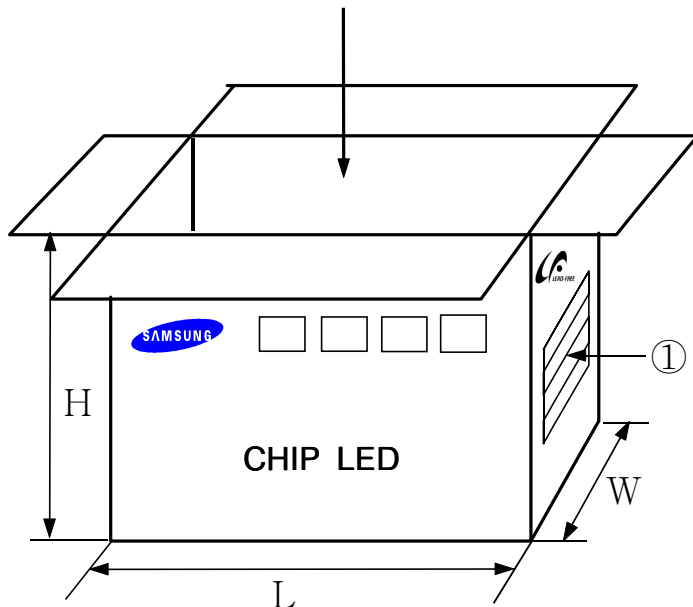

13. Aluminum Vinyl Bag



CAUTION

This bag contains
MOISTURE SENSITIVE DEVICES

LEVEL
2a

1. Shelf life in sealed bag: 12 months at <40°C and <90% relative humidity (RH)
2. Peak package body temperature: 240 °C
3. After this bag is opened, devices that will be subjected to reflow solder or other high temperature processes must be:
 - a. Mounted within 672 hours at factory conditions of equal to or less than 30°C / 60% RH, or
 - b. Stored at <10% RH
4. Devices require bake, before mounting, if:
 - a. Humidity Indicator Card is >65% when read at 23±5°C, or
 - b. 2a is not met.
5. If baking is required, devices must be baked for 1 hours at 60±5°C

Note: if device containers cannot be subjected to high temperature or shorter bake times are desired, reference IPC/JEDEC J-STD-033 for bake procedure,

Bag seal due date: _____
(if blank, see code label)

Note: Level and body temperature by IPC/JEDEC J-STD-020

A1Q1S1

SPMWHT221MD5WAQ0S0 A1Q1S1 01

GLAV94001 / 1001 / 4,000 pcs

SAMSUNG



주의 사항
이 알루미늄 지퍼 백은 습기 및 정전기로부터 제품을 보호하기 위하여 제작되었습니다. 개봉 후에는 즉시 솔더 작업을 실시하는 것을 권장합니다.
습기 및 정전기로부터 제품을 보호 하기 위해서 개봉 후 사용하지 않는 자재는 본 팩에 넣어 보관 하시기 바랍니다. 사용하지 않는 자재를 본 팩에 넣을 때는 반드시 동봉된 드라이 팩과 함께 넣고 지퍼부분을 완전하게 밀봉하여 주시기 바랍니다.

Important
This Al Zipper bag is designed to protect the enclosed products from moisture and ESD. Once opened, the products should be soldered onto the printed circuit board immediately. When not in use, please do not leave the products unprotected by the Al Zipper Bag. To repack unused products., please ensure the zip-lock is completely sealed with the dry pack left inside.

Silica gel & Humidity Indicator Card in Aluminum Vinyl Bag

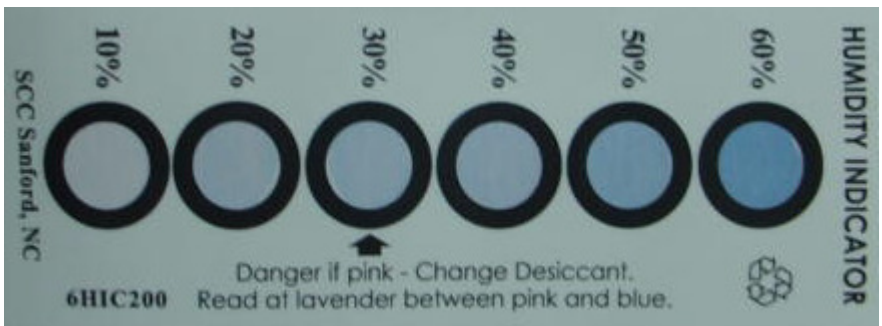

14. Precaution for Use (취급상 주의사항)

- 1) For over-current-proof function, customers are recommended to apply resistors to prevent sudden change of the current caused by slight shift of the voltage.

과전류 방지를 위해 전압의 미세한 이동에 의해 야기되는 전류의 순간 변화를 방지하기 위해 저항 등의 설치를 권장함.

- 2) This device should not be used in any type of fluid such as water, oil, organic solvent, etc. When washing is required, IPA is recommended to use.

제품은 물, 오일, 유기물과 같은 액체 타입에서의 사용은 제한되며, 세정이 필요할 시에는 IPA 사용을 권장함.

- 3) When the LEDs illuminate, operating current should be decided after considering the ambient maximum temperature.

LED의 발광 시, 동작 전류는 주변 최고온도를 고려하여 결정되어야 함.

- 4) LEDs must be stored in a clean environment.

If the LEDs are to be stored for 3 months or more after being shipped from SLED, they should be packed by a sealed container with nitrogen gas injected.

(Shelf life of sealed bags: 12 months, temp. ~40 °C, ~90 %RH)

LED의 보관은 청정한 환경에서 보존되어야 하며, 만약 삼성LED로부터 공급받는 후 3개월 또는 그 이상 보관이 필요하다면 질소 가스를 동봉한 보존용기에 보관되어야 함.

(보존 bag의 수명 : 12 개월, 보존 온도 ~40 °C, 습도 ~90 %RH)

- 5) After storage bag is open, device subjected to soldering, solder reflow, or other high temperature processes must be:

보존 Bag이 개봉된 후에, 납땀이나 reflow 등의 높은 온도에 노출되는 제품은 다음의 사항에 부합되어야 함.

- a. Mounted within 672 hours (28 days) at an assembly line with a condition of no more than 30 °C/60 %RH,

a. 제품은 30 °C/60 %RH보다 같거나 낮은 조립조건에서 672시간 (28일) 이내에 조립해야 함.

- b. Stored at <10 %RH.

b. 10 % 이하의 상대습도에서 보관되어야 함.

- 6) Repack unused Products with anti-moisture packing, fold to close any opening and then store in a dry place.

사용하지 않은 제품은 방습팩에 넣어 개봉 부위를 닫아서 다시 포장한 후, 건조한 장소에서 보관할 것을 권장함.

7) Devices require baking before mounting, if humidity card reading is $>65\%$ at $23\pm 5\text{ }^{\circ}\text{C}$.

만약 습도표시카드의 수치가 $23\pm 5\text{ }^{\circ}\text{C}$ 에서 65% 이상이라면, 제품 실장 전에 baking하여야 함.

8) Devices must be baked for 1 hour at $65\pm 5\text{ }^{\circ}\text{C}$, if baking is required.

만약 baking이 필요하다면, 제품은 $65\pm 5\text{ }^{\circ}\text{C}$ 에서 1시간 정도 baking 되어야 함.

9) The LEDs are sensitive to the static electricity and surge. It is recommended to use a wrist band or anti-electrostatic glove when handling the LEDs.

LED는 정전기 및 서지에 민감한 제품이므로, LED 제품을 다룰 시에는 정전기 방지장갑이나 손목밴드를 사용하기를 권장함.

If voltage exceeding the absolute maximum rating is applied to LEDs, it may cause damage or even destruction to LED devices.

만약 절대 허용치를 초과하는 전압이 LED에 가해지면, LED 소자는 파괴되거나 손상될 수 있음.

Damaged LEDs may show some unusual characteristics such as increase in leak current, lowered turn-on voltage, or abnormal lighting of LEDs at low current.

손상된 제품은 누설전류의 증가, Turn on 전압의 저하, 저 전류에서의 점등불량 등의 이상 거동을 보일 수 있음.

15. Hazard Substance Analysis - SGS



Test Report No. F690501/LF-CTSAYAA11-16101

Issued Date: 2011. 05. 24 Page 1 of 7

To: **SAMSUNG LED**
 #314, Maetan-Dong
 Youngtong-Gu
 Suwon-si
 Gyeonggi-do
 Korea

The following merchandise was submitted and identified by the client as :

SGS File No. : AYAA11-16101
 Product Name : 2323
 Item No./Part No. : N/A
 Received Date : 2011. 05. 17
 Test Period : 2011. 05. 18 to 2011. 05. 24
 Test Results : For further details, please refer to following page(s)
 Test Performed : SGS Korea tested the sample(s) selected by applicant with following results.

Timothy Jeon
 Jinhee Kim
 Cindy Park
 Jerry Jung/ Testing Person

SGS Korea Co. Ltd.

Jeff Jang / Chemical Lab Mgr

This document is issued by the Company subject to its General Conditions of Service printed hereon, available on request or accessible at www.sgs.com/sgs/sgskorea/sgs and, for electronic format documents, subject to Terms and Conditions for Electronic Documents at www.sgs.com/sgs/sgskorea/sgs. Member is aware of the limitation of liability, indemnification and jurisdiction issues defined therein. Any holder of this document is advised that information contained herein reflects the Company's findings at the time of its completion only and under the terms of Client's instructions, if any. The Company's sole responsibility is to its Client and this document does not constitute parties to a transaction from waiving of their rights and obligations under the transaction documents. This document cannot be reproduced except in full, without prior written approval of the Company. Unless otherwise stated the results shown in this report refer only to the sample(s) tested and such sample(s) are retained for 180 days only.



Test Report No. F690501/LF-CTSAYAA11-16101

Issued Date: 2011. 05. 24 Page 2 of 7

Sample No. : AYAA11-16101.001
 Sample Description : 2323
 Item No./Part No. : N/A

Heavy Metals

Test Items	Unit	Test Method	MDL	Results
Cadmium (Cd)	mg/kg	With reference to IEC 62321:2008, ICP	0.5	N.D.
Lead (Pb)	mg/kg	With reference to IEC 62321:2008, ICP	5	N.D.
Mercury (Hg)	mg/kg	With reference to IEC 62321:2008, ICP	2	N.D.
Hexavalent Chromium (Cr VI)	mg/kg	With reference to IEC 62321:2008, UV-VIS	1	N.D.
Arsenic (As)	mg/kg	With reference to EPA 3052(1996), US EPA 6010B(1996), ICP	10	N.D.
Sb (Sb2O3)	mg/kg	With reference to EPA 3052(1996), US EPA 6010B(1996), ICP	10	N.D.
Beryllium (Be)	mg/kg	With reference to EPA 3050B(1996), US EPA 6010B(1996), ICP	0.5	N.D.

Flame Retardants-PBBs/PBDEs

Test Items	Unit	Test Method	MDL	Results
Monobromobiphenyl	mg/kg	With reference to IEC 62321:2008, GC-MS	5	N.D.
Dibromobiphenyl	mg/kg	With reference to IEC 62321:2008, GC-MS	5	N.D.
Tribromobiphenyl	mg/kg	With reference to IEC 62321:2008, GC-MS	5	N.D.
Tetrabromobiphenyl	mg/kg	With reference to IEC 62321:2008, GC-MS	5	N.D.
Pentabromobiphenyl	mg/kg	With reference to IEC 62321:2008, GC-MS	5	N.D.
Hexabromobiphenyl	mg/kg	With reference to IEC 62321:2008, GC-MS	5	N.D.
Heptabromobiphenyl	mg/kg	With reference to IEC 62321:2008, GC-MS	5	N.D.
Octabromobiphenyl	mg/kg	With reference to IEC 62321:2008, GC-MS	5	N.D.
Nonabromobiphenyl	mg/kg	With reference to IEC 62321:2008, GC-MS	5	N.D.
Decabromobiphenyl	mg/kg	With reference to IEC 62321:2008, GC-MS	5	N.D.
Monobromodiphenyl ether	mg/kg	With reference to IEC 62321:2008, GC-MS	5	N.D.
Dibromodiphenyl ether	mg/kg	With reference to IEC 62321:2008, GC-MS	5	N.D.
Tribromodiphenyl ether	mg/kg	With reference to IEC 62321:2008, GC-MS	5	N.D.
Tetrabromodiphenyl ether	mg/kg	With reference to IEC 62321:2008, GC-MS	5	N.D.
Pentabromodiphenyl ether	mg/kg	With reference to IEC 62321:2008, GC-MS	5	N.D.

NOTE: (1) N.D. = Not detected.(<MDL)
 (2) mg/kg = ppm
 (3) MDL = Method Detection Limit
 (4) - = No regulation
 (5) ** = Qualitative analysis (No Unit)
 (6) * = Boiling-water-extraction:
 Negative = Absence of CrVI coating
 Positive = Presence of CrVI coating; the detected concentration in boiling-water-extraction solution is equal or greater than 0.02 mg/kg with 50 cm2 sample surface area.

This document is issued by the Company subject to its General Conditions of Service printed hereon, available on request at www.sgs.com and, for electronic format documents, subject to Terms and Conditions for Electronic Documents at www.sgs.com. Member is aware of the limitation of liability, indemnification and jurisdiction issues defined therein. Any holder of this document is advised that information contained herein reflects the Company's findings at the time of its issuance only and within the limits of Client's instructions, if any. The Company's sole responsibility is to its Client and this document does not constitute parties to a transaction from exercising all their rights and obligations under the transaction documents. This document cannot be reproduced except in full, without prior written approval of the Company. Unless otherwise stated the results shown in this report refer only to the sample(s) tested and such sample(s) are retained for 180 days only.

P052 Version4

SGS Korea Co.,Ltd.

322, The O valley, 556-0, Hogeje-dong, Dongan-gu, Anyang-si, Gyeonggi-do, Korea 431-000
 t +82 (0)31 4600 000 f +82 (0)31 4600 050 <http://www.sgs.com> www.kr.sgs.com www.kr.sgs.com/greentab

Member of the SGS Group (Société Générale de Surveillance)



Test Report No. F690501/LF-CTSAYAA11-16101

Issued Date: 2011. 05. 24 Page 3 of 7

Sample No. : AYAA11-16101.001
 Sample Description : 2323
 Item No./Part No. : N/A

Flame Retardants-PBBs/PBDEs

Test Items	Unit	Test Method	MDL	Results
Hexabromodiphenyl ether	mg/kg	With reference to IEC 62321:2008, GC-MS	5	N.D.
Heptabromodiphenyl ether	mg/kg	With reference to IEC 62321:2008, GC-MS	5	N.D.
Octabromodiphenyl ether	mg/kg	With reference to IEC 62321:2008, GC-MS	5	N.D.
Nonabromodiphenyl ether	mg/kg	With reference to IEC 62321:2008, GC-MS	5	N.D.
Decabromodiphenyl ether	mg/kg	With reference to IEC 62321:2008, GC-MS	5	N.D.

Phthalates

Test Items	Unit	Test Method	MDL	Results
Di-isodecyl phthalate (DIDP)	mg/kg	US EPA 8061A, GC/MS	50	N.D.
Di-isononyl phthalate (DINP)	mg/kg	US EPA 8061A, GC/MS	50	N.D.
Di-n-octyl phthalate (DNOP)	mg/kg	US EPA 8061A, GC/MS	50	N.D.
Di-ethyl phthalate(DEP)	mg/kg	US EPA 8061A, GC/MS	50	N.D.
Di-methyl phthalate (DMP)	mg/kg	US EPA 8061A, GC/MS	50	N.D.

Halogen Contents

Test Items	Unit	Test Method	MDL	Results
Bromine(Br)	mg/kg	BS EN 14582:2007, IC	30	N.D.
Chlorine(Cl)	mg/kg	BS EN 14582:2007, IC	30	N.D.
Fluorine(F)	mg/kg	BS EN 14582:2007, IC	30	N.D.
Iodine(I)	mg/kg	BS EN 14582:2007, IC	50	N.D.

Organotin Compounds

Test Items	Unit	Test Method	MDL	Results
Tributyltin (TBT)	mg/kg	DIN 38407-13, GC/MS	0.1	N.D.

NOTE: (1) N.D. = Not detected.(<MDL)
 (2) mg/kg = ppm
 (3) MDL = Method Detection Limit
 (4) - = No regulation
 (5) ** = Qualitative analysis (No Unit)
 (6) * = Boiling-water-extraction:
 Negative = Absence of CrVI coating
 Positive = Presence of CrVI coating; the detected concentration in boiling-water-extraction solution is equal or greater than 0.02 mg/kg with 50 cm2 sample surface area.

This document is issued by the Company subject to its General Conditions of Service printed on back, available on request or downloadable at www.sgs.com and, for electronic format documents, subject to Terms and Conditions for Electronic Documents at www.sgs.com. Member is aware of the limitation of liability, indemnification and jurisdiction issues defined therein. Any holder of this document is advised that information contained herein reflects the Company's findings at the time of its issuance only and within the limits of Client's instructions, if any. The Company's sole responsibility is to its Client and this document does not constitute parties to a transaction from acceptance of their rights and obligations under the transaction documents. This document cannot be reproduced except in full, without prior written approval of the Company. Unless otherwise stated the results shown in this report refer only to the sample(s) tested and each sample(s) are retained for 180 days only.

P052 Version4

SGS Korea Co., Ltd.

322, The O valley, 555-0, Hogeje-dong, Dongan-gu, Anyang-si, Gyeonggi-do, Korea 431-000
 t +82 (0)31 4508 000 f +82 (0)31 4508 050 <http://www.sgsled.co.kr> www.kr.sgs.com sgs@sgs.com

Member of the SGS Group (Société Générale de Surveillance)



Test Report No. F690501/LF-CTSAYAA11-16101

Issued Date: 2011. 05. 24 Page 4 of 7

Sample No. : AYAA11-16101.001
 Sample Description : 2323
 Item No./Part No. : N/A

Organotin Compounds

Test Items	Unit	Test Method	MDL	Results
Triphenyltin (TPhT)	mg/kg	DIN 38407-13 , GC/MS	0.1	N.D.
Dibutyltin (DBT)	mg/kg	DIN 38407-13 , GC/MS	0.1	N.D.
Diocetyl(DOT)	mg/kg	DIN 38407-13 , GC/MS	0.1	N.D.
Monobutyltin (MBT)	mg/kg	DIN 38407-13 , GC/MS	0.1	N.D.
Bis (tributyltin)oxide (TBTO)	mg/kg	DIN 38407-13 , GC/MS	0.1	N.D.

Other(s)

Test Items	Unit	Test Method	MDL	Results
PFOS(Perfluorooctane Sulfonates-Acid/Metal Salt/Amide)	mg/kg	US EPA 3540C/3550C, LC/MS	1	N.D.

- NOTE:
- (1) N.D. = Not detected.(<MDL)
 - (2) mg/kg = ppm
 - (3) MDL = Method Detection Limit
 - (4) - = No regulation
 - (5) ** = Qualitative analysis (No Unit)
 - (6) * = Boiling-water-extraction:
 Negative = Absence of CrVI coating
 Positive = Presence of CrVI coating; the detected concentration in boiling-water-extraction solution is equal or greater than 0.02 mg/kg with 50 cm2 sample surface area.

This document is issued by the Company subject to its General Conditions of Service printed hereon, available on request or available at www.sgs.com and www.kor.sgs.com and, for electronic format documents, subject to Terms and Conditions for Electronic Documents at www.sgs.com. Attention is drawn to the limitation of liability, indemnification and jurisdiction issues defined therein. Any holder of this document is advised that information contained herein reflects the Company's findings at the time of its completion only and under the terms of Client's specifications, if any. The Company's sole responsibility is to its Client and this document does not constitute advice or a transaction from marketing all their rights and obligations under the contract documents. This document cannot be reproduced except in full, without prior written approval of the Company. Any unauthorised alteration, forgery or falsification of the content or appearance of this document is unlawful and constitutes a criminal offence under the applicable criminal law. Unless otherwise stated the results shown in this document apply only to the sample(s) tested and such sample(s) are retained for 180 days only.

F052 Version4

SGS Korea Co., Ltd.

322, The O valley, 555-8, Hoggae-dong, Dongan-gu, Anyang-si, Gyeonggi-do, Korea 431-000
 t +82 (0)31 4508 000 f +82 (0)31 4506 050 <http://www.sgs.com> www.kr.sgs.com pr@sgs.com

Member of the SGS Group (Société Générale de Surveillance)



Test Report No. F690501/LF-CTSAYAA11-16101

Issued Date: 2011. 05. 24 Page 5 of 7

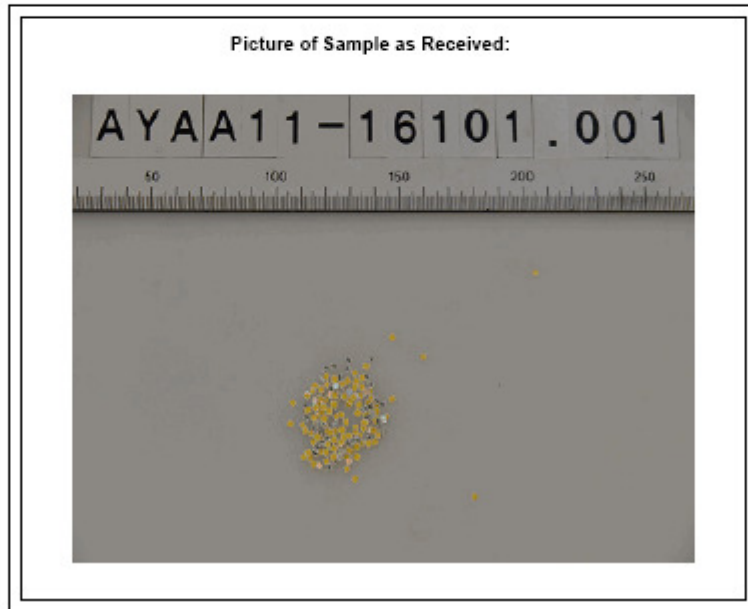

NOTE:

- (1) N.D. = Not detected.(<MDL)
- (2) mg/kg = ppm
- (3) MDL = Method Detection Limit
- (4) - = No regulation
- (5) ** = Qualitative analysis (No Unit)
- (6) * = Boiling-water-extraction:
 Negative = Absence of CrVI coating
 Positive = Presence of CrVI coating; the detected concentration in boiling-water-extraction solution is equal or greater than 0.02 mg/kg with 50 cm2 sample surface area.

This document is issued by the Company subject to its General Conditions of Service printed hereafter, available on request or accessible at www.sgs.com and, for electronic format documents, subject to Terms and Conditions for Electronic Documents at www.sgs.com/sgsportal. Attention is drawn to the limitation of liability, indemnification and jurisdiction issues defined therein. Any holder of this document is advised that information contained therein reflects the Company's findings at the time of its completion only and under the terms of Client's specifications, if any. The Company's sole responsibility is to its Client and this document does not constitute advice or a guarantee from matching all their rights and obligations under the contract documents. This document cannot be reproduced except in full, without prior written approval of the Company. Any unauthorised alteration, forgery or falsification of the content or appearance of this document is unlawful and offences may be prosecuted to the full extent of the law. Unless otherwise stated the results shown in this document apply only to the sample(s) tested and such sample(s) are retained for 180 days only.

F052 Version4

SGS Korea Co., Ltd.

322, The O valley, 555-0, Hoggae-dong, Dongan-gu, Anyang-si, Gyeonggi-do, Korea 431-000
 t +82 (0)31 4508 000 f +82 (0)31 4506 050 <http://www.sgs.com> www.kr.sgs.com sgs@sgs.com

Member of the SGS Group (Société Générale de Surveillance)



Test Report No. F690501/LF-CTSAYAA11-16101

Issued Date: 2011. 05. 24 Page 6 of 7

Flow Chart for RoHS:Cd/Pb/Hg/Cr⁶⁺/PBBs&PBDEs Testing

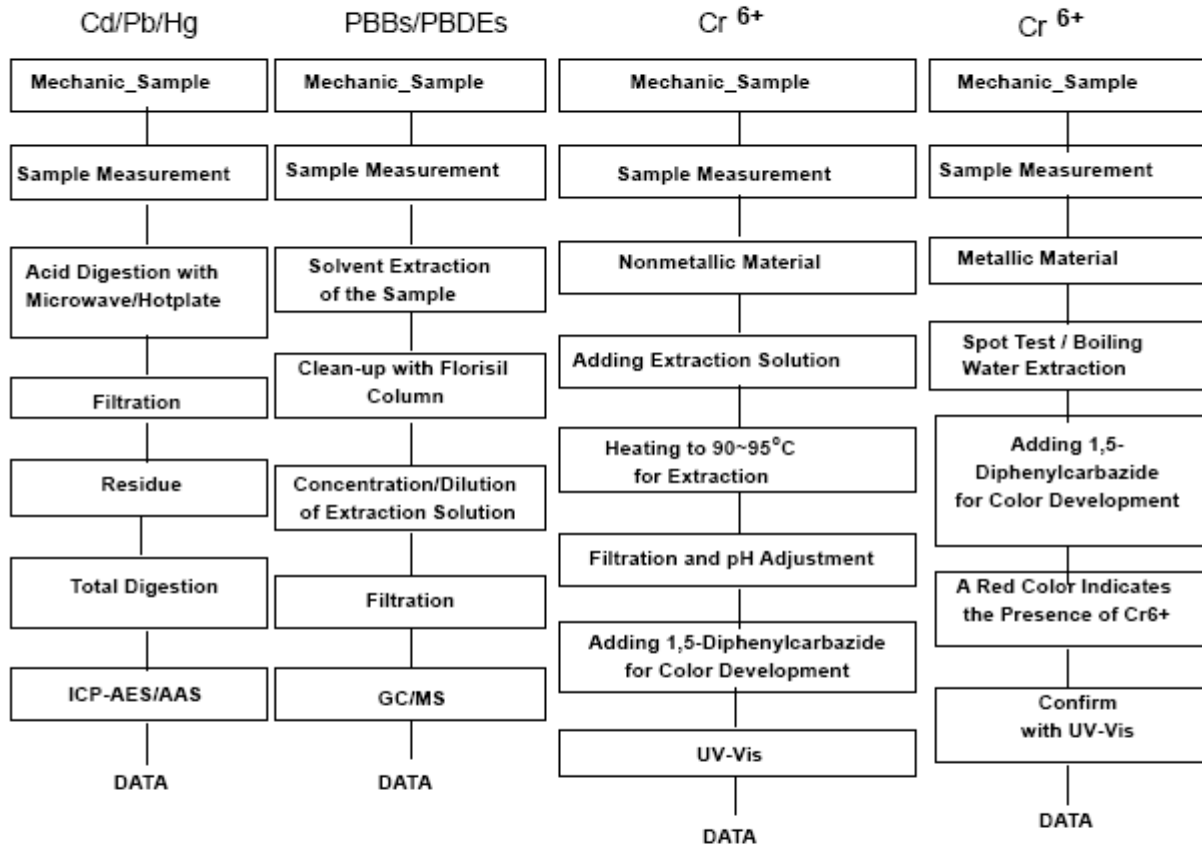

The samples were dissolved totally by pre-conditioning method according to above flow chart for Cd,Pb,Hg.

Section Chief : Gilsae Yi

NOTE:

- (1) N.D. = Not detected.(<MDL)
- (2) mg/kg = ppm
- (3) MDL = Method Detection Limit
- (4) - = No regulation
- (5) ** = Qualitative analysis (No Unit)
- (6) * = Boiling-water-extraction:
 Negative = Absence of CrVI coating
 Positive = Presence of CrVI coating; the detected concentration in boiling-water-extraction solution is equal or greater than 0.02 mg/kg with 50 cm² sample surface area.

This document is issued by the Company subject to its General Conditions of Service printed hereon, available on request or downloadable at www.sgs.com and, for electronic format documents, subject to Terms and Conditions for Electronic Documents at www.sgs.com. Member is aware of the limitation of liability, indemnification and jurisdiction issues defined therein. Any holder of this document is advised that information contained herein reflects the Company's findings at the time of its issuance only and within the limits of Client's instructions, if any. The Company's sole responsibility is to its Client and this document does not constitute parties to a transaction from accepting of their rights and obligations under the transaction documents. This document cannot be reproduced except in full, without prior written approval of the Company. Any unauthorised alteration, copying or distribution of the content or appearance of this document is prohibited and will be prosecuted to the fullest extent of the law. Unless otherwise stated the results shown in this report apply only to the sample(s) tested and such sample(s) are retained for 180 days only.

F052 Version4

SGS Korea Co.,Ltd.

322, The O valley, 555-0, Hogeje-dong, Dongan-gu, Anyang-si, Gyeonggi-do, Korea 431-000
 t +82 (0)31 4500 000 f +82 (0)31 4500 050 <http://korea.sgs.com> www.kr.sgs.com kr@sgs.com

Member of the SGS Group (Société Générale de Surveillance)



Test Report No. F690501/LF-CTSAYAA11-16101

Issued Date: 2011. 05. 24 Page 7 of 7

Flow Chart for Halogen Test

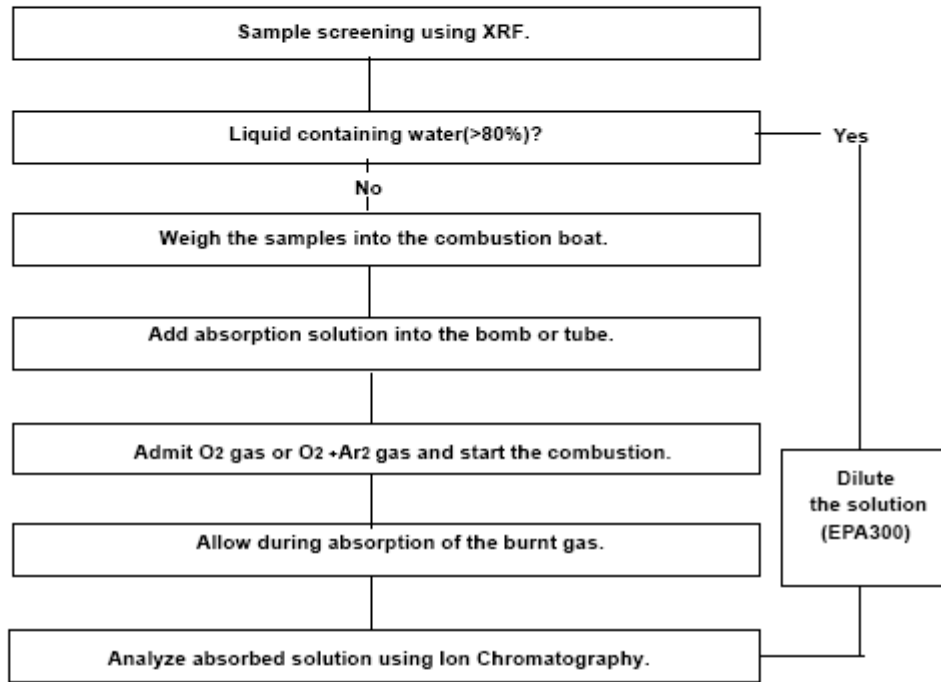

*** End ***

NOTE:

- (1) N.D. = Not detected.(<MDL)
- (2) mg/kg = ppm
- (3) MDL = Method Detection Limit
- (4) - = No regulation
- (5) ** = Qualitative analysis (No Unit)
- (6) * = Boiling-water-extraction:
 Negative = Absence of CrVI coating
 Positive = Presence of CrVI coating; the detected concentration in boiling-water-extraction solution is equal or greater than 0.02 mg/kg with 50 cm2 sample surface area.

This document is issued by the Company subject to its General Conditions of Service printed herewith, available on request or available at www.sgs.com and, for electronic format documents, subject to Terms and Conditions for Electronic Documents at www.sgs.com. Attention is drawn to the limitation of liability, indemnification and jurisdiction issues defined therein. Any holder of this document is advised that information contained therein reflects the Company's findings at the time of its completion only and under the terms of Client's regulations, if any. The Company's sole responsibility is to its Client and this document does not constitute advice or a transition from checking all their rights and obligations under the contract documents. This document cannot be reproduced except in full, without prior written approval of the Company. Any unauthorised alteration, copying or distribution of this document is prohibited and will be prosecuted to the full extent of the law. Unless otherwise stated the results shown in this report apply only to the sample(s) tested and such sample(s) are retained for 180 days only.

F052 Version4

SGS Korea Co., Ltd.

322, The O valley, 555-0, Hoggae-dong, Dongan-gu, Anyang-si, Gyeonggi-do, Korea 431-000
 t +82 (0)31 4508 000 f +82 (0)31 4506 050 <http://www.sgsled.co.kr> www.kr.sgs.com www.kr.sgs.com/pressrel

Member of the SGS Group (Société Générale de Surveillance)

16. Hazard Substance Analysis - SVHC(REACH)



Test Report No. F690501/LF-CTSAYAA11-16098 Issued Date: May 24, 2011 Page 1 of 8

To: **SAMSUNG LED**
 #314, Maetan3-Dong
 Yeongtong-gu
 Suwon-city
 Gyeonggi-do
 Korea

The following sample(s) was/were submitted and identified by/on behalf of the client as:-

Product Name : 2323 White
Item/Part Name : N/A
SGS File No. : AYAA11-16098
Received Date : May 17, 2011
Test Period : May 18, 2011 ~ May 24, 2011
Test Performed : SGS Korea tested the sample(s) selected by applicant with following results
Test Requested : Forty-six (46) substances in the Candidate List of Substances of Very High Concern (SVHC) for authorization published by European Chemicals Agency (ECHA) on and before December 15, 2010 regarding Regulation (EC) No 1907/2006 concerning the REACH.
Test Method : Please refer to next page(s).
Test Result(s) : Please refer to next page(s).
Summary : According to the specified scope and analytical technique, concentrations of all SVHC are <0.1% in the submitted sample(s).

Timothy Jeon
 Cindy park
 Jinhee Kim
 Sophia Kim
 /Testing Person

SGS Korea Co., Ltd

Jeff Jang / Technical Mgr

This document is issued by the Company subject to its General Conditions of Service printed overleaf, available on request or accessible at www.sgs.com and conditions, and, for electronic format documents, subject to Terms and Conditions for Electronic Documents at www.sgs.com and www.sgs.com. All rights are reserved to the Company. All information is given to the best of our knowledge, skill and judgment. Any holder of this document is notified that the information contained herein reflects the Company's findings at the time of its issuance only and within the limits of Client's instructions, if any. The Company's sole responsibility is to its Client and this document does not constitute advice or a transaction. Any alteration, copy or reproduction of the content or appearance of this document is prohibited and offenders may be prosecuted to the fullest extent of the law. Unless otherwise stated the results shown in this report refer only to the sample(s) tested and such sample(s) are retained for 90 days only.

F052 Version4

SGS Korea Co., Ltd.

322, The O valley, 555-0, Hoggia-dong, Dongan-gu, Anyang-si, Gyeonggi-do, Korea 431-080
 t. +82 (0)31 4608 000 f. +82 (0)31 4608 050 <http://www.sgs-lab.co.kr> www.kr.sgs.com/krreslab

Member of the SGS Group (Société Générale de Surveillance)



Test Report No. F690501/LF-CTSAYAA11-16098

Issued Date: May 24, 2011

Page 2 of 8

Test Method:

SGS In-House method-RSTS-SVHC-102-2, 3 and ZLS standard ZEK 01.2-08. Analyzed by ICP-OES, PLM, UV/VIS, LC/MS and GC/MS.

Remarks:

1. The chemical analysis of specified SVHC is performed by means of currently available analytical techniques against the following SVHC related documents published by ECHA: These lists are under evaluation by ECHA and may subject to change in the future.

Refer to: http://echa.europa.eu/chem_data/authorisation_process/candidate_list_table_en.asp

Refer to: http://echa.europa.eu/news/pr/201012/pr_10_26_svhc_candidate_list_20101215_en.asp

2. In accordance with Regulation (EC) No 1907/2006, any producer or importer of articles shall notify ECHA, in accordance with paragraph 2 of Article 7, if a substance meets the criteria in Article 57 and is identified in accordance with Article 59(1) of the Regulation, if (a) the substance is present in those articles in quantities totaling over one tonne per producer or importer per year; and (b) the substance is present in those articles above a concentration of 0.1% weight by weight (w/w).
3. Article 33 of Regulation (EC) No 1907/2006 requires supplier of an article containing a substance meeting the criteria in Article 57 and identified in accordance with Article 59(1) in a concentration above 0.1% weight by weight (w/w) shall provide the recipient of the article with sufficient information, available to the supplier, to allow safe use of the article including, as a minimum, the name of that substance in the Candidate List.
4. If a SVHC is found over the reporting limit, client is suggested to identify the component which contains the SVHC and the exact concentration of the SVHC by requesting further quantitative analysis from the laboratory.

This document is issued by the Company, subject to its General Conditions of Service printed hereon, and also on request or agreement at any time, conditions and specifications, and, for electronic format documents, subject to Terms and Conditions for Electronic Documents as applicable. The Company's sole responsibility is to its Client and the document does not constitute part of a transaction from which all their rights and obligations under the transaction documents. This document cannot be reproduced or copied in full, without prior written approval of the Company. Any unauthorised alteration, copy or falsification of the content or appearance of this document is unlawful and offenders may be prosecuted to the fullest extent of the law. Unless otherwise stated the results shown in this test report are only for the samples tested and such samples are retained for 90 days only.

F052 Version4

SGS Korea Co., Ltd.

322, The O valley, 555-9, Hoggae-dong, Dongan-gu, Anyang-si, Gyeonggi-do, Korea 431-080
t +82 (0)31 4808 000 f +82 (0)31 4808 050 <http://www.sgslab.co.kr> www.kr.sgs.com/brenlab

Member of the SGS Group (Société Générale de Surveillance)



Test Report No. F690501/LF-CTSAYAA11-16098 Issued Date: May 24, 2011 Page 3 of 8

Test Result(s)

Substance Name	CAS number	EC number	Concentration (%)	Reporting Limit (%)	Classification
Alkanes, C10-13, chloro (Short Chain Chlorinated Paraffins)	85535-84-8	287-476-5	N.D.	0.05	PBT
Anthracene	120-12-7	204-371-1	N.D.	0.05	PBT
Benzyl butyl phthalate (BBP)	85-68-7	201-622-7	N.D.	0.05	Toxic to Reproduction Category 2
Bis (2-ethylhexylphthalate) (DEHP)	117-81-7	204-211-0	N.D.	0.05	Toxic to Reproduction Category 2
Bis(tributyltin)oxide*	56-35-9	200-268-0	N.D.	0.05	PBT
Cobalt dichloride*	7646-79-9	231-589-4	N.D.	0.005	Carcinogen Category 2
4,4Diaminodiphenylmethane	101-77-9	202-974-4	N.D.	0.05	Carcinogen Category 2
Diarsenic pentaoxide*	1303-28-2	215-116-9	N.D.	0.005	Carcinogen Category 1
Diarsenic trioxide*	1327-53-3	215-481-4	N.D.	0.005	Carcinogen Category 1
Dibutyl phthalate (DBP)	84-74-2	201-557-4	N.D.	0.05	Toxic to Reproduction Category 2
Hexabromocyclododecane (HBCDD) and all major diastereoisomers identified (α-HBCDD, β-HBCDD, γ-HBCDD)	25637-99-4 and 3194-55-6 (134237-51-7, 134237-50-6, 134237-52-8)	247-148-4 and 221-695-9	N.D.	0.05	PBT
Lead hydrogen arsenate*	7784-40-9	232-064-2	N.D.	0.005	Carcinogen Category 1; Toxic to Reproduction Category 1
Sodium dichromate (Sodium dichromate, dehydrate)	10588-01-9 (7789-12-0)	234-190-3	N.D.	0.005	Carcinogen Category 2; Mutagen Category 2; Toxic to Reproduction Category 2
5-tert-butyl-2,4,6-trinitro-m-xylene (musk xylene)	81-15-2	201-329-4	N.D.	0.05	vPvB
Triethyl arsenate*	15606-95-8	427-700-2	N.D.	0.005	Carcinogen Category 1

This document is issued by the Company subject to its General Conditions of Service printed hereon, available on request or accessible at www.sgslab.com and, for electronic format documents, subject to Terms and Conditions for Electronic Documents at www.sgslab.com. Access to a document by the interaction of a laptop, a terminal or a computer, issued online through any of our services, does not constitute an offer of a contract. The Company's sole responsibility is to its Client and the document does not constitute a contract. All rights and obligations under the interaction documents. This document cannot be reproduced in part or in full, without prior written approval of the Company. Any unauthorized alteration, copy or falsification of the content or appearance of this document is unlawful and offenders may be prosecuted to the fullest extent of the law. Other chemical data not shown in this test report are only in the sampled material and such samples are retained for 90 days only.

F052 Version 4

SGS Korea Co., Ltd.

322, The O valley, 555-9, Hoggae-dong, Dongan-gu, Anyang-si, Gyeonggi-do, Korea 431-080
 t +82 (0)31 4808 000 f +82 (0)31 4808 050 <http://www.sgslab.co.kr> www.kr.sgs.com/kr/en/lab

Member of the SGS Group (Société Générale de Surveillance)



Test Report No. F690501/LF-CTSAYAA11-16098 Issued Date: May 24, 2011 Page 4 of 8

Substance Name	CAS number	EC number	Concentration (%)	Reporting Limit (%)	Classification
Di-isobutyl phthalate(DIBP)	84-69-5	201-553-2	N.D.	0.05	Toxic to Reproduction Category 2
2,4-Dinitrotoluene	121-14-2	204-450-0	N.D.	0.05	Carcinogen Category 2
Tris(2-chloroethyl) phosphate	115-96-8	204-118-5	N.D.	0.05	Toxic to Reproduction Category 2
Anthracene oil	90640-80-5	292-602-7	N.D.	0.05	PBT; vPvB Carcinogen Category 2
Anthracene oil, anthracene paste; distn. Lights	91995-17-4	295-278-5	N.D.	0.05	PBT; vPvB; Carcinogen Category 2; Mutagen Category 2
Anthracene oil, anthracene paste, anthracene fraction	91995-15-2	295-275-9	N.D.	0.05	PBT; vPvB; Carcinogen Category 2; Mutagen Category 2
Anthracene oil, anthracene-low	90640-82-7	292-604-8	N.D.	0.05	PBT; vPvB; Carcinogen Category 2; Mutagen Category 2
Anthracene oil, anthracene paste	90640-81-6	292-603-2	N.D.	0.05	PBT; vPvB; Carcinogen Category 2; Mutagen Category 2
Coal tar pitch, high temperature	65996-93-2	266-028-2	N.D.	0.05	PBT; vPvB; Carcinogen Category 2
Aluminosilicate, Refractory Ceramic Fibres*	-	650-017-00-8 (Index no.)	N.D.	0.005	Carcinogen Category 2
Zirconia Aluminosilicate, Refractory Ceramic Fibres*	-	650-017-00-8 (Index no.)	N.D.	0.005	Carcinogen Category 2
Lead sulfochromate yellow (C.I. Pigment Yellow 34)*	1344-37-2	215-693-7	N.D.	0.005	Carcinogen Category 2; Toxic to Reproduction Category 1
Lead chromate molybdate sulfate red (C.I. Pigment Red 104)*	12656-85-8	235-759-9	N.D.	0.005	Carcinogen Category 2; Toxic to Reproduction Category 1
Lead chromate*	7758-97-6	231-846-0	N.D.	0.005	Carcinogen Category 2; Toxic to Reproduction Category 1
Acrylamide	79-06-01	201-173-7	N.D.	0.05	Carcinogen Category 2; Mutagen Category 2

This document is issued by the Company subject to its General Conditions of Service printed hereon, available on request or accessible at www.sgslab.com and, for electronic format documents, subject to Terms and Conditions for Electronic Documents at www.sgslab.com. Access to a document by the insertion of a label, identification or indicator issued by the Company does not constitute an acknowledgment of the Company's liability in the event of its non-compliance with the terms of the Client's instructions, if any. The Company's sole responsibility is to its Client and the document does not constitute a contract. All rights and obligations under the insertion documents. This document cannot be reproduced in any form, without prior written approval of the Company. Any unauthorised alteration, copy or falsification of the content or appearance of this document is unlawful and offenders may be prosecuted to the fullest extent of the law. Unless otherwise stated the results shown in this test report refer only to the sampled material and such samples are retained for 90 days only.

F052 Version 4

SGS Korea Co., Ltd. 322, The O valley, 555-0, Hoge-dong, Dongan-gu, Anyang-si, Gyeonggi-do, Korea 431-080
 t +82 (0)31 4808 000 f +82 (0)31 4808 050 <http://www.sgslab.co.kr> www.kr.sgs.com/koreanlab

Member of the SGS Group (Société Générale de Surveillance)



Test Report No. F690501/LF-CTSAYAA11-16098 Issued Date: May 24, 2011 Page 5 of 8

Substance Name	CAS number	EC number	Concentration (%)	Reporting Limit (%)	Classification
Boric acid*	10043-35-3 11113-50-1	233-139-2 234-343-4	N.D.	0.005	Toxic to Reproduction Category 2
Disodium tetraborate, anhydrous*	1330-43-4 12179-04-3 1303-96-4	215-540-4	N.D.	0.005	Toxic to Reproduction Category 2
Tetraboron disodium heptaoxide, hydrate*	12267-73-1	235-541-3	N.D.	0.005	Toxic to Reproduction Category 2
Trichloroethylene	79-01-6	201-167-4	N.D.	0.05	Carcinogen Category 2
Sodium chromate *	7775-11-3	231-889-5	N.D.	0.005	Carcinogen Category 2; Mutagen Category 2; Toxic to Reproduction Category 2
Ammonium dichromate *	7789-09-5	232-143-1	N.D.	0.005	Carcinogen Category 2; Mutagen Category 2; Toxic to Reproduction Category 2
Potassium dichromate *	7778-50-9	231-906-6	N.D.	0.005	Carcinogen Category 2; Mutagen Category 2; Toxic to Reproduction Category 2
Potassium chromate *	7789-00-6	232-140-5	N.D.	0.005	Carcinogen Category 2; Mutagen Category 2

This document is issued by the Company subject to its General Conditions of Service printed separately, available on request or accessible at www.sgs.com and www.sgs.com/sgs, and, for electronic format documents, subject to Terms and Conditions for Electronic Documents as available on the Company's website. It is drawn to the attention of the Client that any alteration or modification to the original document, issued on-line, is not valid. Any holder of the document or holder of the information contained therein shall be deemed to have accepted the Company's liability in the event of its dissemination only and within the limit of the Client's instructions, if any. The Company's sole responsibility is to its Client and the document does not constitute a contract. It is the Client's responsibility to ensure that the document is used for its intended purpose and that the Client is aware of the document's content and its implications. This document cannot be reproduced or used in full, without prior written approval of the Company. Any unauthorized alteration, forgery or falsification of the content or appearance of this document is unlawful and offenders may be prosecuted to the fullest extent of the law. Unless otherwise stated the results shown in this report are only in the original issued and such samples are referred to as 'dry' only.

F052 Version4

SGS Korea Co., Ltd.

322, The O valley, 555-9, Hoggae-dong, Dongan-gu, Anyang-si, Gyeonggi-do, Korea 431-080
t +82 (0)31 4808 000 f +82 (0)31 4808 050 <http://www.sgs.com> www.kr.sgs.com sgs@sgs.com

Member of the SGS Group (Société Générale de Surveillance)



Test Report No. F690501/LF-CTSAYAA11-16098 Issued Date: May 24, 2011 Page 6 of 8

Substance Name	CAS number	EC number	Concentration (%)	Reporting Limit (%)	Classification
Cobalt(II) sulphate *	10124-43-3	233-334-2	N.D.	0.005	Carcinogen Category 2; Toxic to Reproduction Category 2
Cobalt(II) dinitrate *	10141-05-6	233-402-1	N.D.	0.005	Carcinogen Category 2; Toxic to Reproduction Category 2
Cobalt(II) carbonate *	513-79-1	208-169-4	N.D.	0.005	Carcinogen Category 2; Toxic to Reproduction Category 2
Cobalt(II) diacetate *	71-48-7	200-755-8	N.D.	0.005	Carcinogen Category 2; Toxic to Reproduction Category 2
2-Methoxyethanol	109-86-4	203-713-7	N.D.	0.05	Toxic to Reproduction Category 2
2-Ethoxyethanol	110-80-5	203-804-1	N.D.	0.05	Toxic to Reproduction Category 2
Chromium trioxide ^	1333-82-0	215-607-8	N.D.	0.005	Carcinogen Category 1; Mutagen Category 2
Acids generated from chromium trioxide and their oligomers:					
Chromic acid	7738-94-5	231-801-5	N.D.	0.005	Carcinogen Category 2
Dichromic acid	13530-68-2	236-881-5			
Oligomers of chromic acid and dichromic acid ^	-	-			

This document is issued by the Company subject to its General Conditions of Service printed overleaf, available on request or accessible at www.sgs.com and, for electronic format documents, subject to Terms and Conditions for Electronic Documents as available on the Company's Intranet or is drawn to the attention of the Client. Any holder of the document or holder of the information contained herein releases the Company's liability in the event of its dissemination copy and within the limit of the Client's instructions, if any. The Company's sole responsibility is to its Client and the document does not constitute a transaction from which any right and obligation under the transaction documents. This document cannot be reproduced or used in full without prior written approval of the Company. Any unauthorized alteration, forgery or falsification of the content or appearance of this document is unlawful and offenders may be prosecuted to the fullest extent of the law. Unless otherwise stated the results shown in this report refer only to the samples tested and such samples are referred to as 'docs' only.

F052 Version4

SGS Korea Co., Ltd.

322, The C valley, 555-9, Hoggae-dong, Dongan-gu, Anyang-si, Gyeonggi-do, Korea 431-080
t +82 (0)31 4808 000 f +82 (0)31 4808 050 <http://www.sgs.com> www.kr.sgs.com kr@sgs.com

Member of the SGS Group (Société Générale de Surveillance)



Test Report No. F690501/LF-CTSAYAA11-16098 Issued Date: May 24, 2011 Page 7 of 8

Note:

1. RL = Reporting Limit
2. ND = Not detected (lower than RL)

NA = Not applicable for respective material type.

The submitted sample was found to contain significant amount of specific element(s) of SVHC. Upon further test verification and also information provided from client, the possibility that the element(s) content originate from SVHC is very unlikely, even though their presence cannot be exclude entirely. It may be assumed that the detected element(s) have a non-SVHC source.

- 3.. *.The test result is based on the calculation of selected element(s) / marker(s) and to the worst-case scenario. For detail information, please refer to the SGS REACH website: www.reach.sgs.com/substance-of-very-high-concern-analysis-information-page.htm

* Calculated concentration of boric acid, disodium tetraborate, anhydrous and tetraboron disodium heptaoxide, hydrate are based on the total/water extractive boron by ICP-OES. Calculated concentrations of cobalt(II) sulphate, cobalt(II) dinitrate, cobalt(II) carbonate, cobalt(II) diacetate are based on the total/water extractive cobalt by ICP-OES.

^ Calculated concentrations of chromium trioxide, chromic acid and dichromic acid are based on the identified chromium(VI) by UV-Vis.

4. Test result of anthracene oil and coal tar are calculated as per selected identifiers of the SVHC. The value is reported in aggregate per anthracene oil or coal tar and based on the worst-case scenario.
5. 0.1% (w/w) = 1,000 ppm = 1,000 mg/kg



*** End of Report ***

This document is issued by the Company subject to its General Conditions of Service printed overleaf, available on request or accessible at www.sgs.com and, for electronic format documents, subject to Terms and Conditions for Electronic Documents as available on the Company's website. It is drawn to the attention of the Client that any further of the document or further information should be obtained from the Company's office in the area of its issuance only and within the limits of Client's instructions, if any. The Company's sole responsibility is to its Client and this document does not constitute a transaction from which any right and obligation under the transaction documents. This document cannot be reproduced in part or in full without prior written approval of the Company. Any unauthorized circulation, copying or publication of the content or appearance of this document is unlawful and offenders may be prosecuted to the fullest extent of the law. Unless otherwise stated the results shown in this report refer only to the samples tested and such samples are referred to 'no. diggs' only.

F062 Version4

SGS Korea Co., Ltd.

322, The O valley, 555-0, Hoggia-dong, Dongan-gu, Anyang-si, Gyeonggi-do, Korea 431-080
t +82 (0)31 4808 000 f +82 (0)31 4808 050 <http://www.sgslab.co.kr> www.kr.sgs.com/kr/en/lab

Member of the SGS Group (Société Générale de Surveillance)



Test Report No. F690501/LF-CTSAYAA11-16098 Issued Date: May 24, 2011 Page 8 of 8

Appendix A

Classification	Definition under 67/548/EEC and Regulation (EC) No 1907/2006
Carcinogen Category 1:	<u>Substances known to be carcinogenic to man.</u> There is sufficient evidence to establish a causal association between human exposure to a substance and the development of cancer.
Carcinogen Category 2:	<u>Substances which should be regarded as if they are carcinogenic to man.</u> There is sufficient evidence to provide a strong presumption that human exposure to a substance may result in the development of cancer. Generally on the basis of: - appropriate long-term animal studies - other relevant information.
Mutagen Category 1:	<u>Substances known to be mutagenic to man.</u> There is sufficient evidence to establish a causal association between human exposure to a substance and heritable genetic damage.
Mutagen Category 2:	<u>Substances which should be regarded as if they are mutagenic to man.</u> There is sufficient evidence to provide a strong presumption that human exposure to the substance may result in the development of heritable genetic damage, generally on the basis of: - appropriate animal studies, - other relevant information.
Toxic to Reproduction Category 1:	<u>Substances known to impair fertility in humans.</u> There is sufficient evidence to establish a causal relationship between human exposure to the substance and impaired fertility. <u>Substances known to cause developmental toxicity in humans.</u> There is sufficient evidence to establish a causal relationship between human exposure to the substance and subsequent developmental toxic effects in the progeny.
Toxic to Reproduction Category 2:	<u>Substances which should be regarded as if they impair fertility in humans.</u> There is sufficient evidence to provide a strong presumption that human exposure to the substance may result in impaired fertility on the basis of: - clear evidence in animal studies of impaired fertility in the absence of toxic effects, or, evidence of impaired fertility occurring at around the same dose levels as other toxic effects but which is not a secondary nonspecific consequence of the other toxic effects, - other relevant information. <u>Substances which should be regarded as if they cause developmental toxicity to humans.</u> There is sufficient evidence to provide a strong presumption that human exposure to the substance may result in developmental toxicity, generally on the basis of: - clear results in appropriate animal studies where effects have been observed in the absence of signs of marked maternal toxicity, or at around the same dose levels as other toxic effects but which are not a secondary non-specific consequence of the other toxic effects, - other relevant information.
PBT & vPvB:	Substances which are persistent, bioaccumulative and toxic (PBT) or very persistent and very bioaccumulative (vPvB) pose a particular challenge to the chemicals safety management. For these substances a "safe" concentration in the environment cannot be established with sufficient reliability.

This document is issued by the Company subject to its General Conditions of Service printed overleaf, available on request or accessible at www.sgslab.com and, for electronic format documents, subject to Terms and Conditions for Electronic Documents as available on the Company's website or is drawn to the attention of the Client. Any holder of the document or holder of the information contained herein releases the Company's liability in the event of its dissemination copy and within the limit of the Client's instructions, if any. The Company's sole responsibility is to its Client and the document does not constitute parties to a transaction from which all their rights and obligations under the transaction document. This document cannot be reproduced or used in full, without prior written approval of the Company. Any unauthorized alteration, forgery or falsification of the content or appearance of this document is unlawful and offenders may be prosecuted to the fullest extent of the law. Unless otherwise stated the results shown in this report are only in the sample tested and such samples are referred to 'no. dig. only'.

F052 Version4

SGS Korea Co., Ltd.

322, The O valley, 555-9, Hoggae-dong, Dongan-gu, Anyang-si, Gyeonggi-do, Korea 431-080
t +82 (0)31 4808 000 f +82 (0)31 4808 050 <http://www.sgslab.co.kr> www.kr.sgs.com/breenlab

Member of the SGS Group (Société Générale de Surveillance)

Revision History (Model:SPMWHT221MD5WAQ0S0)

Date	Revision History	Writer	
		Drawn	Approved
2011.03.07	New Version	S.B Yun	Y.H Song
2011.07.15	Maximum Rating 100mA → 150mA Modification of Characteristics Graph	T.J Kim	Y.H Song
2011.08.12	Luminous Flux Bin change and addition	T.J Kim	Y.H Song