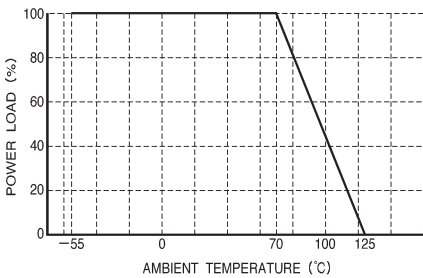

Thick film rectangular MCR01 (1005 size: 1 / 16W)

●Features

- 1) Extremely small and light
Area ratio is 60% smaller than that of chip 1608, while weight ratio has been cut 75%.
- 2) Highly reliable chip resistor
Ruthenium oxide dielectric offers superior resistance to the elements.
- 3) Electrodes not corroded by soldering
Thick film makes the electrodes very strong.
- 4) Flat surface further facilitates mounting
Mounting can also be automated.
- 5) ROHM resistors have approved ISO-9001 certification.
Design and specifications are subject to change without notice. Carefully check the specification sheet supplied with the product before using or ordering it.

●Ratings

Item	Conditions	Specifications	
Rated power	Power must be derated according to the power derating curve in Figure 1 when ambient temperature exceeds 70°C. 	0.063W (1 / 16W) at 70°C	
Rated voltage	The voltage rating is calculated by the following equation. If the value obtained exceeds the maximum operating voltage, the voltage rating is equal to the maximum operating voltage. $E = \sqrt{P \times R}$ E: Rated voltage (V) P: Rated power (W) R: Nominal resistance (Ω)	Max. operating voltage	50V
		Max. overload voltage	100V
		Max. intermittent overload voltage	100V
Nominal resistance	See Table 1.		
Operating temperature		-55°C to +125°C	

Jumper type

Resistance	Max. 50mΩ
Rated current	0.5A
Peak current	1.5A
Operating temperature	-55°C to +125°C

Table 1

Resistance tolerance	Resistance range (Ω)	Resistance temperature coefficient (ppm / °C)
F (±1%)	100 ≤ R ≤ 2.2M (E24)	±250
J (±5%)	2.2 ≤ R < 10 (E24)	+500 / -250
	10 ≤ R ≤ 3.3M (E24)	±250

●Before using components in circuits where they will be exposed to transients such as pulse loads (short-duration, high-level loads), be certain to evaluate the component in the mounted state. In addition, the reliability and performance of this component cannot be guaranteed if it is used with a steady state voltage that is greater than its rated voltage.

● Characteristics

Characteristics	Specifications		Test method (JIS C 5202)
	Chip resistance	Jumper type	
DC resistance	F : $\pm 1\%$ J : $\pm 5\%$	Max. 50m Ω	JIS C 5202 5.1 Applied voltage: A
Resistance temperature characteristics	See Table 1 .		JIS C 5202 5.2 Test conditions: +25 / -55 / +25 / +125°C
Short time overload	$\pm (2.0\% + 0.1 \Omega)$	Max. 50m Ω	JIS C 5202 5.5 Rated voltage (current) : $\times 2.5$, 5s. Maximum overload voltage: 100V
Intermittent overload	$\pm (5.0\% + 0.1 \Omega)$	Max. 50m Ω	JIS C 5202 5.8 Rated voltage (current) : $\times 2.5$ (1s: ON - 25s: OFF) $\times 10,000$ cyc.
Terminal strength (against bending of circuit board)	$\pm (1.0\% + 0.05 \Omega)$ There must be no mechanical damage.	Max. 50m Ω	JIS C 5202 6.1
Resistance to soldering heat	$\pm (1.0\% + 0.05 \Omega)$ Outside must not be noticeably damaged.	Max. 50m Ω	JIS C 5202 6.4 Soldering conditions: 260 $\pm 5^\circ\text{C}$ Soldering time: 10 ± 1 s.
Solderability	95% of terminal surface must be covered by new soldering, and there must be no soldering corrosion.		JIS C 5202 6.5 Rosin methanol: (25%WT) Soldering conditions: 235 $\pm 5^\circ\text{C}$ Soldering time: 2.0 ± 0.5 s.
Resistance to dry heat	$\pm (3.0\% + 0.1 \Omega)$	Max. 100m Ω	JIS C 5202 7.2 125°C Test time: 1,000 to 1,048 hrs.
Endurance (rated load)	$\pm (3.0\% + 0.1 \Omega)$	Max. 100m Ω	JIS C 5202 7.10 Rated voltage (current), 70°C 1.5h: ON - 0.5h: OFF Test time: 1,000 to 1,048 hrs.
Endurance (under load in damp environment)	$\pm (3.0\% + 0.1 \Omega)$	Max. 100m Ω	JIS C 5202 7.9 Rated voltage (current), 60°C, 95%RH 1.5h: ON - 0.5h: OFF Test time: 1,000 to 1,048 hrs.
Resistance to humidity (steady state)	$\pm (3.0\% + 0.1 \Omega)$	Max. 100m Ω	JIS C 5202 7.5 85°C, 85%RH Test time: 1,000 to 1,048 hrs.
Temperature cycling	$\pm (1.0\% + 0.05 \Omega)$	Max. 50m Ω	JIS C 5202 7.4 Test temperature: -55°C to +125°C 100cyc.
Resistance to solvents	$\pm (0.5\% + 0.05 \Omega)$	Max. 50m Ω	JIS C 5202 6.9 Room temperature, static immersion, 1 min. Solvent: Isopropyl alcohol

● External dimensions (Units: mm)

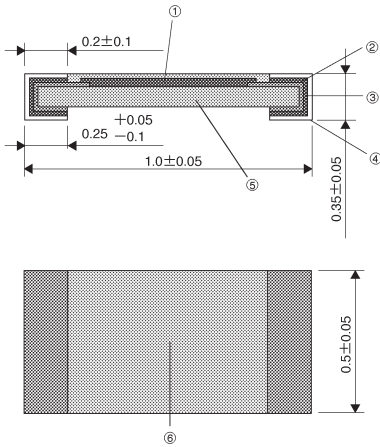

No.	Material
①	Thick dielectric glaze of ruthenium (only silver used for jumper)
②	Thick film of palladium-silver for primary electrode
③	Nickel-coated secondary electrode
④	External electrode coated with tin and lead
⑤	Alumina substrate
⑥	Overcoating

●Packaging

Reel

Label

EIAJ ET-7001 compliant

(Units : mm)

A	B	C	D
$\phi 180 \begin{smallmatrix} 0 \\ -3 \end{smallmatrix}$	$\phi 60 \begin{smallmatrix} +1 \\ 0 \end{smallmatrix}$	9 ± 0.3	$\phi 13 \pm 0.2$

Taping

(Units : mm)

W	F	E	A0	B0
8.0 ± 0.3	3.5 ± 0.05	1.75 ± 0.1	0.7 ± 0.1	1.2 ± 0.1
D0	P0	P1	P2	T2
$\phi 1.5 \begin{smallmatrix} +0.1 \\ 0 \end{smallmatrix}$	4.0 ± 0.1	2.0 ± 0.1	2.0 ± 0.05	Max. 1.1

Bulk case

(Units : mm)

EIAJ ET-7201A compliant

●Product designation

Part No.

M	C	R	0	1		M	Z	S		J
---	---	---	---	---	--	---	---	---	--	---

3-digit or 4-digit IEC coding system

Nominal resistance

--	--	--	--

Packaging / Processing specifications

Part No.	Code	Packaging style	Standard ordering unit(pcs)	Shipped to
MCR01	MZS	Paper tape	10,000	World wide
	PZSI	Bulk case	50,000	World wide

Resistance tolerance

F	$\pm 1\%$	J	$\pm 5\%$
Specify "J" for jumper also.			

● Dimensions

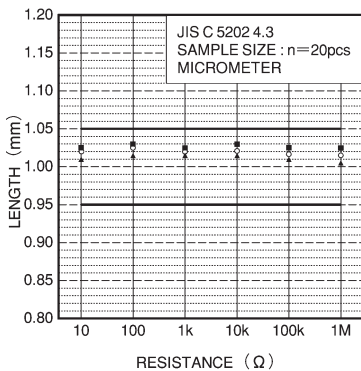

Fig.2 Dimensions (length)

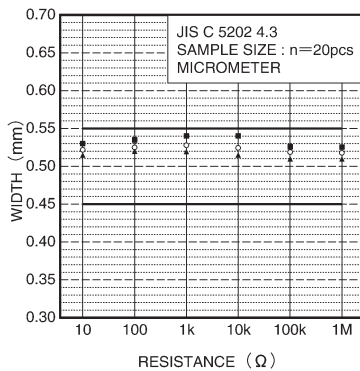

Fig.3 Dimensions (width)

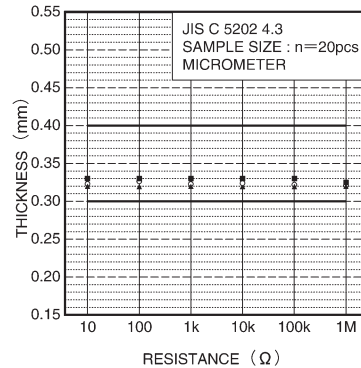

Fig.4 Dimensions (thickness)

● Electrical characteristics

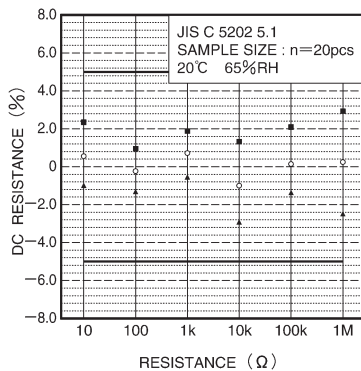

Fig.5 DC resistance

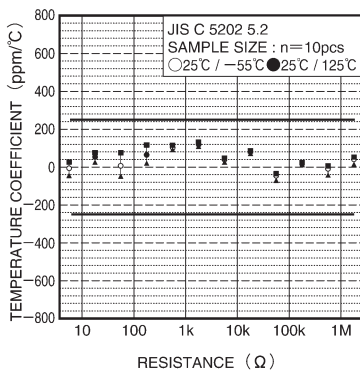

Fig.6 Resistance temperature characteristics

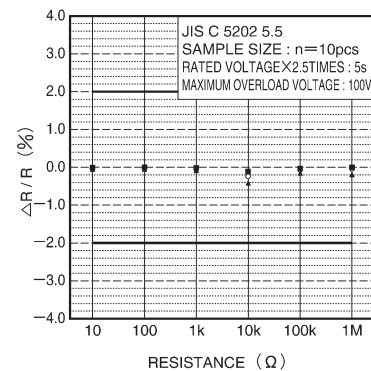

Fig.7 Short time overload

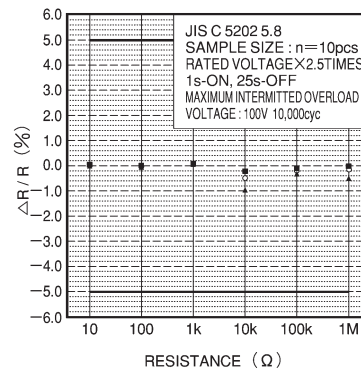

Fig.8 Intermittent overload

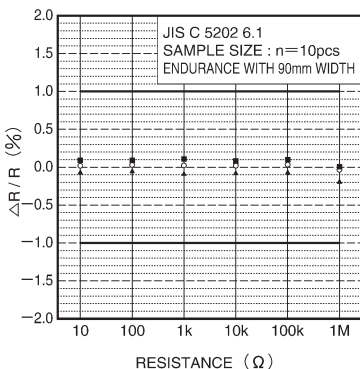

Fig.9 terminal strength (bending strength characteristics)

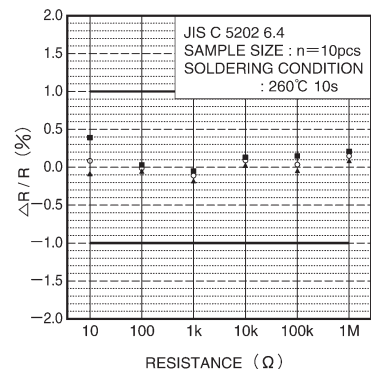

Fig.10 Resistance to soldering heat

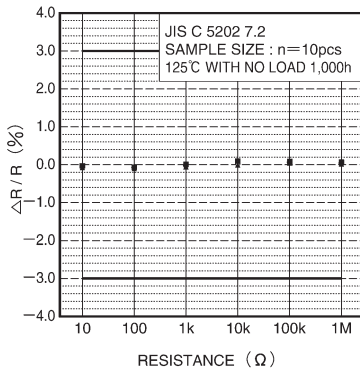

Fig.11 Resistance to dry heat

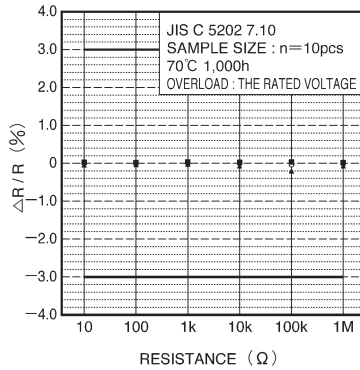

Fig.12 Endurance (rated load)

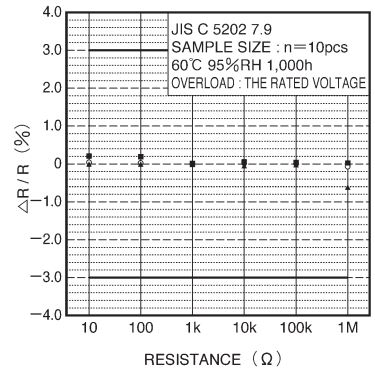
Fig.13 Endurance
(under load in
damp environment)Fig.14 Humidity resistance
(steady state)

Fig.15 Temperature cycling

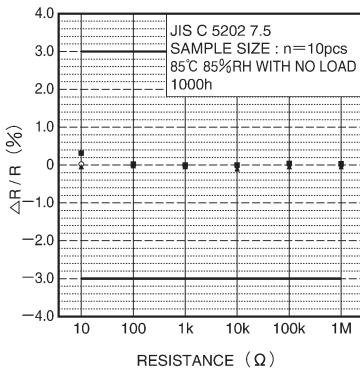
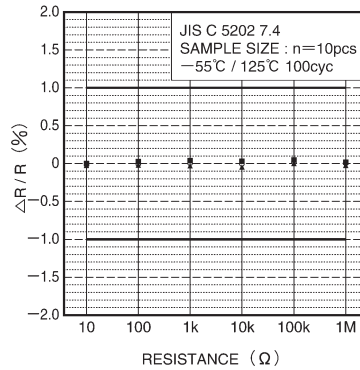
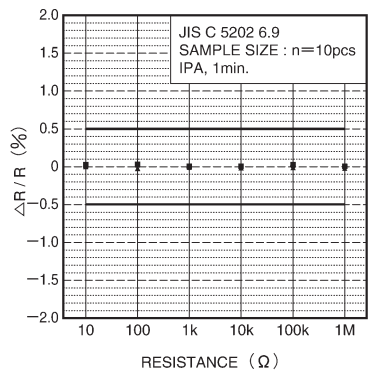

Fig.16 Resistance to solvents