

32-bit SuperH™ SH-2 and SH-2A Controllers for Embedded Systems



Factory Automation

Medical

Networking/Peripherals

Automotive

Entertainment

Home Appliances

SuperH SH-2 and SH-2A Controllers



Scalable 32-bit RISC controllers for feature-rich embedded applications

The popular Renesas SuperH™ SH-2 and SH-2A based 32-bit product line encompasses both microcontrollers (MCUs) and microprocessors (MPUs).

- ▶ MCUs include embedded flash and RAM for single-chip real-time embedded control systems
- ▶ MPUs include on-chip cache, RAM, connectivity and multimedia peripherals for digital audio and display control applications

Today's SuperH MCU/MPU lineup builds on the SuperH core first introduced in 1993 and incorporates advanced design and process technology. It also enjoys a world-class development tool ecosystem.



	General Embedded Systems	CAN	USB	Ethernet	Audio, LCD Controller
200MHz		SH7216	SH7216	SH7216	
160MHz	SH7211				
144MHz		SH7264 SH7262	SH7670 SH7264 SH7262	SH7670	SH7264 SH7262
100MHz	SH7243	SH7216 SH7286	SH7216 SH7286 SH7285	SH7216	
80MHz	SH7080	SH7147 SH7137			
50MHz	SH/Tiny SH7125 SH/Tiny SH7124				







MCU: SH-2 Core



MCU: SH-2A Superscalar Core



MCU: SH-2A Superscalar Core with FPU



MPU: SH-2A Superscalar Core with FPU

Superscalar Core with 2 Instructions/clock & Independent Floating Point Unit

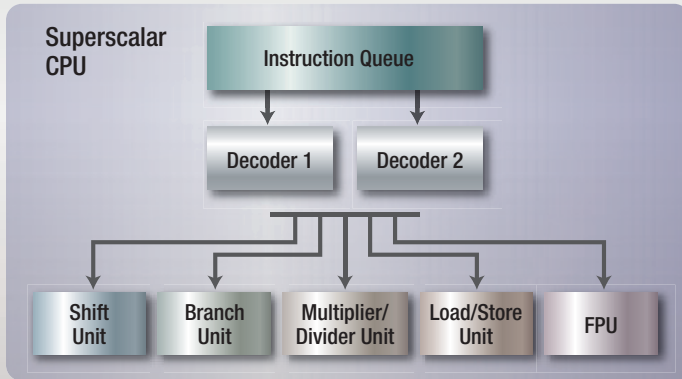

- ▶ Five stage, dual-issue pipeline
- ▶ Up to 2.4 DMIPS/MHz performance
- ▶ Multiple independent execution units
- ▶ Independent FPU pipeline
- ▶ Superscalar core and FPU are available in select MCUs and all MPUs

Industry's Fastest On-chip Flash Memory

- ▶ SuperH MCUs include up to 100MHz single-cycle flash memory
- ▶ Allows higher performance at maximum frequency
- ▶ Eliminates the need to execute from RAM, thus freeing more RAM for data variables and lowering the device cost

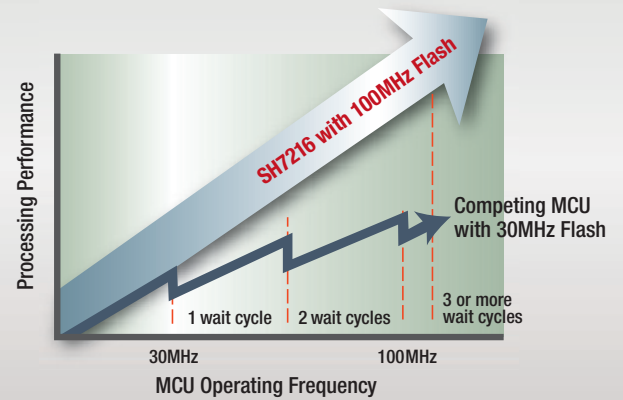

Fast Interrupt Response with 16 Banks of Registers

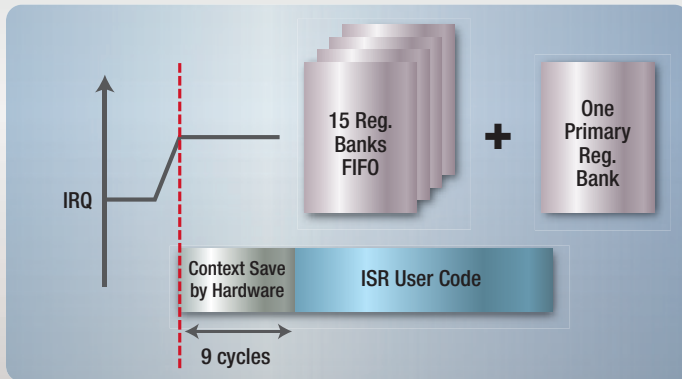

- ▶ Only nine cycles from IRQ event to beginning of ISR code
- ▶ Hardware automatically saves the context in register banks FIFO
- ▶ Available in SH-2A based MCUs and MPUs

Extensive Built-in Peripheral Functions

- ▶ The high level of integration achieved by SuperH MCUs and MPUs reduces component counts, easing the packaging of compact embedded systems and reducing cost

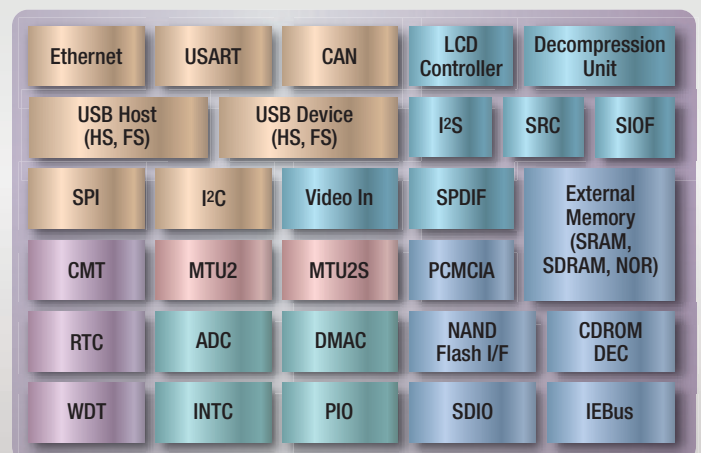

See back page for full peripheral names

Illustrating the Design Potential and Versatility of SuperH MCUs and MPUs



SuperH devices include a wide range of features to enable a broad span of embedded systems. Here are four representative application examples.

Factory Automation

- ▶ Up to 480 DMIPS performance and 1MB flash enable advanced control algorithms & multiple connectivity interfaces
- ▶ Dual motor-control timers and special ADC module with multiple S/H units can drive any type of motor
- ▶ Second ADC module can interface with a variety of sensors
- ▶ Integrated Ethernet, CAN and USB
- ▶ BGO Data Flash allows CPU to continue to execute while Write operation is in progress

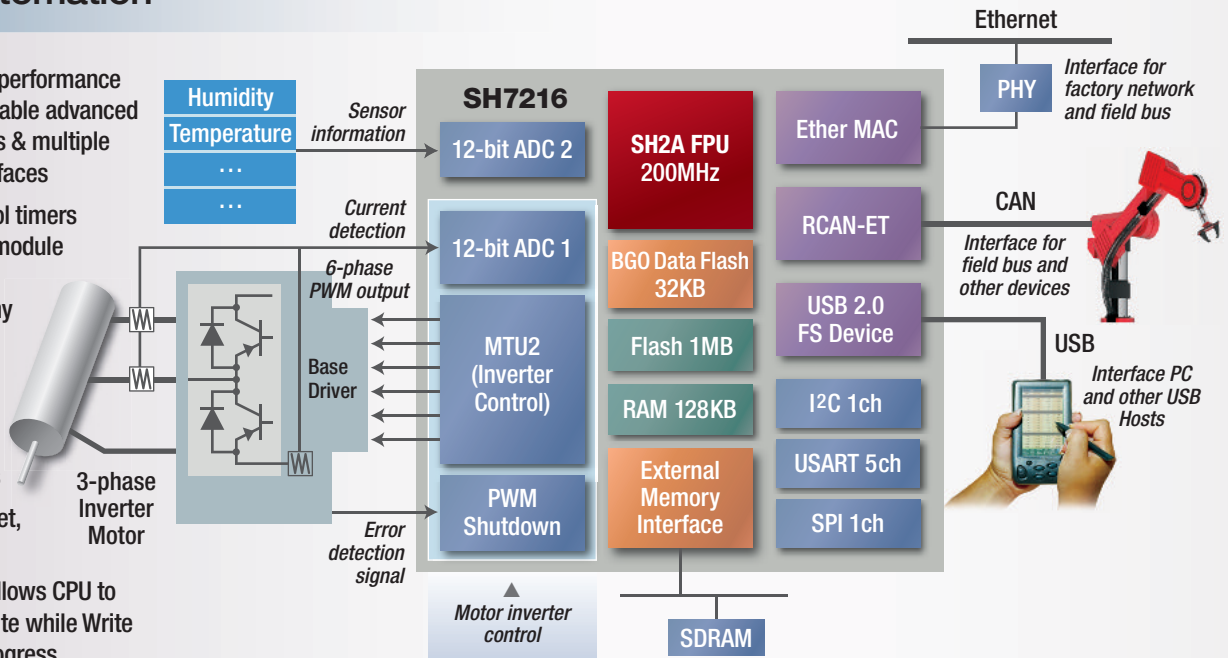

Outdoor Heat Pump

- ▶ Control two motors simultaneously
- ▶ Automatic dead-time insertion in PWM outputs
- ▶ Hardware-based automatic PWM shutdown upon fault input
- ▶ Dual ADC modules with multiple S/H units
- ▶ Programmable ADC trigger to enable one-shunt current detection method
- ▶ Multiple serial interfaces

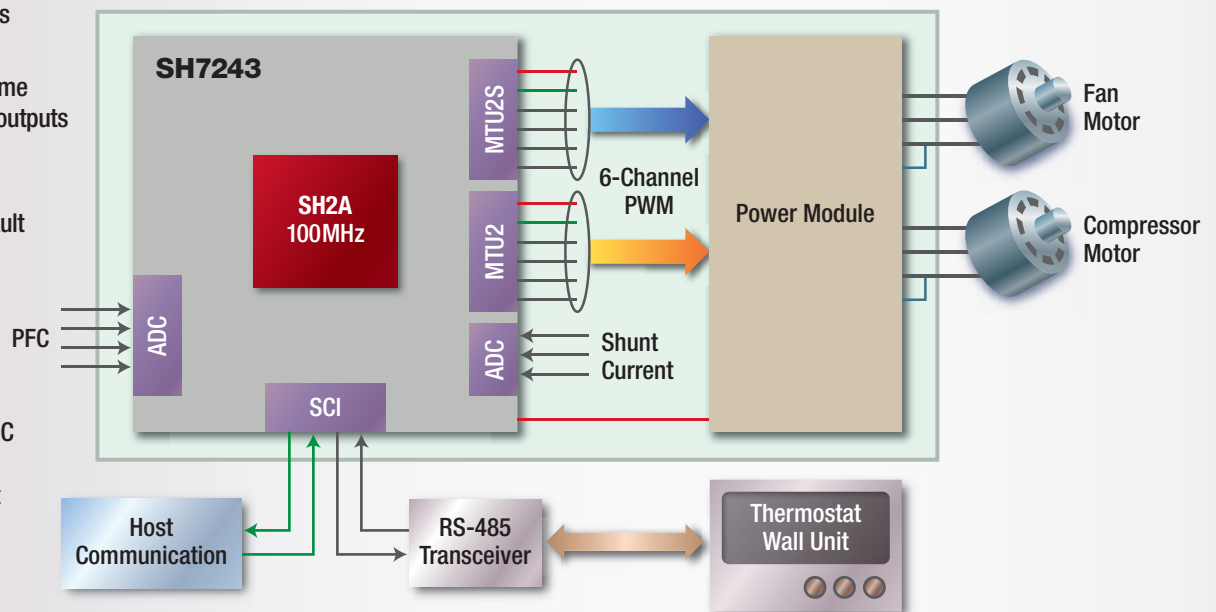

Audio/Video Application

- ▶ Display Controller with Alpha blending and Chroma-keying
- ▶ 1MB of on-chip SRAM for Program Space and Frame Buffer
- ▶ Serial and Parallel Memory boot options
- ▶ BT.656 Video input

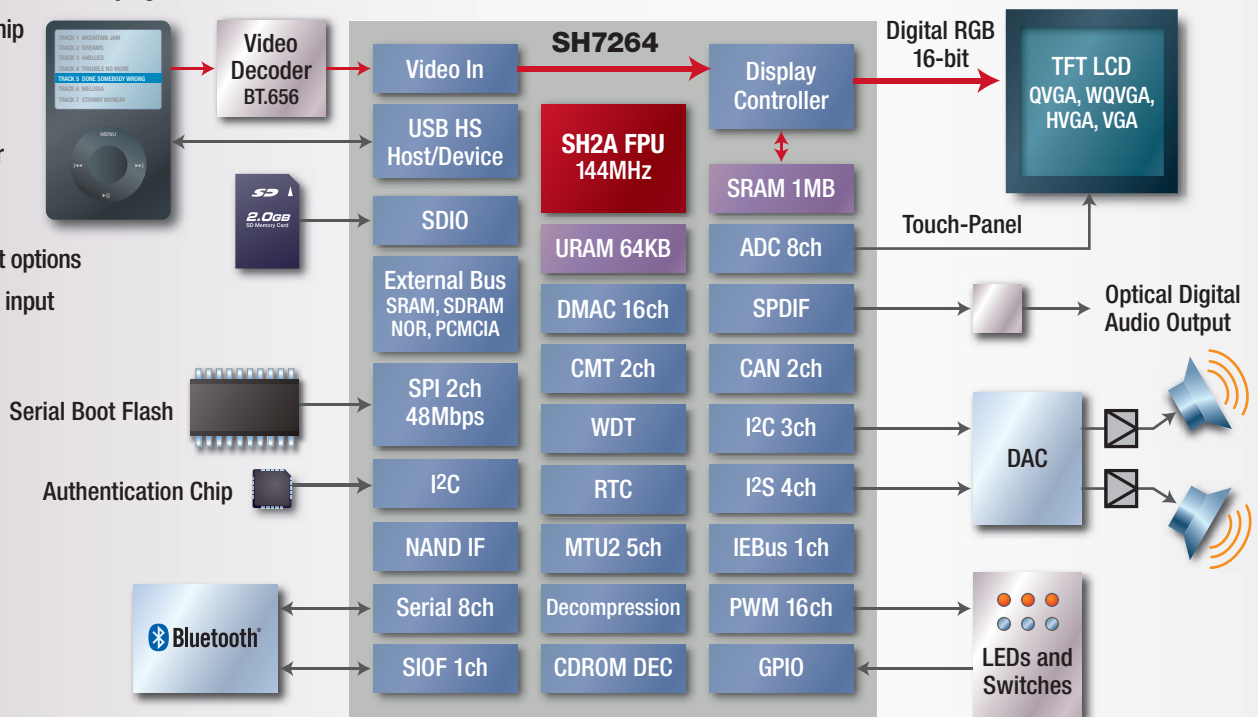

Medical Diagnostic System

- ▶ Achieve efficient motor control using SH7125 in small package and 65 DMIPS performance
- ▶ Perform both signal-processing and real-time control using SH7211 or SH7216
- ▶ Add connectivity and host interface using SH7286 or SH7216
- ▶ Implement advanced graphical interface using SH7264

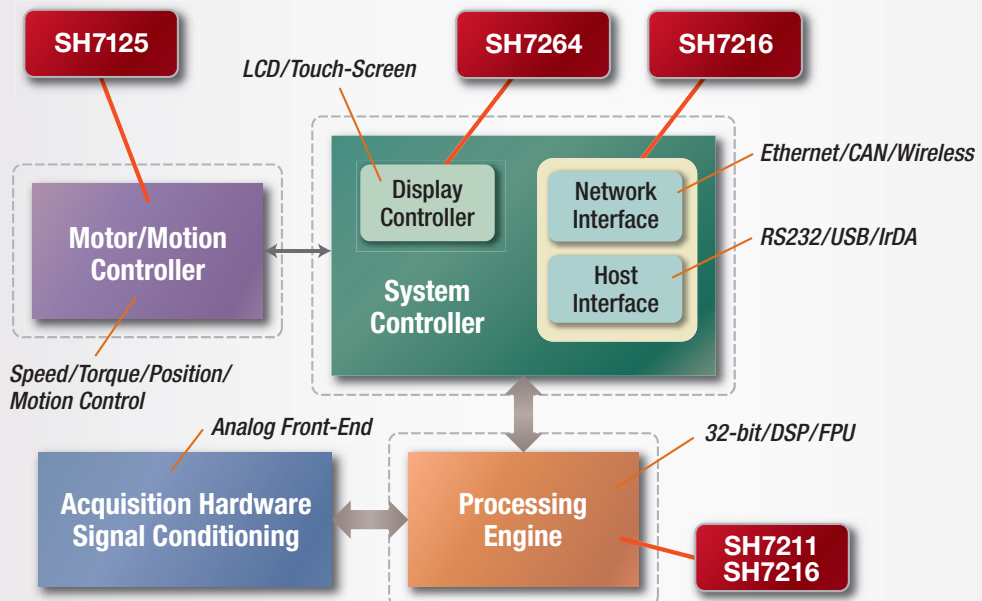

Renesas Hardware and Software Tools

HEW – The Renesas Integrated Development Environment

The High-performance Embedded Workshop (HEW) is a state-of-the-art development and debugging environment with C/C++ compiler, debugger, editor, etc. It includes advanced features such as function browser, virtual desktop, and stack trace, to list just a few. A 256KB compiler evaluation version is available for free.

Project Manager

- Graphical control of compiler/linker options
- Function browser
- Drag-and-drop code templates
- Built-in (or external) project make

Output Window

- Shows messages from build and find-in-files
- Linked to source in editor
- Version-control log

Built-in Editor

- Syntax sensitive coloring
- Multiple files open at once
- Source-level debugging

Full Bus Trace

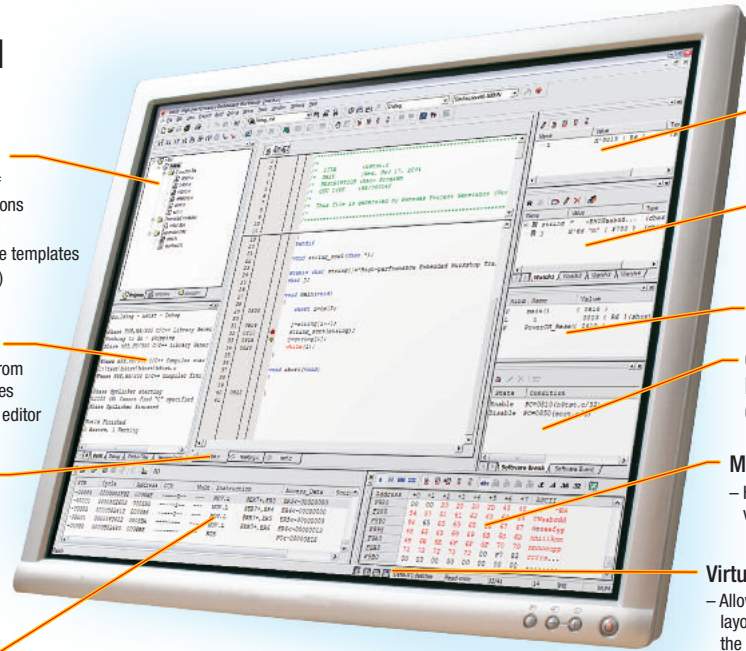

Local Variable Watch

C/C++ Variable Watch

Stack Trace

Complex Break Conditions

Memory View
- Highlights changed values

Virtual Desktop
- Allows multiple screen layouts to be recalled at the click of a button

Renesas Emulators

Renesas offers a full range of emulation products, from the low-cost E10a on-chip debug emulator to our powerful E200F, a full in-circuit emulation system. The E10a emulator provides several hardware instruction and data breakpoints and a trace port. The E200F provides unlimited hardware breakpoints with real-time profiling capability.

www.america.renesas.com/tools



▶ E10a On-Chip Emulator



▶ E200F In-Circuit Emulation System

Renesas Starter Kit (RSK)

A Renesas Starter Kit is a cost effective tool to get started with SuperH MCUs. It includes board, debugger, power supply and CD-ROM in one box.

SH/Tiny	R0K571242S001BE
SH7285/86	R0K572867S000BE
SH7137	R0K571374S000BE
SH7670	R0K576700S000BE
SH7262	R0K572643S000BE
SH7216	R0K572167S000BE*

* Available in Q1, 2010



www.america.renesas.com/tools

Motor Control Platform

The Renesas Motor Control Platform is a modular, versatile system that supports a wide range of motor types. The complete reference design is available on the Renesas web site.

- ▶ Up to 200VAC/20A
- ▶ Supports DCCT or 1-shunt current sensors
- ▶ Sensored and sensorless vector control algorithms

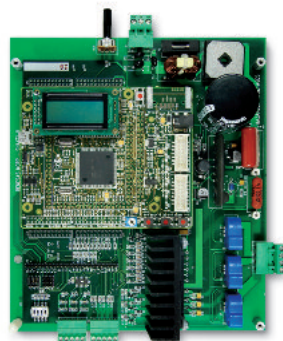

www.america.renesas.com/motorcontrol

Sample Codes, Libraries and Algorithms

Visit the Renesas web site for FREE sample code, along with motor control algorithms and libraries in source form for CAN, USB and Ethernet.



▶ The SH7264 Media Player Reference Development System

www.america.renesas.com/SWLibrary

Third-Party Support

System development products and services from a worldwide community of third-party experts

Customers who choose SuperH MCUs and MPUs can obtain system development assistance not only from Renesas, but also from our technology partners – a large group of third-party experts around the globe.

Many different operating systems, middleware packages and other products and services are available to simplify, speed-up, and reduce the engineering risk of new embedded system designs.

Micrium

For The Way Engineers Work

www.micrium.com

RTOS and Tools



FREE GNU Tools

www.kpitgntools.com

IDE, Compiler and Debugger

- ▶ SH Toolchain for Windows & Linux
- ▶ HEW integration for Windows
- ▶ Eclipse IDE for Windows & Linux



www.cmx.com

RTOS and Middleware

- ▶ CMX-RTX
- ▶ CMX-MicroNet and CMX-TCP/IP
- ▶ CMX-USB
- ▶ CMX-FFS



www.segger.com

RTOS and Middleware

- ▶ embOS
- ▶ embOS/IP
- ▶ emUSB
- ▶ emFile
- ▶ emWin



www.swellsoftware.com

PEG™ Family of Embedded GUI Software

- PEG Pro™
- PEG+™
- C/PEG+™



www.iar.com

IDE, Compiler and Debuggers

- ▶ IAR Embedded Workbench
- ▶ Hardware Debug Probe



www.rtos.com

RTOS and Middleware



The Renesas Ecosystem

A network of programs for your support www.Renesas.com/Ecosystem

Alliance Partners

▶ The Alliance Partner Program allows you to connect instantly with hundreds of qualified design consulting and contracting professionals.
www.America.Renesas.com/Alliance



Renesas Interactive

▶ Gain the technical knowledge you need. Research and learn at your own pace, where you want, when you want, for free.
www.RenesasInteractive.com



My Renesas

▶ Customize your data retrieval needs on the Renesas web site. You'll receive updates on the products that you're interested in.
www.America.Renesas.com/MyRenesas



RenesasRulz

▶ A forum and gathering place for technical information and those who use Renesas MCUs and MPUs.
www.RenesasRulz.com



Renesas University

▶ For educators and students. Teach with professional grade tools. Learn MCUs with a modern architecture.
www.RenesasUniversity.com



Samples

▶ Get a first-hand look at our products. Let us know your needs, and we'll get some samples out to you.
www.America.Renesas.com/Samples



SH2 & SH-2A Family – Key Products



These devices are recommended for new system designs. Visit our web site for a complete listing.

Series	Ordering Part Number	MHz	Flash (KB)	RAM (KB)	Cache	Vcc (V)	FPU	External Memory	Ethernet MAC	USB Host	USB Device	CAN	USART	SPI	I2C	Timers	Watchdog Timer	ADC (Channels)	DAC	GPIO	Additional Features	Temperature Range (°C)	Package (mm)			
MCU	SH7216	R5F72145ADFA#V0	200	512	64	-	3.3	N	Y	N	FS	Y	5	1	1	MTU2, MTU2S, CMT	Y	12-bit (8)	-	110	8 DMA Channels, DTC, 32KB BGO Data Flash, HW PWM Shutdown, On-chip Debug & Trace	-40 to +85	176QFP, 20x20x0.4			
		R5F72147ADFA#V0		1024	128																					
		R5F72145GDFA#V0	100	512	64																					
		R5F72147GDFA#V0		1024	128																					
		R5F72165ADFA#V0	200	512	64																					
		R5F72167ADFA#V0		1024	128																					
		R5F72165GDFA#V0	100	512	64																					
	R5F72167GDFA#V0	1024		128																						
	SH7280	R5F72865D100FA#U0	100	512	24	-	3.3	N	SRAM, SDRAM, NOR	N	N	FS	Y	5	1	1	MTU2, MTU2S, CMT	Y	12-bit (12)	2	113	8 DMA Channels, DTC, HW PWM Shutdown, On-chip Debug & Trace	-40 to +85	176QFP, 24x24x0.5		
		R5F72866D100FA#U0		768	32																					
		R5F72867D100FA#U0		1024	32																					
		R5F72855D100FP#U0		512	24																					
		R5F72856D100FP#U0		768	32																					
	SH7243	R5F72433D100FP#U0	100	128	8	-	3.3	N	SRAM, SDRAM, NOR	N	N	N	N	5	-	-	MTU2, MTU2S, CMT	Y	12-bit (8)	-	71	DMA Channels, DTC, HW PWM Shutdown, On-chip Debug & Trace	-40 to +85	100QFP, 14x14x0.5		
		R5F72434D100FP#U0		256	12																					
	SH7211	DF72115D160FPV	160	512	32	-	1.5, 3.3	N	SRAM, SDRAM, NOR	N	N	N	N	4	-	1	MTU2, MTU2S, CMT	Y	12-bit (8)	-	75	8 DMA Channels, HW PWM Shutdown, On-chip Debug & Trace	-40 to +85	144QFP, 20x20x0.5		
	SH7137	DF71374AD80FPV	80	256	16	-	3.3	N	SRAM, NOR	N	N	N	Y	3	1	1	MTU2, MTU2S, CMT	Y	12-bit (16)	-	73	8 DMA Channels, DTC, HW PWM Shutdown, On-chip Debug	-40 to +85	100QFP, 14x14x0.5		
		DF71374AN80FPV																					-20 to +85	80QFP, 14x14x0.65		
		DF71364AD80FPV																					-40 to +85			
		DF71364AN80FPV																					-20 to +85			
	SH7147	DF71474AK64FPV	64	256	12	-	3.3	N	SRAM, NOR	N	N	N	1	3	1	-	MTU2, CM	Y	12-bit (16)	-	73	DTC, HW PWM Shutdown, On-chip Debug & Trace	-40 to +125	100QFP, 14x14x0.5		
		DF71424AK64FPV		384	16																					
		DF71475AK64FPV																							2	
		DF71426AK64FPV																								1
DF71476AK64FPV		512																							1	
SH7080	DF70834AD80BGV	80	256	16	-	3.3	N	SRAM, SDRAM, NOR	N	N	N	N	4	1	1	MTU2, MTU2S, CMT	Y	10-bit (10)	-	73	4 DMA Channels, DTC, HW PWM Shutdown, On-chip Debug & Trace	-40 to +85	112QFP, 10x10x0.8			
	DF70845AD80FPV		512	32																			84	112QFP, 20x20x0.65		
	DF70865AD80FPV		512	32																			134	176QFP, 24x24x0.5		
SH/Tiny	DF71240AD50FPV	50	16	4	-	4.5-5.5	N	-	N	N	N	N	3	-	-	MTU2, CMT	Y	10-bit (8)	-	31	On-chip Debug	-40 to +85	48QFP, 10x10x0.6			
	DF71240AD50NPV																					31	-40 to +85	52QFN, 7x7x0.4		
	DF71242N50FPV																					31	-20 to +85	48QFP, 10x10x0.65		
	DF71242D50FPV																					31	-40 to +85	48QFP, 10x10x0.65		
	DF71252N50FPV		8	45																		-20 to +85	64QFP, 10x10x0.5			
	DF71243N50FPV			31																		-20 to +85	48QFP, 10x10x0.65			
	DF71243D50FPV			31																		-40 to +85	48QFP, 10x10x0.65			
	DF71253D50FPV			45																		-40 to +85	64QFP, 10x10x0.5			
MPU	SH7262	R5S72620P144FP#UZ	144	-	1088	8KB Inst	1.2, 3.3	Y	SRAM, SDRAM, NAND, NOR	N	HS	HS	N	8	2	3	MTU2, CMT, RTC	Y	10-bit (4)	-	89	LCD Controller, Video In, Decompression Unit, SSI, CDROM DEC, SRC, IEBUS, SDIO, SPDIF, 16 DMA Channels, JTAG Boundary Scan, On-chip Debug	-40 to +85	176QFP, 24x24x0.5		
		R5S72621P144FP#UZ																							740	8KB Data
		R5S72624P144FP#UZ																								
		R5S72625P144FP#UZ																								
	SH7264	R5S72640P144FP#UZ	144	-	1088	8KB Inst	1.2, 3.3	Y	SRAM, SDRAM, NAND, NOR	N	HS	HS	N	8	2	3	MTU2, CMT, RTC	Y	10-bit (4)	-	89	LCD Controller, Video In, Decompression Unit, SSI, CDROM DEC, SRC, IEBUS, SDIO, SPDIF, 16 DMA Channels, JTAG Boundary Scan, On-chip Debug	-40 to +85	208QFP, 28x28x0.5		
		R5S72641P144FP#UZ																							740	8KB Data
		R5S72644P144FP#UZ																								
		R5S72645P144FP#UZ																								
	SH7670	R5S76700B200BG	200	-	32	8KB Inst	1.2, 3.3	Y	SRAM, SDRAM, NOR, PCMCIA	Y	HS	HS	N	3	-	1	CMT	Y	-	-	86	STIF, I2S, HIF, 8 DMA Channels, JTAG Boundary Scan, On-chip Debug	-20 to +70	256BGA, 17x17x0.8		
		R5S76700D133BG																					133		-40 to +85	
		R5S76710B200BG																					200		-20 to +70	
		R5S76710D133BG																					133		-40 to +85	

Note: This table lists only select devices. For the complete list, please contact Renesas Technology America, Inc.

Acronyms	CMT: Compare Match Timer	RTC: Real Time Clock	SRC: Sampling Rate Converter
	HIF: Host Interface	SDIO: SD Memory I/O	SSI: Serial Sound Interface
	INTC: Interrupt Controller	SIOF: Serial I/O with FIFO	STIF: Serial Stream Interface
	MTU2: Multifunction Timer Unit	SPDIF: Sony/Philips Digital Interface	

© 2009 Renesas Technology America, Inc. Renesas Technology America, Inc. is a wholly owned subsidiary of Renesas Technology Corp. SuperH is a trademark of Renesas Technology Corp. All other trademarks are the property of their respective owners. The information supplied by Renesas Technology America, Inc. is believed to be accurate and reliable, but in no event shall Renesas Technology America, Inc. be liable for any damages whatsoever arising out of the use or inability to use the information or any errors that may appear in this publication. The information is provided as is without any warranties of any kind, either express or implied. Renesas Technology America, Inc. reserves the right, without notice, to make changes to the information or to the design and specifications of its hardware and/or software products. Products subject to availability.

Renesas Technology America, Inc.
 450 Holger Way, San Jose, CA 95134
 Tel: 408-382-7500 Fax: 408-382-7501
www.renesas.com