



Gas Discharge Tubes

TE Circuit Protection's GDTs (Gas Discharge Tubes) are placed in front of, and in parallel with, sensitive telecom equipment such as power lines, communication lines, signal lines and data transmission lines to help protect them from damage caused by transient surge voltages that may result from lightning strikes and equipment switching operations. These devices do not influence the signal in normal operation. However, in the event of an overvoltage surge, such as a lightning strike, the GDT switches to a low impedance state and diverts the energy away from the sensitive equipment.

Our GDTs offer a high level of surge protection, a broad voltage range, low capacitance, and many form factors including new surface mount devices, which makes them suitable for applications such as MDF (Main Distribution Frame) modules, high data-rate telecom applications (e.g. ADSL, VDSL), and surge protection on power lines. Their low capacitance also results in less signal distortion. When used in a coordinated circuit protection solution with PolySwitch devices, they can help equipment manufacturers meet stringent safety regulatory standards.



Benefits

- Helps provide overvoltage fault protection against damage caused by high energy surges
- Suitable for use in sensitive equipment due to impulse sparkover response
- Suitable for high-frequency applications
- Highly reliable performance
- New surface-mount devices for automated manufacturing

Features

- RoHS compliant
- Halogen free (refers to: Br \leq 900ppm, Cl \leq 900ppm, Br+Cl \leq 1500ppm)
- Wide range of voltages (75V-4000V)
- Wide range of form factors (3mm, 5mm, 6mm, 7mm, 8mm diameter devices)
- Low capacitance and insertion loss
- Crowbar device with low arc voltage
- High accuracy spark-over voltages for high precision designs
- Devices tested per ITU K.12 recommendations
- Various lead configurations and surface-mount options
- Optional fail-short mechanism
- Non radioactive materials
- Devices certified to UL497B and UL1449

Applications

- Telecommunications
 - MDF modules, xDSL equipment, RF systems, antenna, base stations
- Industrial and Consumer Electronics
 - Power supplies, surge protectors, alarm systems, irrigation systems

Figure G1-G2 Typical Circuits for Gas Discharge Tubes

Figure G1

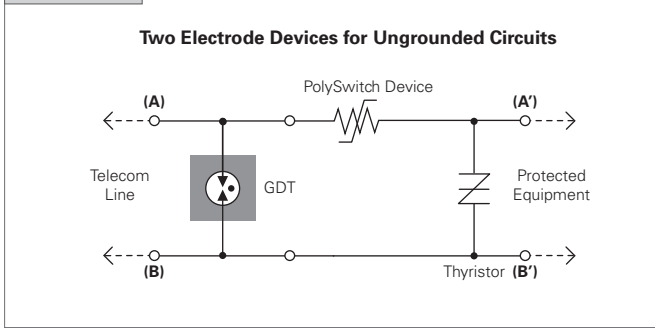

Figure G2

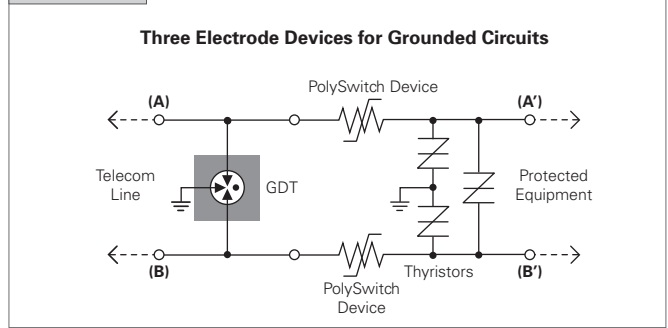

Table G1 Device Voltage Ratings, Surge Rating, Capacitance, Insulation Resistance, and Agency Approval for Two Electrode Gas Discharge Tubes

Part Number	DC Sparkover Voltage	Impulse Sparkover Voltage	Impulse Discharge Current		Impulse Withstanding Voltage	Capacitance	Insulation Resistance	UL Rating
	@ 100V/s ± 20% Tolerance	@ 1kV/μs	8x20μs 10 hits (5 hits each polarity)	8x20μs 300 hits (150 hits each polarity)	10/700μs 10 hits (5 times each polarity)	@1MHz	@100V _{DC} [†]	UL497B #E179610
GTCS23-XXXM-R01-2	75*	600	1kA	100A	4kV	<0.5pF	1,000 (MΩ)	All Devices
	90	600						
	140	600						
	150	600						
GTCC23-XXXM-R01-2	200	700	1kA	100A	6kV [‡]	<0.5pF	1,000 (MΩ)	All Devices
	230	700						
	300	900						
	350	1000						
	400	1000						

* DCSO 60~105
[†] Devices <=150V measured @ 50V_{DC}
[‡] Effective output impedance: 40ohms

Part Number	DC Sparkover Voltage	Impulse Sparkover Voltage		DC Holdover Voltage	On-State Voltage	Impulse Discharge Current	Impulse Life	AC Discharge Current (1sec duration; 10 hits)	Capacitance	Insulation Resistance	UL Rating
	@ 100V/s ± 20% Tolerance	@ 100V/μs	@ 1kV/μs	Per ITU K.12	Nominal (@1A) (V)	8x20μs 10 hits	10x1000μs 300 hits	@ 50 Hz	@ 1MHz	@ 100V _{DC}	UL497B #E179610
GTCX25-XXXM-R02	75	450	550	<52	20	2.5kA	100A	2.5Arms	<1pF	10,000 (MΩ)	All Devices
	90	450	550	<52	20						
	140	500	600	<80	20						
GTCX26-XXXM-R05	150	500	600	<80	20	5kA	100A	5Arms	<1pF	10,000 (MΩ)	All Devices
	200	600	700	<135	20						
	230	600	700	<135	20						
GTCX28-XXXM-R05	250	600	700	<135	20	5kA	100A	5Arms	<1pF	10,000 (MΩ)	All Devices
	260	700	800	<135	20						
	300	800	900	<150	20						
GTCX28-XXXM-R10	350	900	1000	<150	20	10kA	100A	10Arms	<1pF ^{††}	10,000 (MΩ)	All Devices
	400	900	1000	<150	20						
	420	900	1000	<150	20						
GTCX28-XXXM-R20**	470	1050	1150	<150	20	20kA	100A	20Arms	<1.5pF	10,000 (MΩ)	All Devices
	500	1100	1200	<150	20						
	550	1300	1400	<150	20						
	600	1300	1400	<150	20						

** GTCX28-XXXM-R20 parts only up to 350V
^{††} <1.2pF for 75V and 90V devices.

Table G2 Device Voltage Ratings, Surge Rating, Capacitance, Insulation Resistance, and Agency Approval for Two Electrode High Voltage Gas Discharge Tubes

Part Number	DC Sparkover Voltage	Impulse Sparkover Voltage	Impulse Life	AC Discharge Current, 50 Hz		Impulse Discharge Current 8/20µs		Capacitance	UL Rating
	@100V/s ± 20% Tolerance	@ 100 V/µs		10/1000µs 100A	Multiple hits (1s duration: 10 hits)	Single hit, 9 cycles	10 hits (5 hits each polarity)		
GTCA28-801M-R05	800	1400	300 times	5A	N/A	5kA	N/A	<1pF	✓
GTCA28-102M-R03	1000	1700	N/A	1A	5A	3kA	10kA	<1pF	✓
GTCA28-122M-R03	1200	1900	N/A	1A	5A	3kA	10kA	<1pF	✓
GTCA28-152L-R03	1500 (± 15%)	2200	N/A	1A	5A	3kA	10kA	<1pF	✓
GTCA28-212M-R03	2100	2700	N/A	1A	5A	3kA	10kA	<1pF	✓
GTCA28-242M-R03	2400	3300	N/A	1A	5A	3kA	10kA	<1pF	✓
GTCA28-252M-R03	2500	3500	N/A	1A	5A	3kA	10kA	<1pF	✓
GTCA28-272L-R03	2700 (± 15%)*	3700	300 times†	N/A	N/A	3kA	10kA	<1pF	✓
GTCA28-302M-R03	3000	4000	N/A	1A	5A	3kA	10kA	<1pF	✓
GTCA28-312L-R03	3100 (± 15%)*	3700‡	300 times†	N/A	N/A	3kA	10kA	<1pF	✓
GTCA28-362M-R03	3600	4600	N/A	1A	5A	3kA	10kA	<1pF	✓
GTCA28-402M-R03	4000	5000	N/A	1A	5A	3kA	10kA	<1pF	✓

Note: Insulation resistance: ≥10,000MΩ (all parts measured @ 1000V_{DC}, except 800V/1000V/1200V @250V_{DC}; 1500V/2100V @ 500V_{DC})

* DC Sparkover Voltage measured at 5kV/s

† Measured with 8/20µs, 100A impulse

‡ Measured at 1000V/µs

Table G3 Device Voltage Ratings, Surge Rating, Capacitance, Insulation Resistance, and Agency Approval for Three Electrode Gas Discharge Tubes

Part Number	DC Sparkover Voltage (A-E) (B-E)	Impulse Sparkover Voltage (A-E) (B-E)		DC Holdover Voltage	On-State Voltage	Impulse Discharge Current (A+B-E)	Impulse Life (A+B-E)	AC Discharge Current (1sec duration; 10 hits) (A+B-E)	Capacitance	Insulation Resistance	UL Rating
	@ 100V/s ± 20% Tolerance	@ 100V/µs	@ 1kV/µs	Per ITU K.12	Nominal (@1A) (V)	8x20µs 10 hits	10x1000µs 300 hits	@ 50 Hz			
GTCX35-XXXM-R05	75	450	550	<52	20	5kA	100A	5Arms	<1pF	10,000 (MΩ)	All Devices
	90	450	550	<52	20						
	140	500	600	<80	20						
GTCX36-XXXM-R05	150	500	600	<80	20	5kA	200A	5Arms	<1pF	10,000 (MΩ)	All Devices
	200	600	700	<135	20						
	230	600	700	<135	20						
GTCX36-XXXM-R10	250	600	700	<135	20	10kA	200A	10Arms	<1pF	10,000 (MΩ)	All Devices
	260	700	800	<135	20						
	300	800	900	<150	20						
GTCX37-XXXM-R10	350	900	1000	<150	20	10kA	200A	10Arms	<1pF	10,000 (MΩ)	All Devices
	400	900	1000	<150	20						
	420	900	1000	<150	20						
GTCX38-XXXM-R10	470	1050	1150	<150	20	10kA	200A	10Arms	<1pF	10,000 (MΩ)	All Devices
	500	1100	1200	<150	20						
	550	1300	1400	<150	20						
	600	1300	1400	<150	20						

* Insulation resistance measured at 50V for devices less than 150V.
 Insulation resistance measured at 250V for devices more than 500V.

Figure G3-G11 Dimensions for Gas Discharge Tubes

Figure G3 Two Electrode 3mm Product Dimensions

Surface-mount (GTCS23-XXXM-R01)

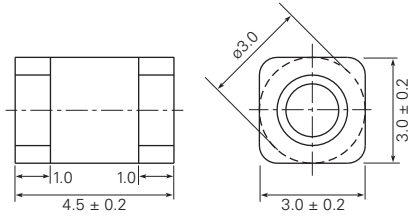

Pad Layout - Surface-mount Devices (GTCS23-XXXM-R01)

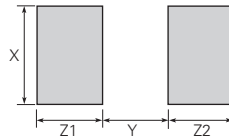

	X	Y	Z1	Z2
	Nom.	Nom.	Nom.	Nom.
mm	3.0	2.0	2.0	2.0
in*	(0.118)	(0.079)	(0.079)	(0.079)

* The dimensions in inches are rounded approximations.

Chip GDT (GTCC23-XXXM-R01)

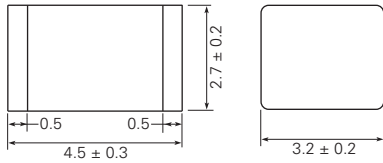

Pad Layout - Chip GDT Devices (GTCC23-XXXM-R01)

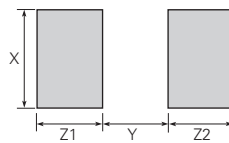

	X	Y	Z1	Z2
	Nom.	Nom.	Nom.	Nom.
mm	3.5	2.7	2.0	2.0
in*	(0.138)	(0.106)	(0.079)	(0.079)

* The dimensions in inches are rounded approximations.

Figure G4 Two Electrode 5mm Product Dimensions

Axial Leads (GTCA25-XXXM-R02)

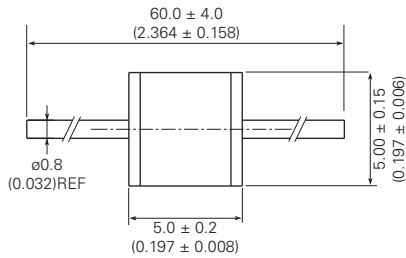

No Leads (GTCN25-XXXM-R02)[†]

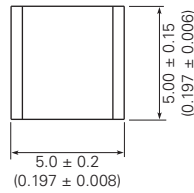

Surface-mount (GTCS25-XXXM-R02)

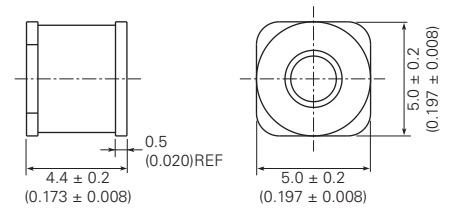

Pad Layout - Surface-mount Devices (GTCS25-XXXM-R02)

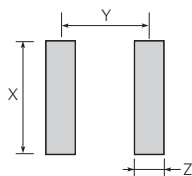

	X	Y	Z
	Nom.	Nom.	Nom.
mm	6.0	3.9	1.3
in*	(0.197)	(0.154)	(0.051)

* The dimensions in inches are rounded approximations.

[†] Parts with no leads are not solderable and are meant for insertion into magazine clips.

Figure G3-G11 Dimensions for Gas Discharge Tubes

Cont'd

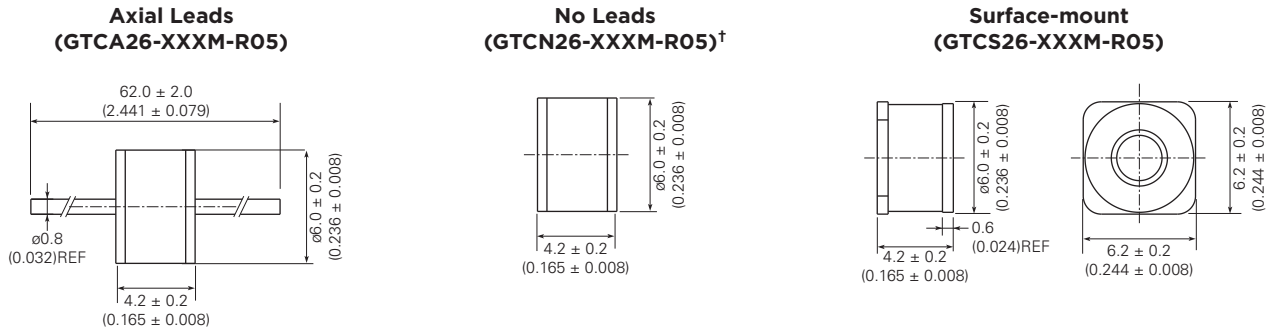
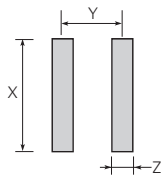
Figure G5 Two Electrode 6mm Product Dimensions

Pad Layout - Surface-mount Devices
(GTCS26-XXXM-R05)

	X	Y	Z
	Nom.	Nom.	Nom.
mm	7.0	3.7	1.3
in*	(0.276)	(0.146)	(0.051)

* The dimensions in inches are rounded approximations.

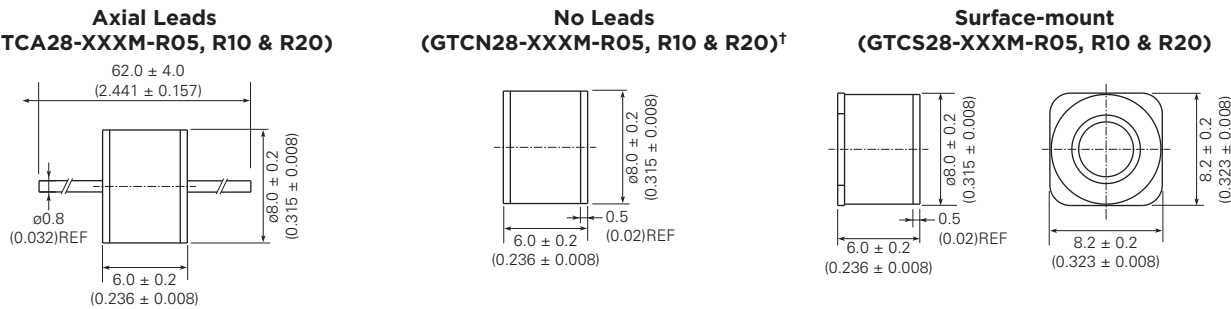
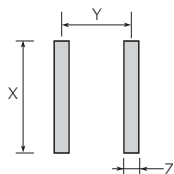
[†] Parts with no leads are not solderable and are meant for insertion into magazine clips.

Figure G6 Two Electrode 8mm Product Dimensions

Pad Layout - Surface-mount Devices
(GTCS28-XXXM-R05, R10 & R20)

	X	Y	Z
	Nom.	Nom.	Nom.
mm	9.0	5.6	1.2
in*	(0.354)	(0.22)	(0.047)

* The dimensions in inches are rounded approximations.

[†] Parts with no leads are not solderable and are meant for insertion into magazine clips.

Figure G7 Two Electrode 8mm High Voltage Product Dimensions

Figure G8 Three Electrode 5mm Product Dimensions

Pad Layout - Surface-mount Devices (GTCS35-XXXM-R05)

	X	Y1	Y2	Z1	Z2
	Nom.	Nom.	Nom.	Nom.	Nom.
mm	6.0	3.6	3.6	2.5	1.3
in*	(0.236)	(0.142)	(0.142)	(0.098)	(0.051)

* The dimensions in inches are rounded approximations.

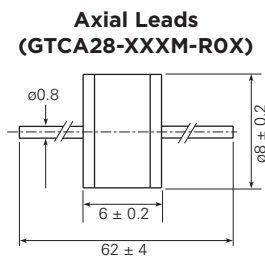
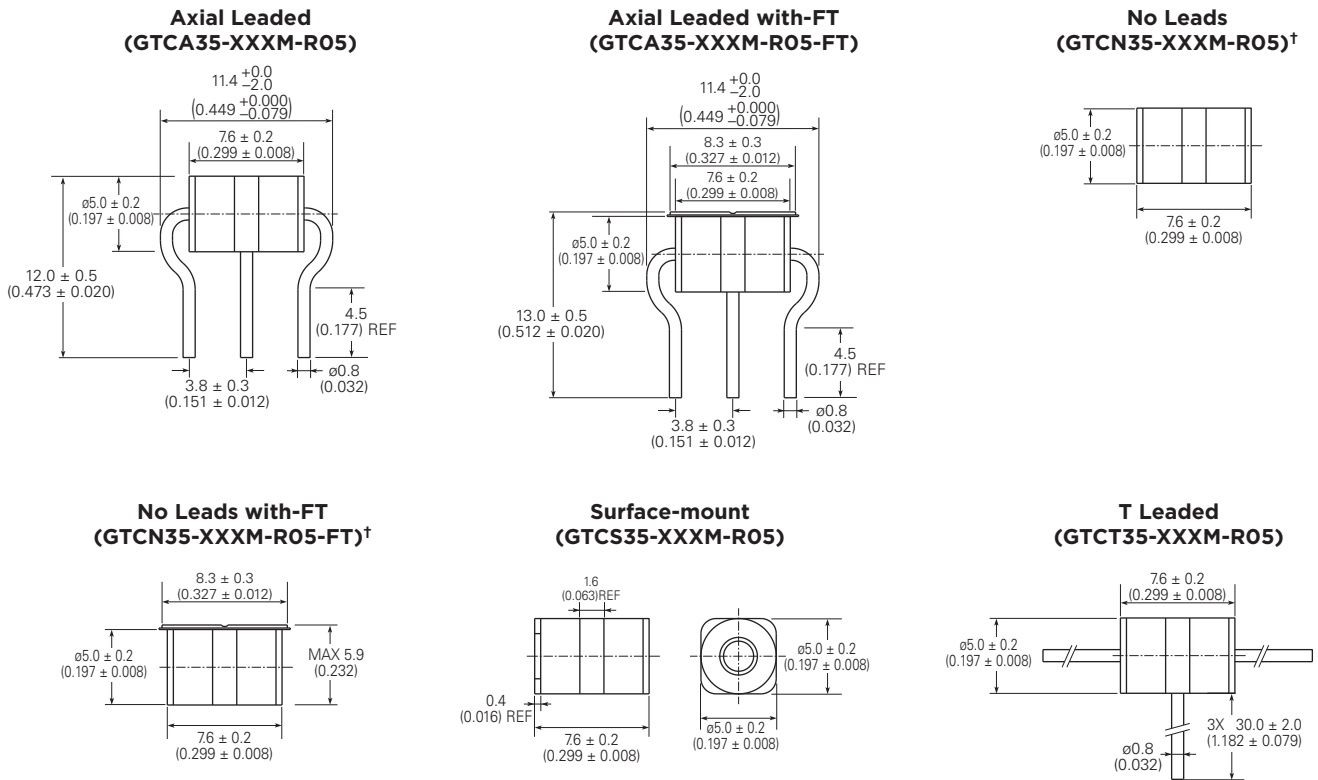
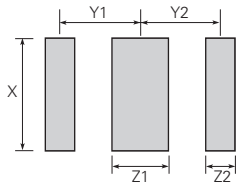
† Parts with no leads are not solderable and are meant for insertion into magazine clips.

Figure G3-G11 Dimensions for Gas Discharge Tubes

Cont'd

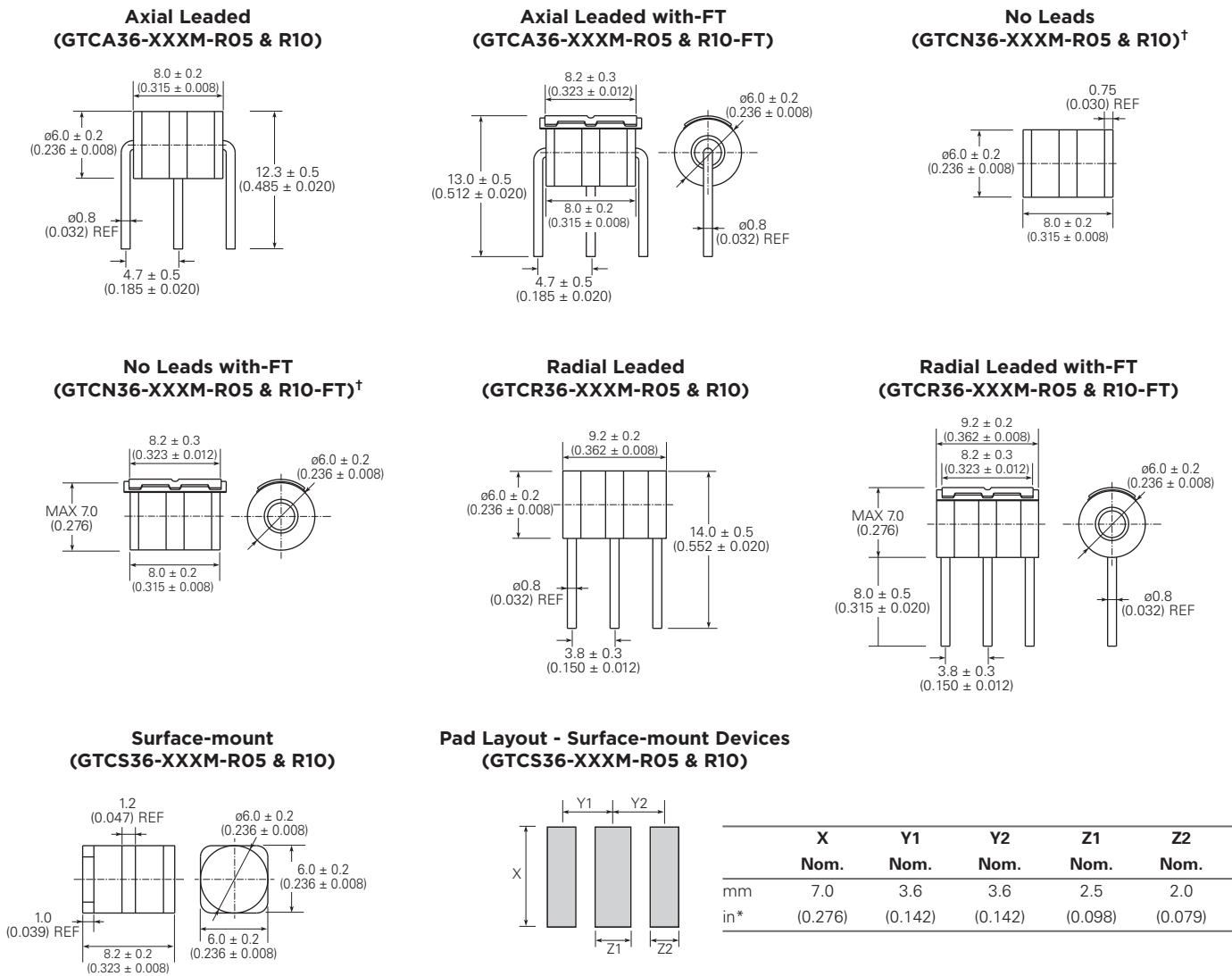
Figure G9 Three Electrode 6mm Product Dimensions

* The dimensions in inches are rounded approximations.

† Parts with no leads are not solderable and are meant for insertion into magazine clips.

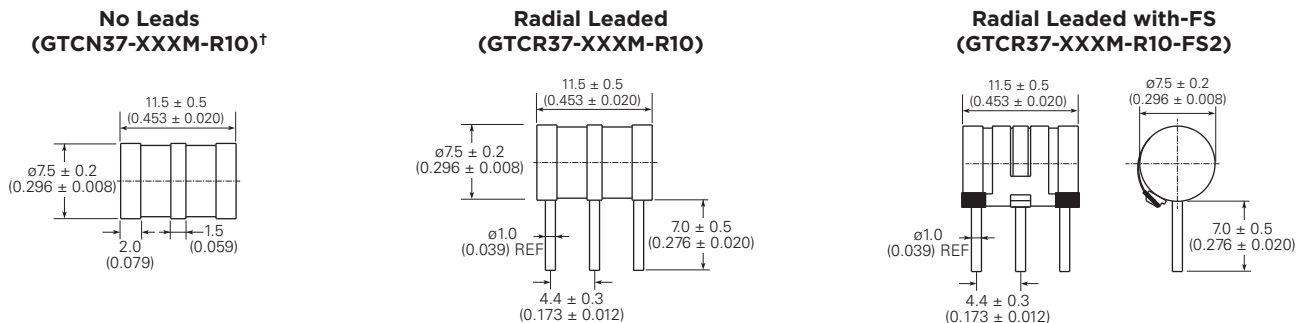
Figure G10 Three Electrode 7mm Product Dimensions

† Parts with no leads are not solderable and are meant for insertion into magazine clips.

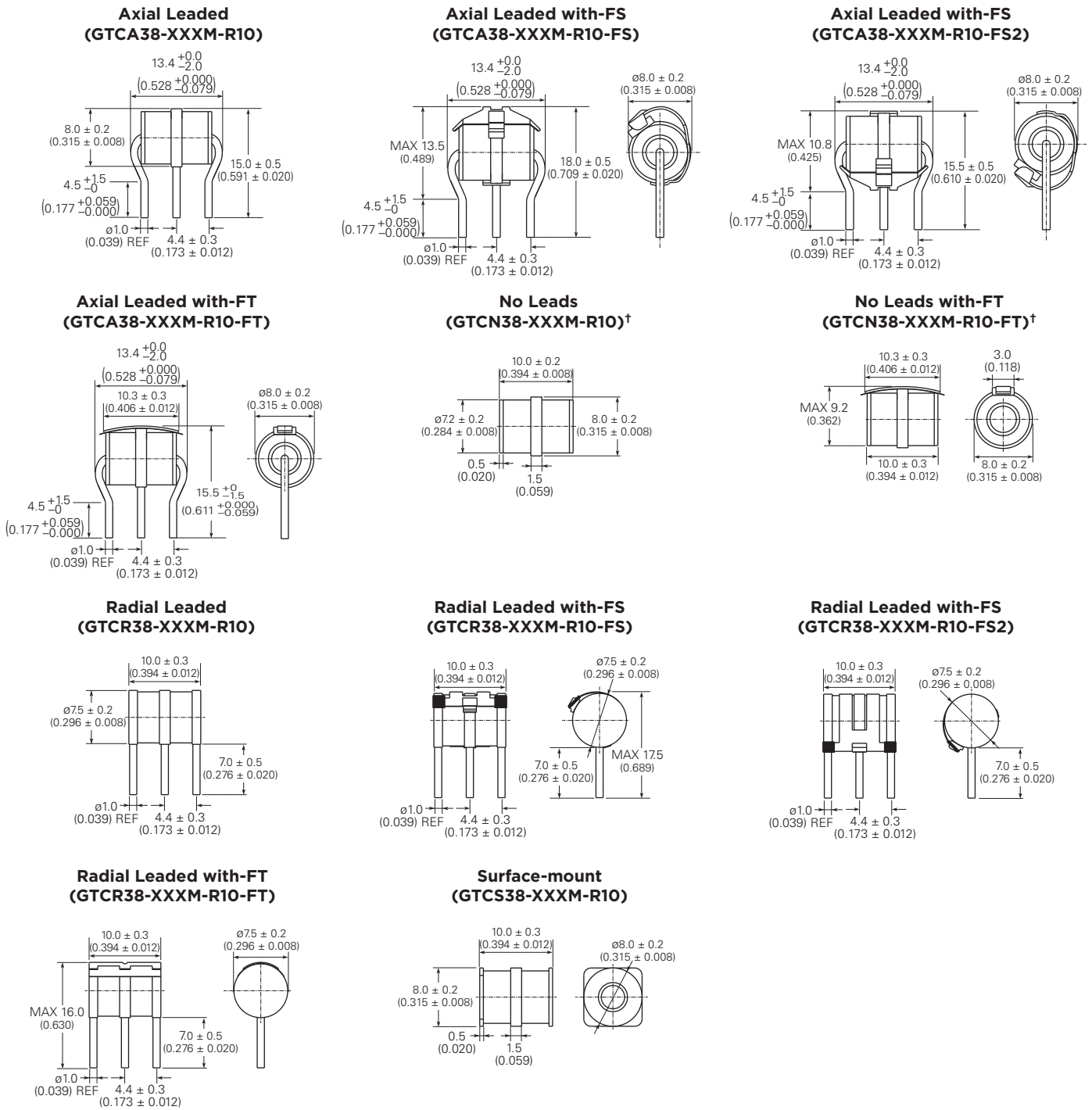
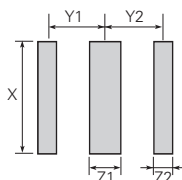
Figure G11 Three Electrode 8mm Product Dimensions

Pad Layout - Surface-mount Devices (GTCS38-XXXM-R10)

	X	Y1	Y2	Z1	Z2
	Nom.	Nom.	Nom.	Nom.	Nom.
mm	9.0	4.65	4.65	2.5	1.5
in*	(0.354)	(0.183)	(0.183)	(0.098)	(0.059)

* The dimensions in inches are rounded approximations.

† Parts with no leads are not solderable and are meant for insertion into magazine clips.

Fail-Short Mechanism for Gas Discharge Tubes

Fail-Short Mechanism (FS)

The FS fail-short mechanism is a short circuit spring mounted onto a solder pellet located at the center electrode of the gas tube. Under normal operating conditions, the pellet is positioned to make the spring float above the outer electrodes, as shown in Figure G11.

When a prolonged discharge event causes the gas tube temperature to reach the melting point of the solder, the pellet softens allowing the short circuit spring to contact with both outer electrodes. This process results in a permanent short-circuit between all three electrodes creating a low resistance path that conducts the fault current to ground without generating a significant amount of heat.

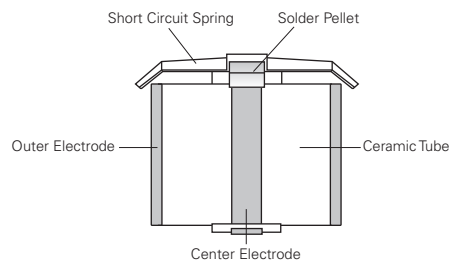

Figure G11

Fail-Short Mechanism (FT)

The FT fail-short mechanism is a short circuit spring with a piece of plastic foil spot welded onto the center electrode. Under normal operating conditions, the plastic foil makes the spring insulated from the two outer electrodes.

When a prolonged discharge event causes the gas tube temperature to reach the melting point of the plastic foil, the plastic foil melts allowing the short circuit spring to contact both outer electrodes. This process results in a permanent short-circuit between all three electrodes creating a low resistance path that conducts the fault current to ground without generating a significant amount of heat.

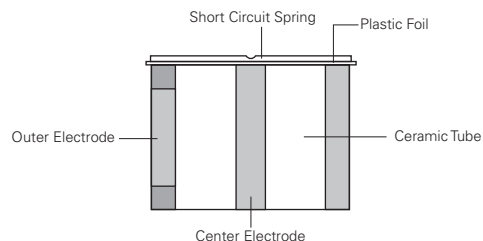

Figure G12

Operation and Storage Temperatures for Gas Discharge Tubes

Operation Temperature Range

Models without Fail-Short Mechanism : -40°C/+90°C
 Models with Fail-Short Mechanism : -20°C/+65°C

Storage Temperature Range

Models without Fail-Short Mechanism : -40°C/+90°C
 Models with Fail-Short Mechanism : -20°C/+65°C

Packaging Information for Gas Discharge Tubes

Part Description	Parts in Bulk		Parts in Tape and Reel	
	Min Order Quantity	Box Quantity	Tape & Reel Min Order Quantity	Box Quantity
3mm 2Pole Surface-mount	-	-	2000	16000
5mm 2Pole No leads	5000	20000	-	-
5mm 2Pole, Leads	1000	5000	-	-
5mm 2Pole Surface-mount	5000	20000	1500	12000
6mm 2Pole No leads	2000	10000	-	-
6mm 2Pole, Leads	1000	5000	-	-
6mm 2Pole Surface-mount	2000	10000	750	6000
8mm 2pole No leads	2000	10000	-	-
8mm 2Pole, Leads	1000	5000	-	-
8mm 2Pole Surface-mount	2000	10000	500	4000
5mm 3Pole No leads	2500	10000	-	-
5mm 3Pole, Leads	1000	5000	-	-
5mm 3Pole Surface-mount	2500	10000	1000	8000
6mm 3Pole No leads	2500	10000	-	-
6mm 3Pole, Leads	1000	5000	-	-
6mm 3Pole Surface-mount	2500	10000	750	4500
7mm 3Pole, Leads	1000	5000	-	-
8mm 3Pole No leads	1000	5000	-	-
8mm 3Pole, Leads	1000	5000	-	-
8mm 3Pole Surface-mount	1000	5000	500	2500

Installation for Gas Discharge Tubes

Care should be taken when installing Gas Discharge Tubes equipped with Fail-Short Mechanisms into arrester magazines, printed circuit boards, etc. Too much downward pressure may force the short circuit spring through the thin insulation tube creating a shorted condition.

Solder Reflow Recommendations for Surface-mount GDT Devices

Surface-mount GDTs can be soldered using standard Pb-free reflow profile.

Part Numbering System for Gas Discharge Tubes

Example Part Number for Gas Discharge Tubes

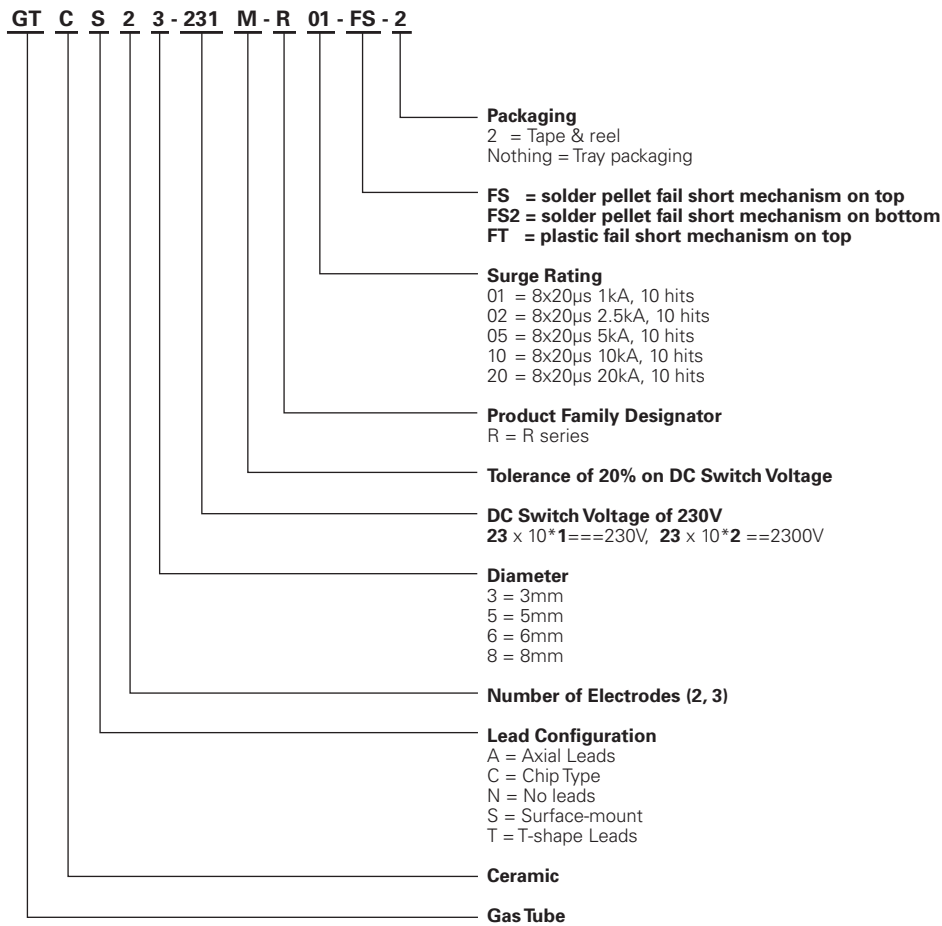

NOTE: GTCS23-XXXM-R01 and GTCC23-XXXM-R01 parts available only in surface-mount and tape and reel packaging

Part Numbering System for Gas Discharge Tubes

Cont'd

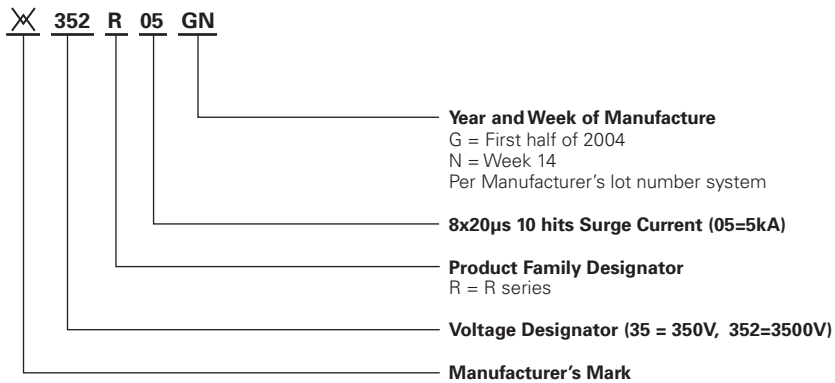
Marking Reference Guide - Example

NOTES: GTCS23-XXXM-R01 and GTCC23-XXXM-R01 parts will have no marking.
 Devices with no leads (GTCNxx-xxxx-xx) are not able to be soldered as their electrodes are Nickel plated.
 They should be installed by insertion into a magazine clip.

Warning :

- Users should independently evaluate the suitability of and test each product selected for their own application.
- Operation beyond the maximum ratings or improper use may result in device damage and possible electrical arcing and flame.
- The devices are intended for protection against damage caused by occasional overvoltage fault conditions and should not be used when repeated fault conditions or prolonged trip events are anticipated.
- Device performance can be impacted negatively if devices are handled in a manner inconsistent with recommended electronic, thermal, and mechanical procedures for electronic components.

