

Surface-mount Fuses Fundamentals

Overview

TE Circuit Protection offers the widest selection of surface-mount fuses available for addressing a broad range of overcurrent protection applications. Helping to prevent costly damage and promote a safe environment for electronic and electrical equipment, our single-use chip fuses provide performance stability to support applications with current ratings from .5A up to 20A.

TE Circuit Protection also offers the telecom FT600 fuse for telecommunications applications. This telecom fuse helps comply with North American overcurrent protection requirements, including Telcordia, GR-1089, TIA-968-A (formerly FCC Part 68), and UL60950 3rd edition.



Multi-layer Design for Chip Fuses

The multi-layer design has the benefit of exposing more fuse element surface area to the glass-ceramic absorption material. When the fuse elements open, there is more material for the vaporizing fuse metals to absorb into, resulting in a very efficient and effective quenching of the fuse arc.

Figure 1 compared the multi-layer design of our SFF fuses with standard glass coated designs. The glass coated designs rely on the coating on only one side of the fuse element to absorb the vaporizing fuse material when it opens. Therefore, there is much less absorption material available to absorb the fuse metals. The result can be prolonged arcing and possible coating breach.

Figure 2 shows how the absorption characteristics of the two designs differ. The multi-layer design indicates a clean separation with the fuse element evenly diffusing into the surrounding ceramic substrate. In the glass coated design, the element diffusion takes place in a small portion of the device and is only absorbed by the glass material directly above the area of failure.

Figure 1

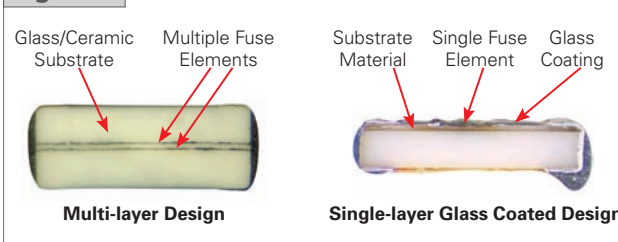
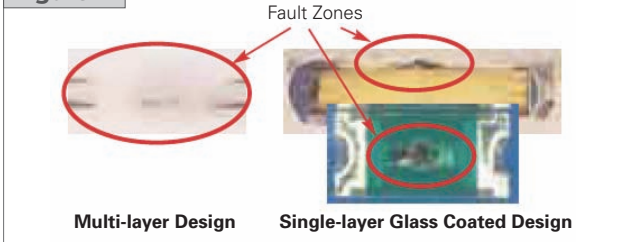


Figure 2



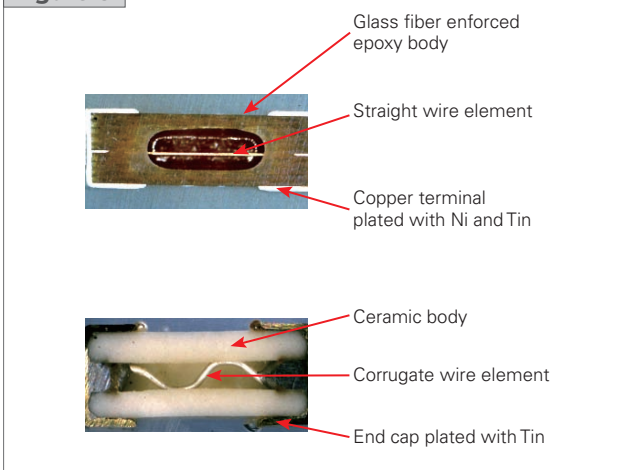
Wire-In-Air Design for 2410SFV Fuses

The 2410(6125) is a Wire-In-Air SMD Fuse which is very suitable for secondary level over current protection applications.

Figure 3 compared our straight wire element design 2410SFV fuses with normal corrugating wire design fuse. The straight wire element in air performs consistent fusing and cutting characteristics together with excellent inrush current withstanding capability.

Introduced PCB assembly technology into 2410SFV fuses design and manufacture, we achieved on lead free completely and no end cap falling off risk comparing with traditional ceramic body with end cap fuse.

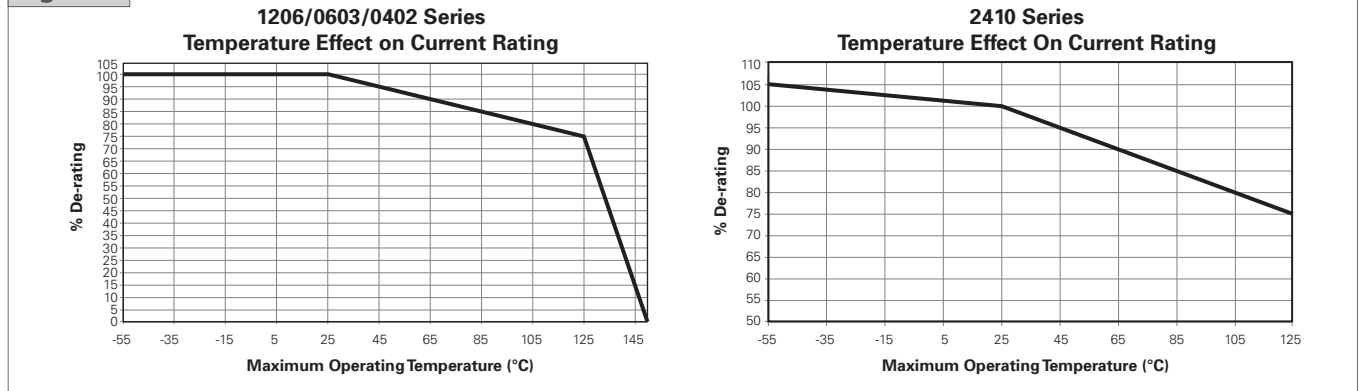
Figure 3



Temperature Derating

A fuse is a temperature sensitive device. Therefore, operating temperature will have an effect on fuse performance and lifetime. Operating temperature should be taken into consideration when selecting the fuse current rating. The Thermal Derating Curve for surface mount fuses is presented in Figure 4. Use it to determine the derating percentage based on operating temperature and apply it to the derated system current.

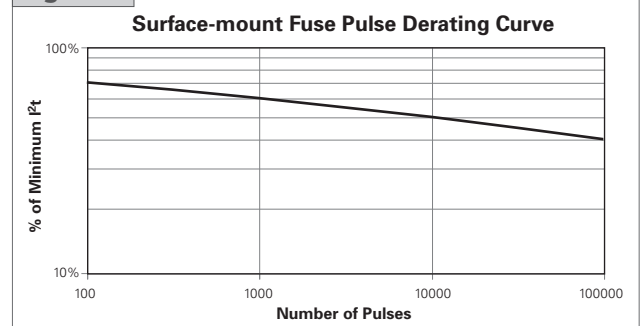
Figure 4



Pulse Cycle Derating

Once the I^2t value for the application waveform has been determined, it must be derated based on the number of cycles expected over the system lifetime. Since the stress induced by the current pulse is mechanical in nature, the number of times the stress is applied has significant bearing on how much derating must be applied to the fuse rating. Figure 5 presents the current pulse derating curve for our surface-mount chip fuses up to 100,000 cycles.

Figure 5



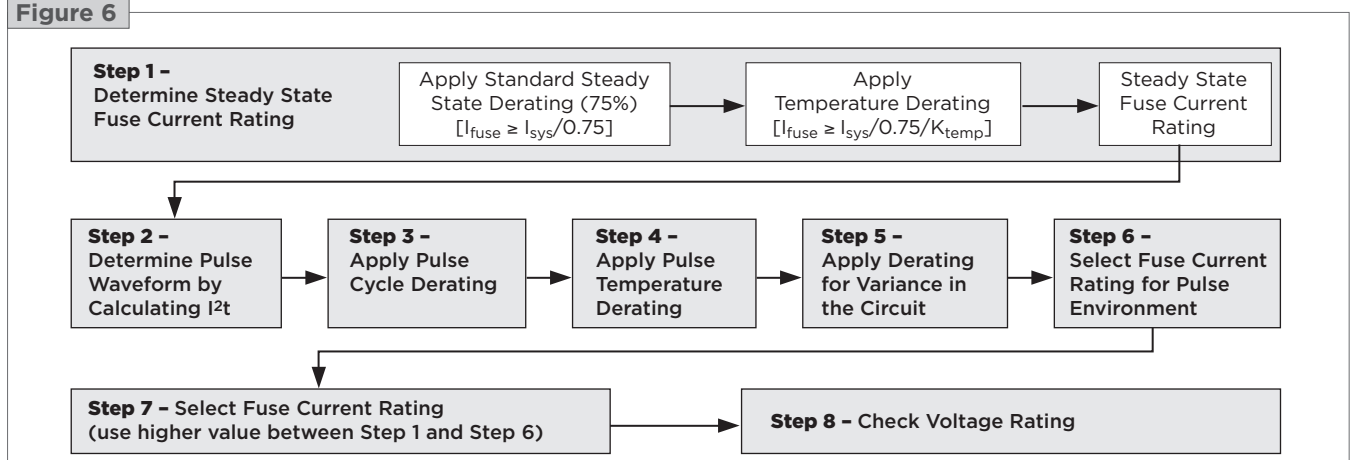
Selecting Surface-mount Fuses

Fuse selection seems straightforward, in that, you pick one which has a current rating just a bit higher than your worstcase system operating current. Unfortunately, it's not that simple. There are derating considerations for operating current and application temperature. Turn-on and other system operations (like processor speed changes or motor start up) cause current surges or spikes that also require consideration when selecting a fuse. So selecting the right fuse for your application is not as simple as knowing the nominal current drawn by the system.

Fuse Selection Flowchart

However, the basic considerations for fuse selection are shown in the flowchart presented in Figure 6. Following this flow chart will help you select a fuse best suited for your application conditions.

Figure 6





Surface-mount Fuses Pulse Tolerant Chip Fuses



Pulse Tolerant chip fuses has high inrush current withstand capability and provide overcurrent protection on DC power systems. Silver fusing element, monolithic and multilayer design provides strong arc suppression characteristics.

These RoHS-compliant surface-mount devices facilitate the development of more reliable, high performance consumer electronics such as laptops, multimedia devices, cell phones, and other portable electronics.



Benefits

- High inrush current withstanding capability
- Ceramic Monolithic structure
- Silver fusing element and silver termination with nickel and tin plating
- Excellent temperature stability
- Strong arc suppression characteristics

Features

- Lead free materials and RoHS compliant
- Halogen free
(refers to: Br≤900ppm, Cl≤900ppm, Br+Cl≤1500ppm)
- Monolithic, multilayer design
- High-temperature performance
- -55°C to +125°C operating temperature range

Applications

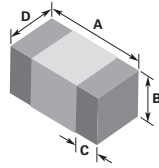
- | | | |
|-------------------|------------------------|----------------|
| • Laptops | • Printers | • Game systems |
| • Digital cameras | • DVD players | • LCD monitors |
| • Cell phones | • Portable electronics | • Scanners |

Table FP1 Clear Time Characteristics for Pulse Tolerant Chip Fuses

% of rated current	Clear time at 25°C	
100%	4 hours (min.)	
200%	1 seconds (min.)	60 seconds (max.)
1000%	0.0002 second (min.)	0.02 seconds (max.)

Table FP2 Typical Electrical Characteristics and Dimensions for Pulse Tolerant Chip Fuses
0603 (1608 mm) Pulse Tolerant Chip Fuses

Shape and Dimensions
mm (Inch)

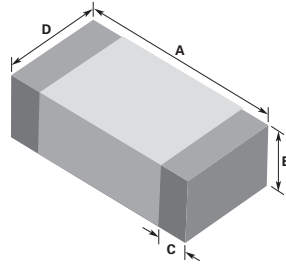


	A		B		C		D	
	Min	Max	Min	Max	Min	Max	Min	Max
mm	1.45	1.75	0.65	0.95	0.21	0.51	0.65	0.95
in	(0.057)	(0.069)	(0.026)	(0.037)	(0.008)	(0.020)	(0.026)	(0.037)

Part Number	Typical Electrical Characteristics			Max. Interrupt Ratings	
	Rated Current (A)	Nominal Cold DCR (Ω)*	Nominal I ² t (A ² sec) [†]	Voltage (V _{DC})	Current (A)
0603SFP100F/32-2	1.0	0.210	0.080	32	50
0603SFP150F/32-2	1.5	0.101	0.11	32	50
0603SFP200F/32-2	2.0	0.057	0.24	32	50
0603SFP250F/32-2	2.5	0.042	0.56	32	50
0603SFP300F/32-2	3.0	0.030	0.72	32	50
0603SFP350F/32-2	3.5	0.022	1.10	32	50
0603SFP400F/32-2	4.0	0.018	2.08	32	50
0603SFP450F/32-2	4.5	0.014	2.63	32	50
0603SFP500F/32-2	5.0	0.013	3.25	32	50

1206 (3216 mm) Pulse Tolerant Chip Fuses

Shape and Dimensions
mm (Inch)



	A		B		C		D	
	Min	Max	Min	Max	Min	Max	Min	Max
mm	3.00	3.40	0.77	1.17	0.26	0.76	1.40	1.80
in	(0.118)	(0.134)	(0.030)	(0.046)	(0.010)	(0.030)	(0.055)	(0.071)

Part Number	Typical Electrical Characteristics			Max. Interrupt Ratings	
	Rated Current (A)	Nominal Cold DCR (Ω)*	Nominal I ² t (A ² sec) [†]	Voltage (V _{DC})	Current (A)
1206SFP100F/63-2	1.0	0.340	0.11	63	50
1206SFP150F/63-2	1.5	0.150	0.33	63	50
1206SFP200F/63-2	2.0	0.090	0.80	63	50
1206SFP250F/32-2	2.5	0.070	1.19	32	50
1206SFP300F/32-2	3.0	0.035	1.35	32	50
1206SFP350F/32-2	3.5	0.029	1.84	32	50
1206SFP400F/32-2	4.0	0.023	2.74	32	50
1206SFP450F/32-2	4.5	0.021	3.20	32	50
1206SFP500F/32-2	5.0	0.017	5.50	32	50

* Measured at ≤10% of rated current and 25°C ambient temperature.
[†] Melting I²t at 0.001 sec clear time.

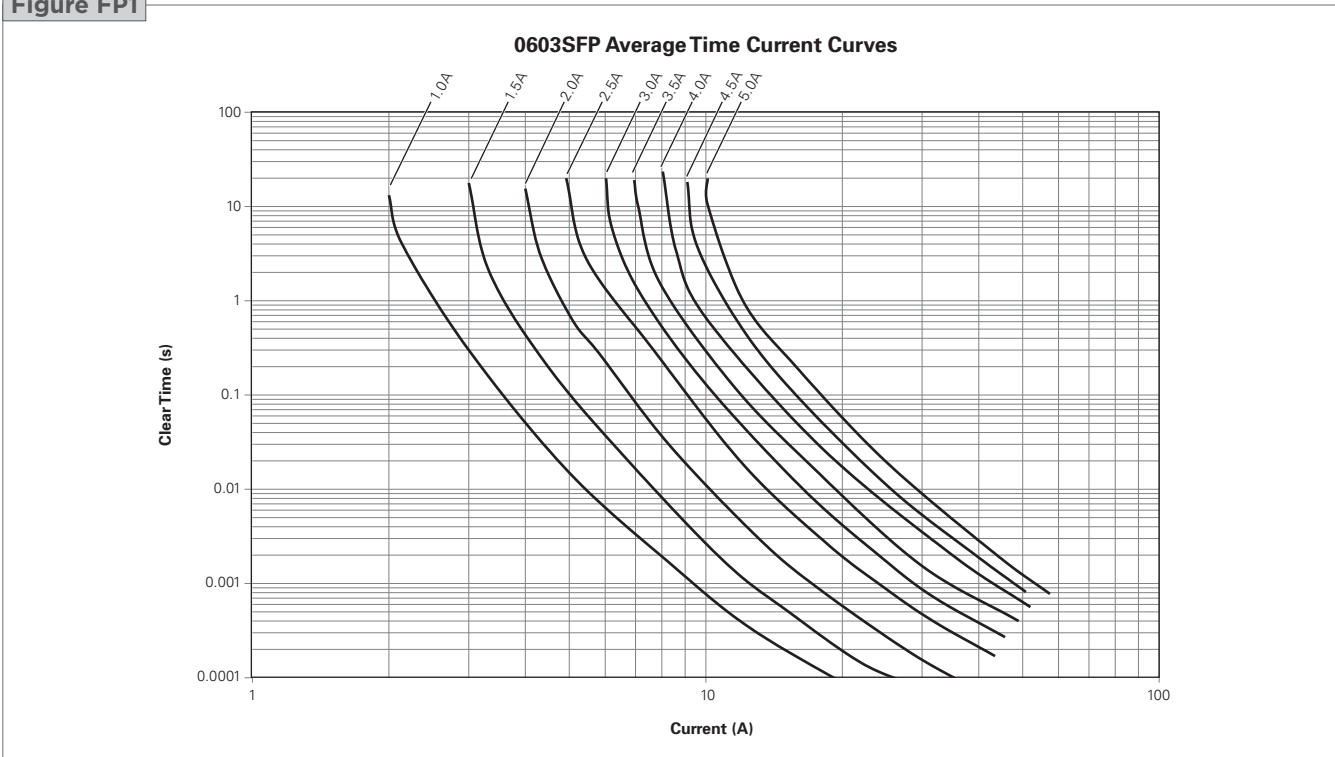
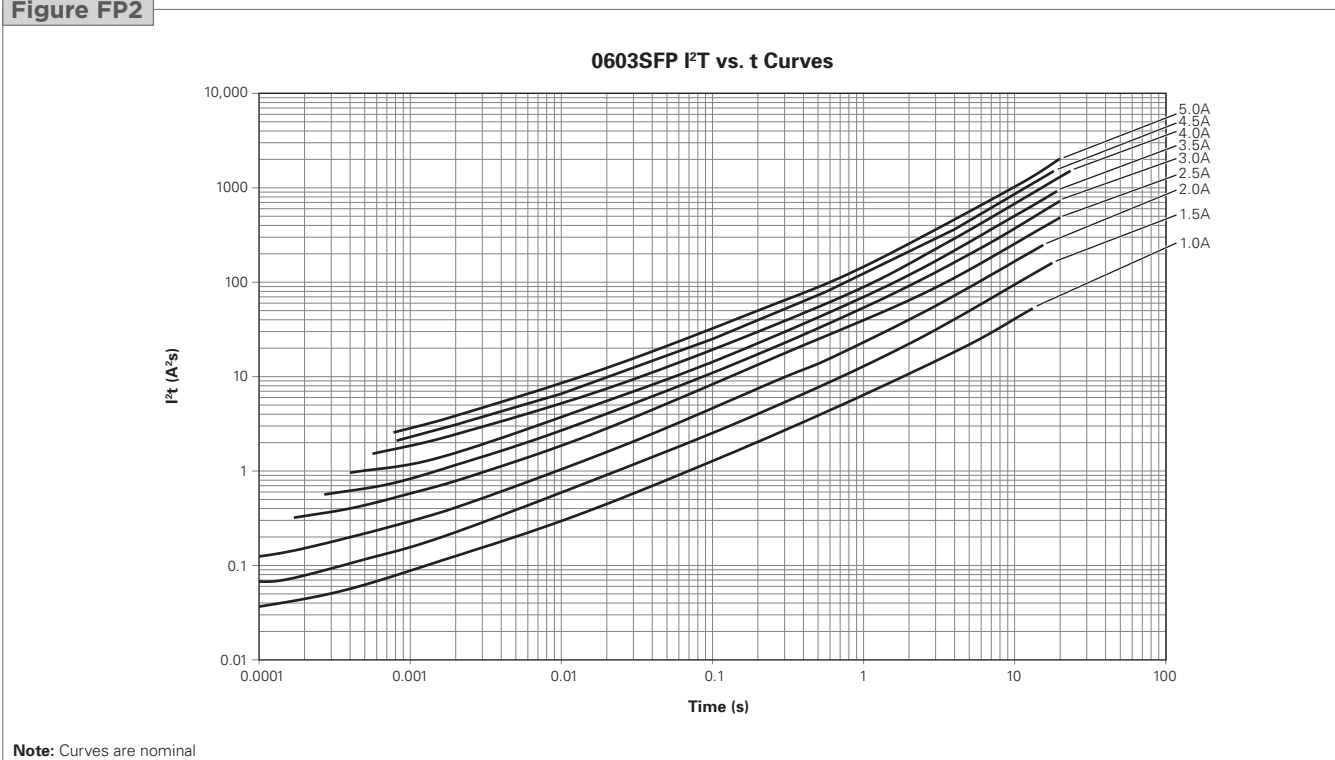
Figure FP1-FP4 Family Performance Curves for Pulse Tolerant Chip Fuses
Figure FP1

Figure FP2


Figure FP3

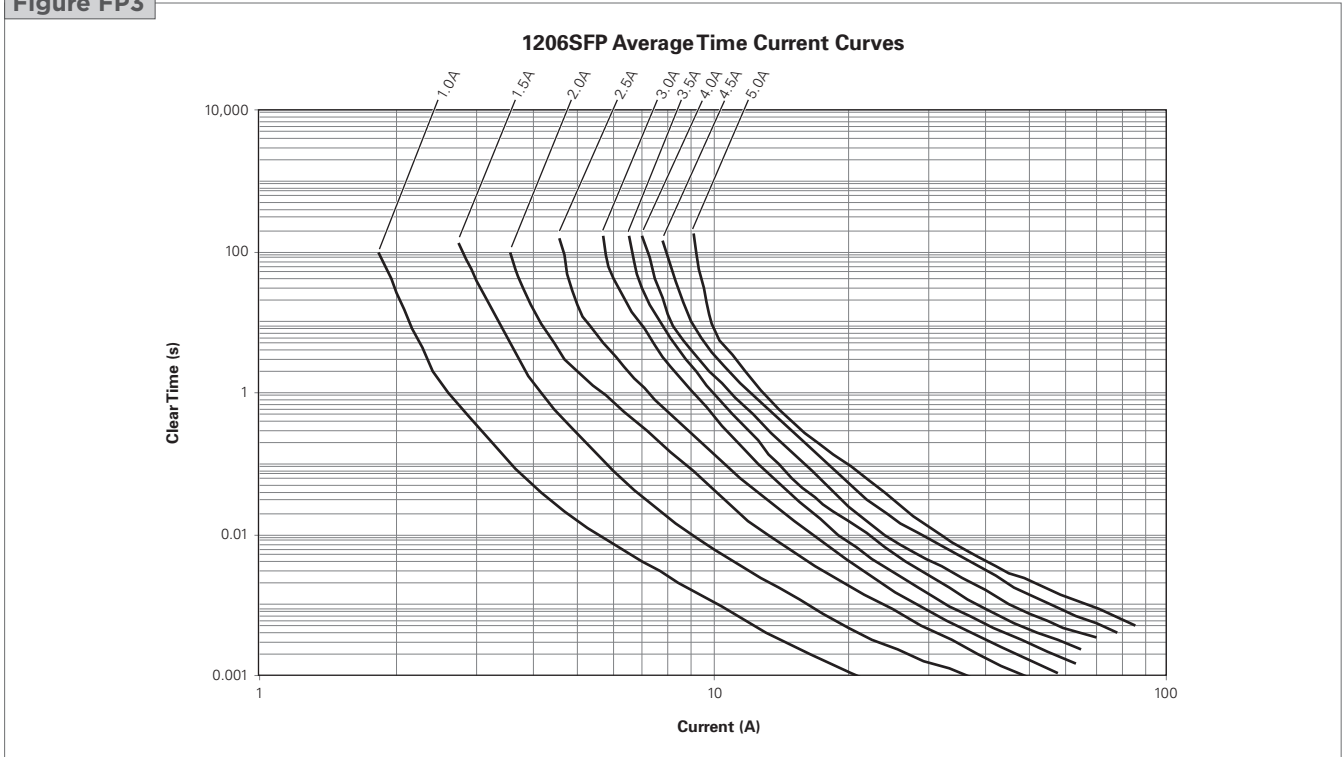
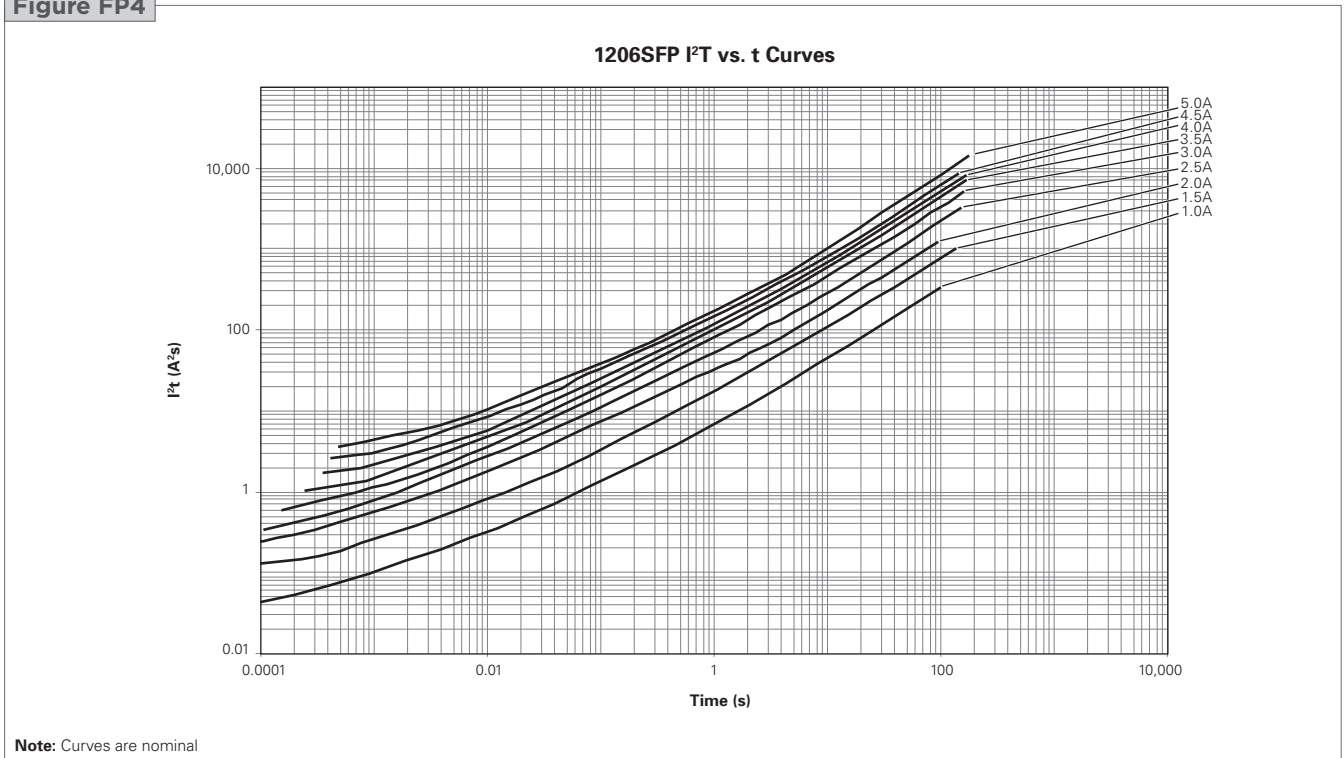


Figure FP4



→ Please go to page 97 for more information for Pulse Tolerant Chip Fuses.



Surface-mount Fuses

0603 Very Fast-Acting Chip Fuses



Very Fast-acting chip fuses help provide overcurrent protection on systems using DC power sources up to 32V_{DC}. The fuse's monolithic, multilayer design provides the highest hold current in the smallest footprint, reduces diffusion-related aging, improves product reliability and resilience, and enhances high-temperature performance in a wide range of circuit designs.

These RoHS-compliant surface-mount devices offer strong arc suppression characteristics and facilitate the development of more reliable, high performance consumer electronics such as laptops, multimedia devices, cell phones, and other portable electronics.



Benefits

- Very fast acting at 200% and 300% overloads
- Excellent inrush current withstanding capability at high overloads
- Thin body for space limiting applications
- Glass ceramic monolithic structure
- Silver fusing element and silver termination with nickel and tin plating
- RoHS compliant and lead-free materials
- Symmetrical design with marking on both sides (optional)

Features

- Lead free materials and RoHS compliant
- Halogen free
(refers to: Br≤900ppm, Cl≤900ppm, Br+Cl≤1500ppm)
- Monolithic, multilayer design
- High-temperature performance
- -55°C to +125°C operating temperature range

Applications

- | | | |
|-------------------|------------------------|----------------|
| • Laptops | • Printers | • Game systems |
| • Digital cameras | • DVD players | • LCD monitors |
| • Cell phones | • Portable electronics | • Scanners |

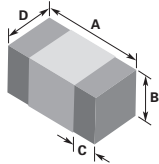
Table FV1 Clear Time Characteristics for Very Fast-Acting Chip Fuses

% of rated current	Clear time at 25°C	
100%	4 hours (min.)	
200%	0.01 second (min.)	5 seconds (max.)
300%	0.001 second (min.)	0.2 seconds (max.)

Table FV2 Typical Electrical Characteristics and Dimensions for Very Fast-Acting Chip Fuses

0603 (1608 mm) Very Fast-Acting Chip Fuses

Shape and Dimensions
mm (Inch)



	A		B		C		D	
	Min	Max	Min	Max	Min	Max	Min	Max
mm	1.45	1.75	0.22	0.48	0.21	0.51	0.65	0.95
in	(0.057)	(0.069)	(0.009)	(0.019)	(0.008)	(0.020)	(0.025)	(0.037)

Part Number	Typical Electrical Characteristics			Max. Interrupt Ratings	
	Rated Current (A)	Nominal Cold DCR (Ω)*	Nominal I ² t (A ² sec)	Voltage (V _{DC})	Current (A)
0603SFV050F/32-2	0.5	0.860	0.0093	32	50
0603SFV075F/32-2	0.8	0.450	0.0191	32	50
0603SFV100F/32-2	1.0	0.280	0.0360	32	50
0603SFV125F/32-2	1.3	0.205	0.0630	32	35
0603SFV150F/32-2	1.5	0.143	0.0950	32	35
0603SFV175F/32-2	1.8	0.095	0.1400	32	35
0603SFV200F/32-2	2.0	0.073	0.2100	32	35
0603SFV250F/32-2	2.5	0.046	0.3000	32	35
0603SFV300F/32-2	3.0	0.039	0.4600	32	35
0603SFV350F/32-2	3.5	0.028	0.7300	32	35
0603SFV400F/32-2	4.0	0.023	1.1500	32	35
0603SFV450F/32-2	4.5	0.019	1.6800	32	35
0603SFV500F/32-2	5.0	0.015	2.6200	32	35

* Measured at 10% of rated current and 25°C

Figure FV1-FV2 Family Performance Curves for Very Fast-Acting Chip Fuses

Figure FV1

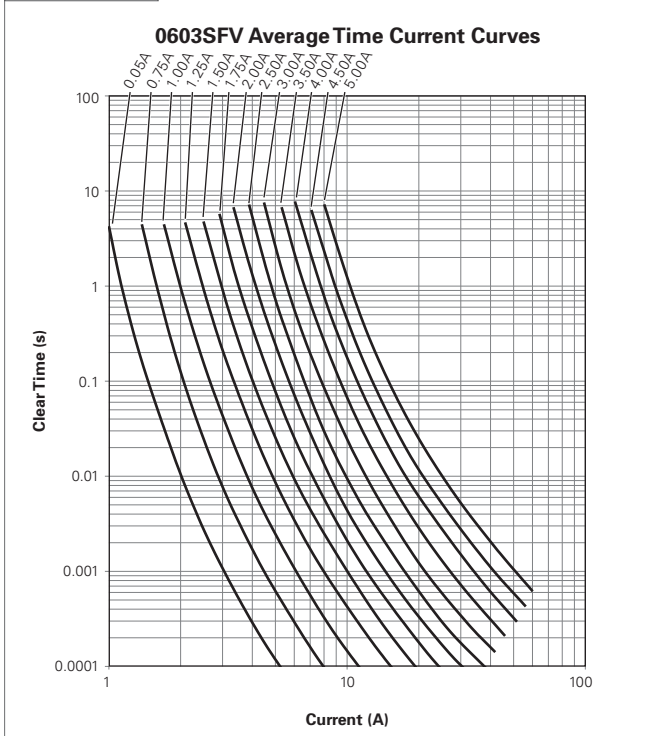
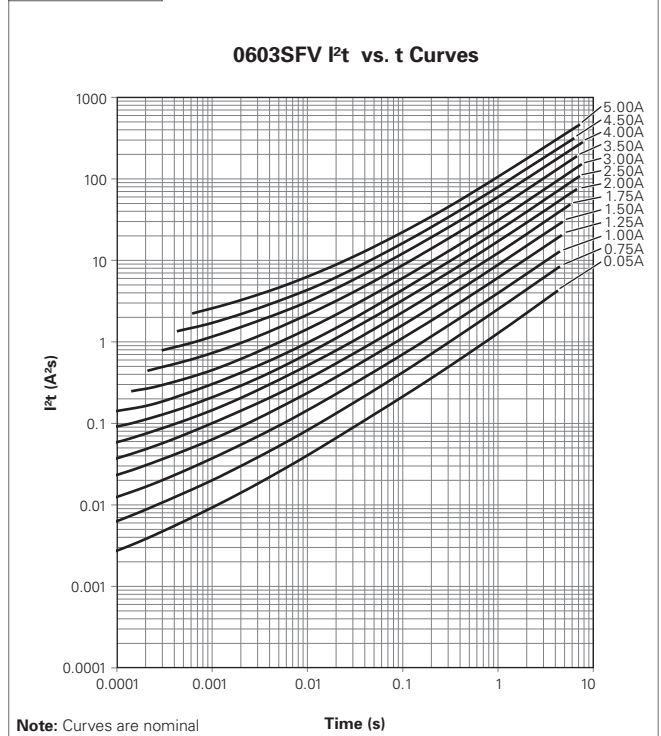


Figure FV2



Note: Curves are nominal

→ Please go to page 97 for more information for Very Fast-Acting Chip Fuses.



Surface-mount Fuses Fast-Acting Chip Fuses

Fast-acting chip fuses help provide overcurrent protection on systems using DC power sources up to 63V_{DC}. The fuse's monolithic, multilayer design provides the highest hold current in the smallest footprint, reduces diffusion-related aging, improves product reliability and resilience, and enhances high-temperature performance in a wide range of circuit designs.

These RoHS-compliant surface-mount devices offer strong arc suppression characteristics and facilitate the development of more reliable, high performance consumer electronics such as laptops, multimedia devices, cell phones, and other portable electronics.



Benefits

- Small size with high-current ratings
- Excellent temperature stability
- High reliability and resilience
- Strong arc suppression characteristics

Features

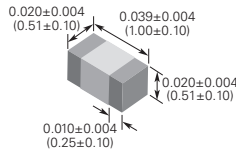
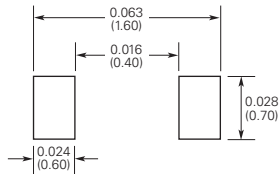
- Lead free materials and RoHS compliant
- Halogen free
(refers to: Br≤900ppm, Cl≤900ppm, Br+Cl≤1500ppm)
- Monolithic, multilayer design
- High-temperature performance
- -55°C to +125°C operating temperature range

Applications

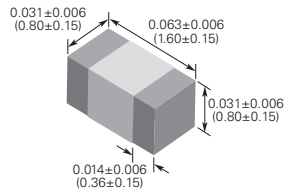
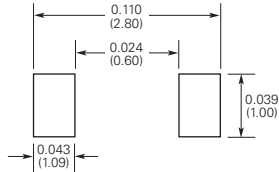
- | | | |
|-------------------|------------------------|----------------|
| • Laptops | • Printers | • Game systems |
| • Digital cameras | • DVD players | • LCD monitors |
| • Cell phones | • Portable electronics | • Scanners |

Table FF1 Clear Time Characteristics for Fast-Acting Chip Fuses

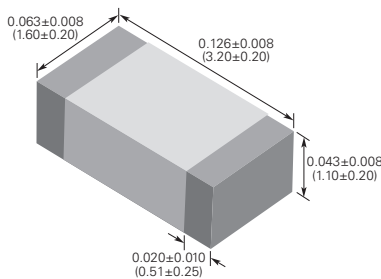
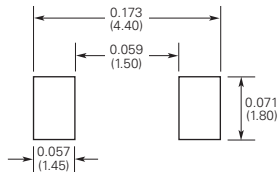
% of rated current	Clear time at 25°C
100%	4 hours min.
250%	5 seconds max.
400%	0.05 seconds max.

Table FF2 Typical Electrical Characteristics, Dimensions and Recommended Pad Layout for Fast-Acting Chip Fuses
0402 (1005mm) Fast-Acting Chip Fuses
Shape and Dimensions
Inch (mm)

Recommended Pad Layout
Inch (mm)

Typical Electrical Characteristics
Max. Interrupt Ratings

Part Number	Typical Electrical Characteristics			Max. Interrupt Ratings	
	Rated Current (A)	Nominal Cold DCR (Ω)*	Nominal I ² t (A ² sec) [†]	Voltage (V _{DC})	Current (A)
0402SFF050F/24	0.50	0.380	0.0043	24	35
0402SFF075F/24	0.75	0.210	0.0076	24	35
0402SFF100F/24	1.00	0.120	0.0170	24	35
0402SFF150F/24	1.50	0.056	0.0490	24	35
0402SFF200F/24	2.00	0.035	0.0700	24	35
0402SFF300F/24	3.00	0.021	0.1250	24	35
0402SFF400F/24	4.00	0.014	0.2250	24	35

0603 (1608mm) Fast-Acting Chip Fuses
Shape and Dimensions
Inch (mm)

Recommended Pad Layout
Inch (mm)

Typical Electrical Characteristics
Max. Interrupt Ratings

Part Number	Typical Electrical Characteristics			Max. Interrupt Ratings	
	Rated Current (A)	Nominal Cold DCR (Ω)*	Nominal I ² t (A ² sec) [†]	Voltage (V _{DC})	Current (A)
0603SFF050F/32	0.50	0.485	0.0029	32	50
0603SFF075F/32	0.75	0.254	0.0064	32	50
0603SFF100F/32	1.00	0.131	0.0160	32	50
0603SFF150F/32	1.50	0.059	0.0300	32	35
0603SFF200F/32	2.00	0.044	0.0600	32	35
0603SFF250F/32	2.50	0.032	0.1150	32	35
0603SFF300F/32	3.00	0.025	0.1900	32	35
0603SFF350F/32	3.50	0.024	0.2950	32	35
0603SFF400F/32	4.00	0.018	0.4000	32	35
0603SFF500F/32	5.00	0.013	0.7000	32	35
0603SFF600F/24	6.00	0.010	1.1250	24	35

1206 (3216mm) Fast-Acting Chip Fuses
Shape and Dimensions
Inch (mm)

Recommended Pad Layout
Inch (mm)

Typical Electrical Characteristics
Max. Interrupt Ratings

Part Number	Typical Electrical Characteristics			Max. Interrupt Ratings	
	Rated Current (A)	Nominal Cold DCR (Ω)*	Nominal I ² t (A ² sec) [†]	Voltage (V _{DC})	Current (A)
1206SFF050F/63	0.50	0.730	0.0021	63	50
1206SFF075F/63	0.75	0.513	0.0052	63	50
1206SFF100F/63	1.00	0.220	0.0120	63	50
1206SFF150F/63	1.50	0.120	0.0250	63	50
1206SFF175F/63	1.75	0.100	0.0450	63	50
1206SFF200F/63	2.00	0.050	0.0700	63	50
1206SFF250F/32	2.50	0.035	0.1400	32	50
1206SFF300F/32	3.00	0.031	0.2200	32	50
1206SFF400F/32	4.00	0.022	0.3800	32	45
1206SFF500F/32	5.00	0.015	0.6000	32	45
1206SFF600F/32	6.00	0.013	1.0000	32	50
1206SFF700F/32	7.00	0.011	1.7500	32	50
1206SFF800F/32	8.00	0.008	2.5000	32	50
1206SFF600F/24	6.00	0.013	1.0000	24	45
1206SFF700F/24	7.00	0.011	1.7500	24	45
1206SFF800F/24	8.00	0.008	2.5000	24	45

* Measured at ≤10% of rated current and 25°C ambient temperature.
† Melting I²t at 0.001 sec clear time.

Figure FF1-FF6 Family Performance Curves for Fast-Acting Chip Fuses

Figure FF1

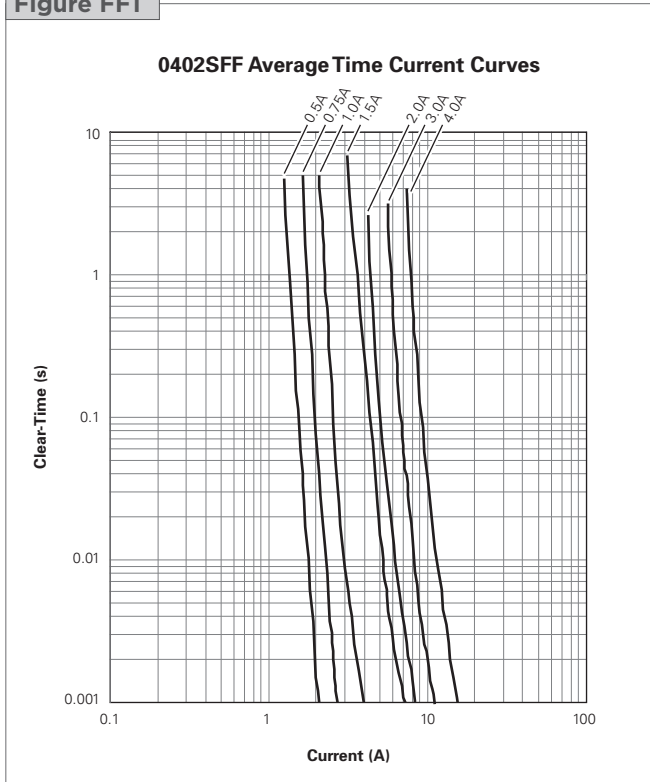


Figure FF2

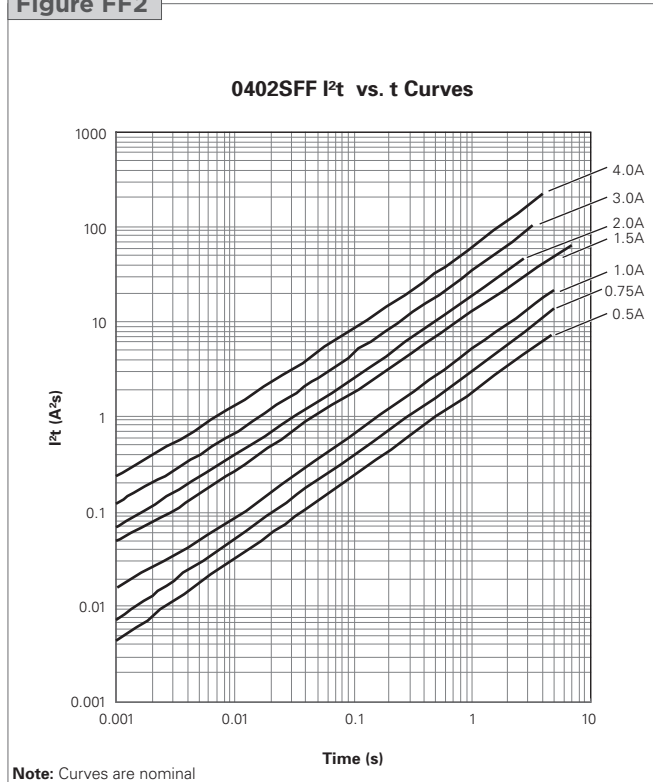


Figure FF3

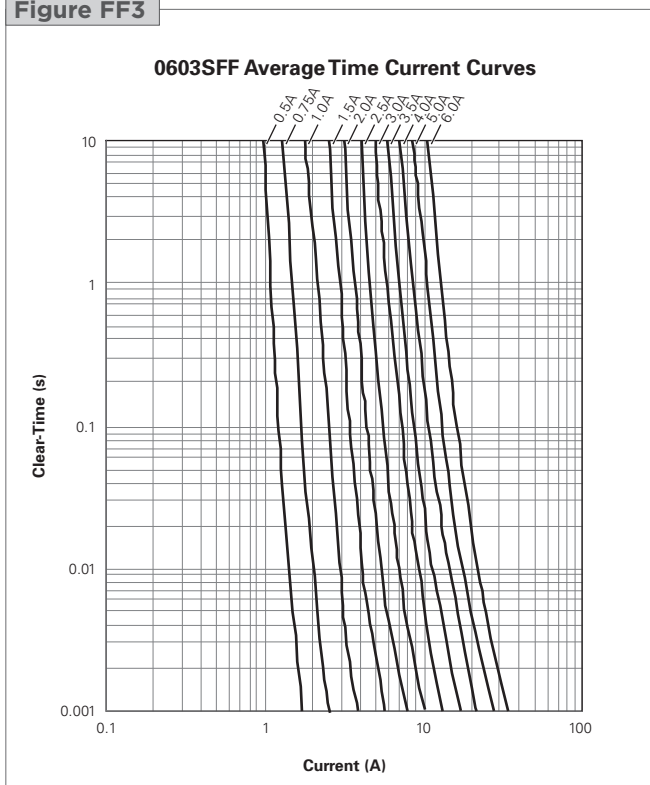


Figure FF4

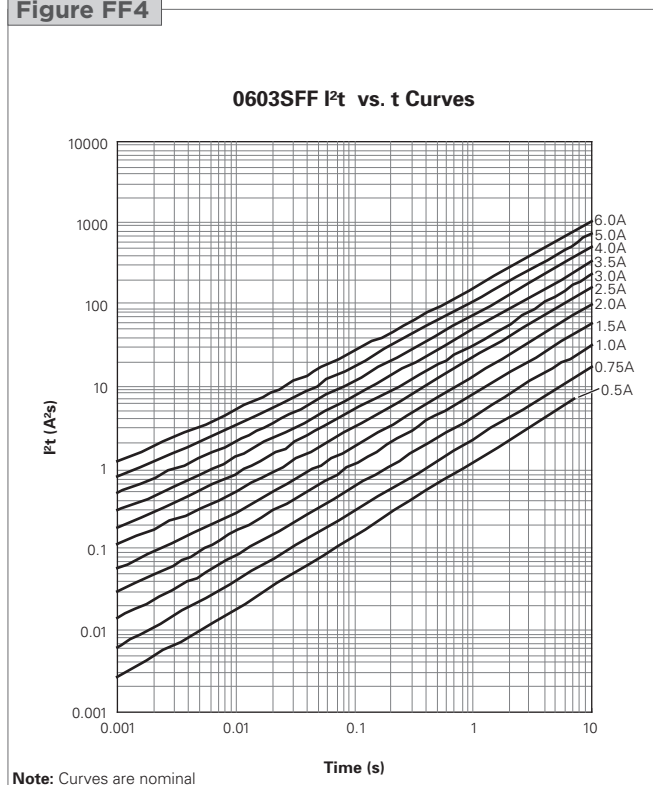


Figure FF5

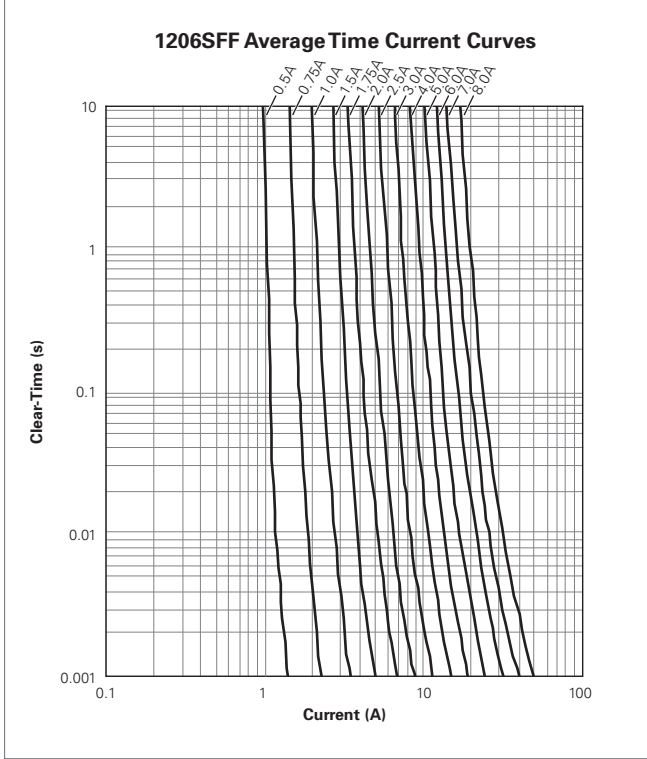
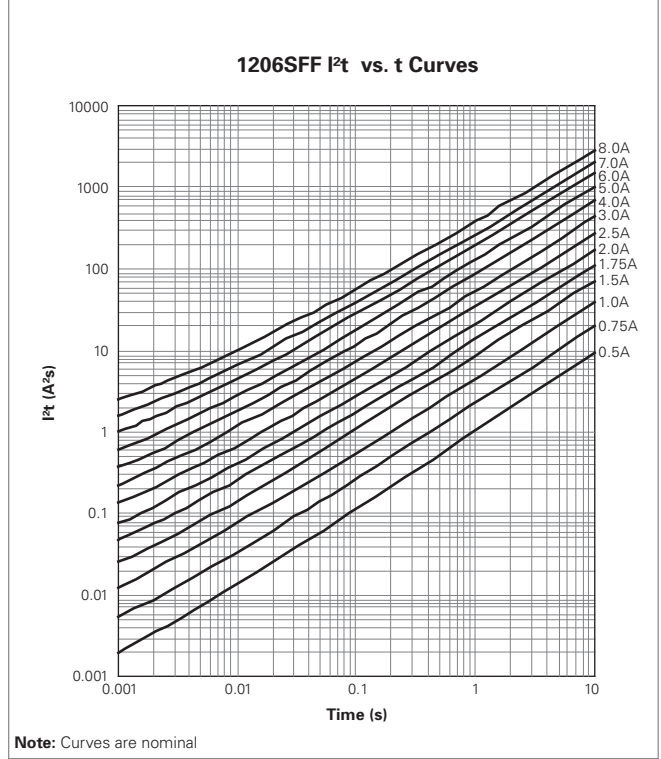


Figure FF6



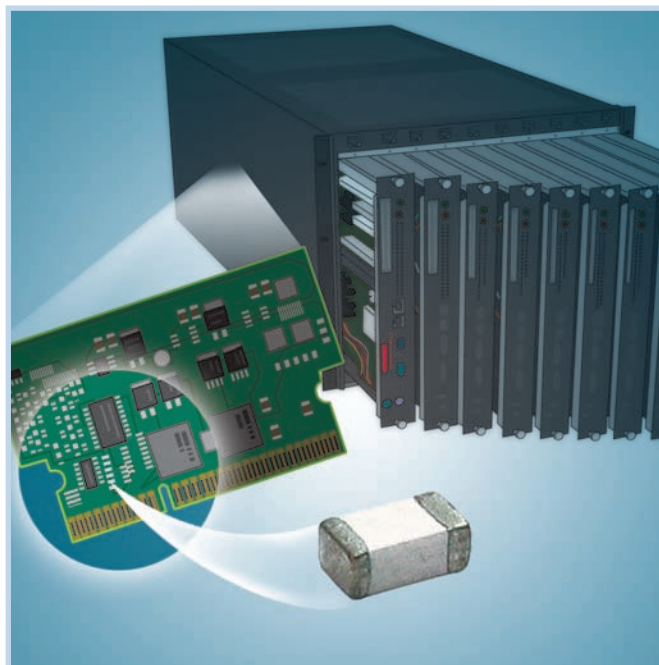
→ Please go to page 97 for more information for Fast-Acting Chip Fuses.



Surface-mount Fuses

High-Current-Rated Chip Fuses

The monolithic multilayer design of the TE Circuit Protection high-current-rated chip fuses helps to provide some of the highest current ratings available in the 1206 size and enhances high-temperature performance in a wide range of circuit protection designs. The devices' small size, high reliability and strong arc suppression characteristics make them suitable for overcurrent protection of power supplies, servers, communications equipment, voltage regulator modules, and other high-current, small size applications.



Benefits

- Glass ceramic monolithic structure provides stability in application cycling
- High-current rating in a small package allows more efficient use in system space
- Strong arc suppression in overcurrent conditions

Features

- Lead free materials and RoHS compliant
- Halogen free
(refers to: Br \leq 900ppm, Cl \leq 900ppm, Br+Cl \leq 1500ppm)
- Monolithic multilayer design
- High-temperature performance
- -55°C to +125°C operating temperature range

Applications

- Communications equipment
- Voltage regulator modules
- Power supplies
- Servers

Table FH1 Clear Time Characteristics for High-Current-Rated Chip Fuses

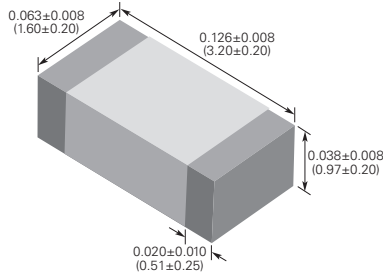
1206SFH Series

% of rated current	Clear time at 25°C
100%	4 hours (min.)
250%	5 seconds (max.)

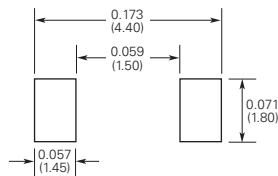
Table FH2 Typical Electrical Characteristics, Dimensions and Recommended Pad Layout for High-Current-Rated Chip Fuses

1206 (3216mm) High-Current-Rated Chip Fuses

Shape and Dimensions
Inch (mm)



Recommended Pad Layout
Inch (mm)



Typical Electrical Characteristics

Max. Interrupt Ratings

Part Number	Typical Electrical Characteristics			Max. Interrupt Ratings	
	Rated Current (A)	Nominal Cold DCR (Ω)*	Nominal I ² t (A ² sec) [†]	Voltage (V _{DC})	Current (A)
1206SFH100F/24	10	0.010	9	24	100
1206SFH120F/24	12	0.008	14	24	100
1206SFH150F/24	15	0.005	26	24	100
1206SFH200F/24	20	0.003	56	24	100

* Measured at ≤10% of rated current and 25°C ambient temperature.
† Melting I²t at 0.001 sec clear time.

Figure FH1-FH2 Family Performance Curves for High-Current-Rated Chip Fuses

Figure FH1

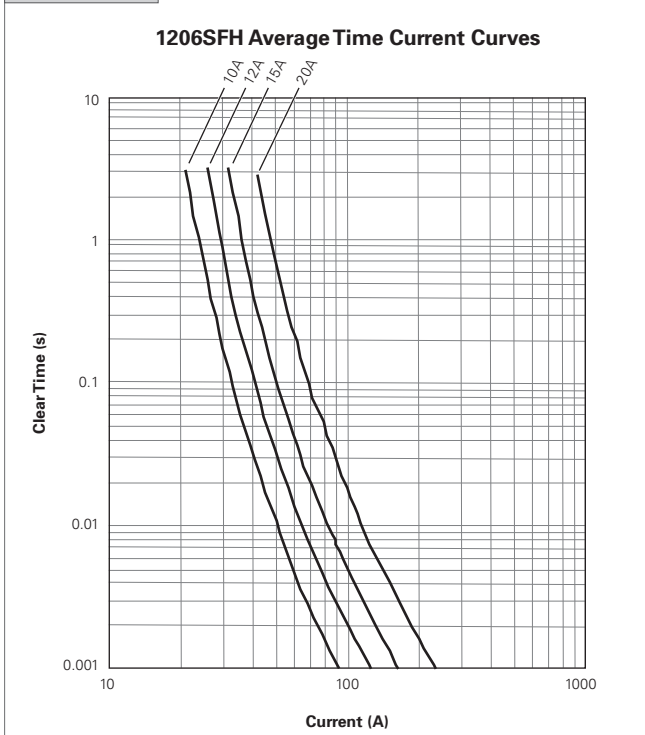
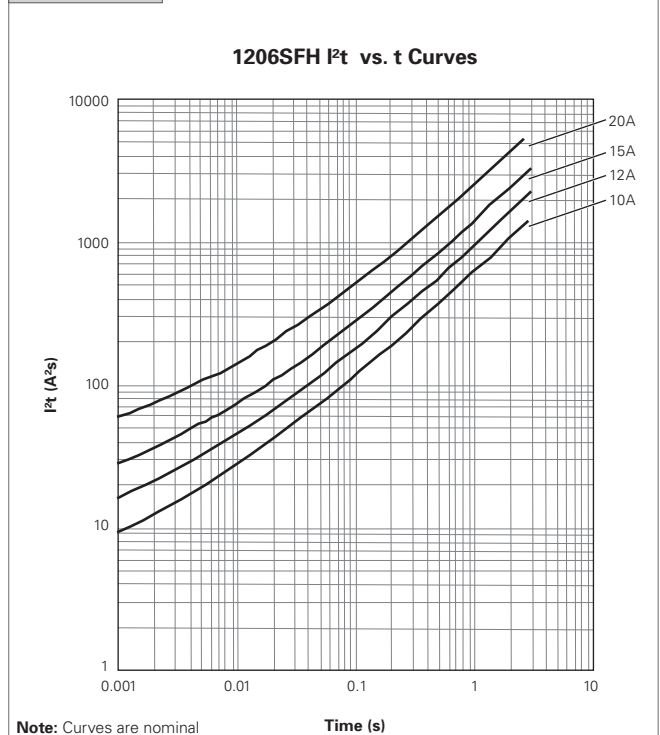


Figure FH2



→ Please go to page 97 for more information for High-Current-Rated Chip Fuses.



Surface-mount Fuses Slow-Blow Chip Fuses

Available in industry standard 1206 and 0603 chip sizes, TE Circuit Protection’s slow-blow chip fuses help provide overcurrent protection on systems that experience large and frequent current surges as part of their normal operation.

The slow-blow chip fuse’s monolithic, multilayer design helps provide some of the highest current ratings available in the 1206 and 0603 footprints and enhances high-temperature performance in a wide range of circuit protection designs. The devices’ small size, high reliability and strong arc suppression characteristics make them suitable for overcurrent protection of power supplies, capacitor filter banks, LCD (Liquid Crystal Display) backlight inverters, electric motors and portable electronics.



Benefits

- Time-delayed design prevents nuisance openings in pulsed and high inrush current applications
- Small size with high-current ratings
- Strong arc suppression characteristics

Features

- Lead free materials and RoHS compliant
- Halogen free
(refers to: Br≤900ppm, Cl≤900ppm, Br+Cl≤1500ppm)
- Monolithic multilayer design
- High-temperature performance
- -55°C to +125°C operating temperature range

Applications

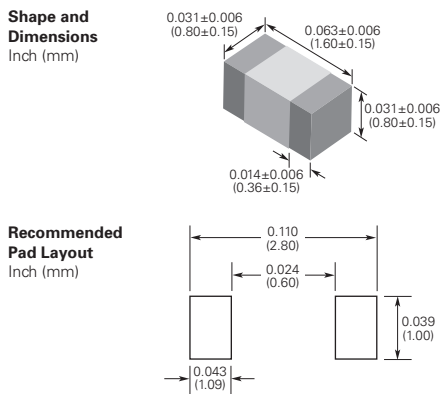
- | | | |
|------------------------|-----------------------------|-------------------|
| • Small motors systems | • Power over Ethernet (POE) | • Computer drives |
| • Portable electronics | • Test equipment | • Displays |
| • Input power ports | • POL converter protection | • Printers |

Table FS1 Clear Time Characteristics for Slow-Blow Chip Fuses
0603SFS Series

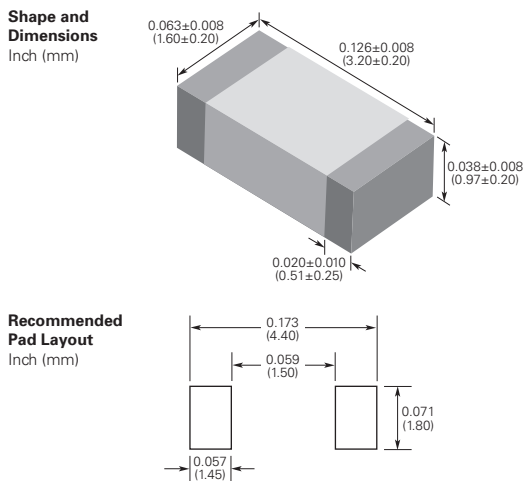
% of rated current	Clear time at 25°C	
100%	4 hours (min.)	
200%	1 second (min.)	120 seconds (max.)
300%	0.1 second (min.)	3 seconds (max.)
800%(1.0A-1.5A)	0.0005 second (min.)	0.05 seconds (max.)
800%(2.0A-5.0A)	0.001 second (min.)	0.05 seconds (max.)

1206SFS Series

% of rated current	Clear time at 25°C	
100%	4 hours (min.)	
200%	1 second (min.)	120 seconds (max.)
300%	0.1 second (min.)	3 seconds (max.)
800%(1.0A-1.5A)	0.0016 second (min.)	0.05 seconds (max.)
800%(2.0A-8.0A)	0.002 second (min.)	0.05 seconds (max.)

Table FS2 Typical Electrical Characteristics, Dimensions and Recommended Pad Layout for Slow-Blow Chip Fuses
0603 (1608mm) Slow-Blow Chip Fuses


Part Number	Typical Electrical Characteristics			Max. Interrupt Ratings	
	Rated Current (A)	Nominal Cold DCR (Ω)*	Nominal I ² t (A ² sec) [†]	Voltage (V _{DC})	Current (A)
0603SFS100F/32	1.0	0.200	0.093	32	50
0603SFS150F/32	1.5	0.100	0.18	32	50
0603SFS200F/32	2.0	0.052	0.32	32	50
0603SFS250F/32	2.5	0.041	0.63	32	50
0603SFS300F/32	3.0	0.031	0.87	32	50
0603SFS350F/32	3.5	0.021	1.20	32	50
0603SFS400F/32	4.0	0.017	2.30	32	50
0603SFS450F/32	4.5	0.015	2.70	32	50
0603SFS500F/32	5.0	0.013	3.20	32	50

1206 (3216mm) Slow-Blow Chip Fuses


Part Number	Typical Electrical Characteristics			Max. Interrupt Ratings	
	Rated Current (A)	Nominal Cold DCR (Ω)*	Nominal I ² t (A ² sec) [†]	Voltage (V _{DC})	Current (A)
1206SFS100F/63	1.0	0.360	0.11	63	50
1206SFS125F/63	1.25	0.200	0.22	63	50
1206SFS150F/63	1.5	0.150	0.23	63	50
1206SFS200F/63	2.0	0.088	0.63	63	50
1206SFS250F/32	2.5	0.065	0.90	32	50
1206SFS300F/32	3.0	0.034	1.20	32	50
1206SFS350F/32	3.5	0.028	1.60	32	50
1206SFS400F/32	4.0	0.024	2.20	32	50
1206SFS450F/32	4.5	0.020	3.60	32	50
1206SFS500F/32	5.0	0.016	5.30	32	50
1206SFS550F/24	5.5	0.014	6.40	24	50
1206SFS600F/24	6.0	0.011	8.50	24	60
1206SFS700F/24	7.0	0.010	10.00	24	60
1206SFS800F/24	8.0	0.009	16.90	24	60

* Measured at ≤10% of rated current and 25°C ambient temperature.
[†] Melting I²t at 0.001 sec clear time.

Figure FS1-FS4 Family Performance Curves for Slow-Blow Chip Fuses

Figure FS1

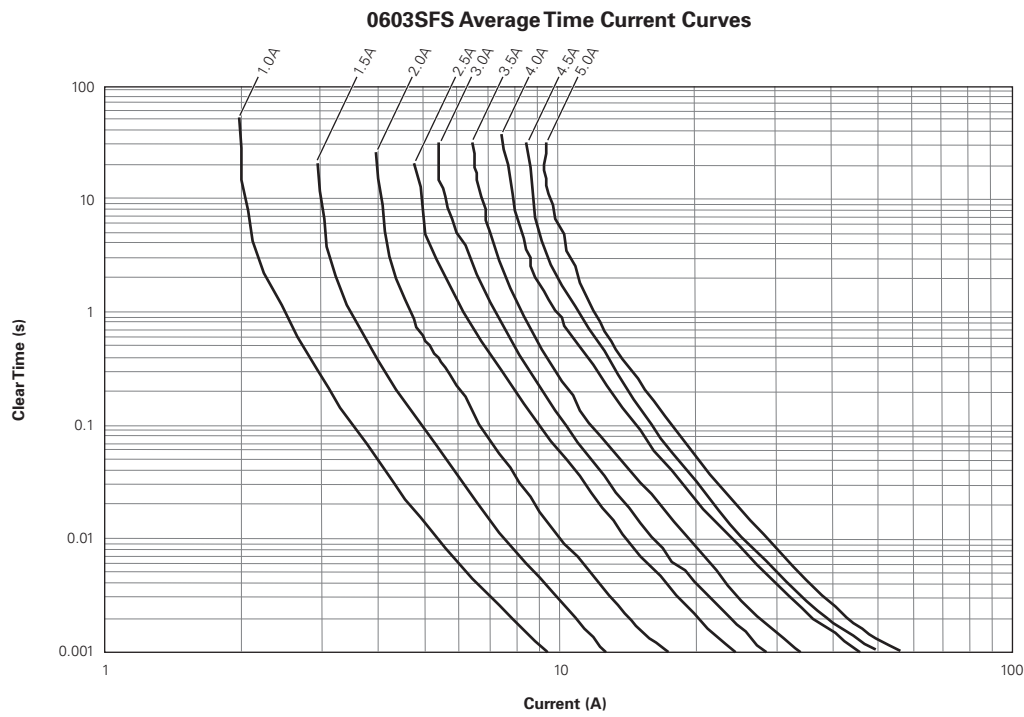
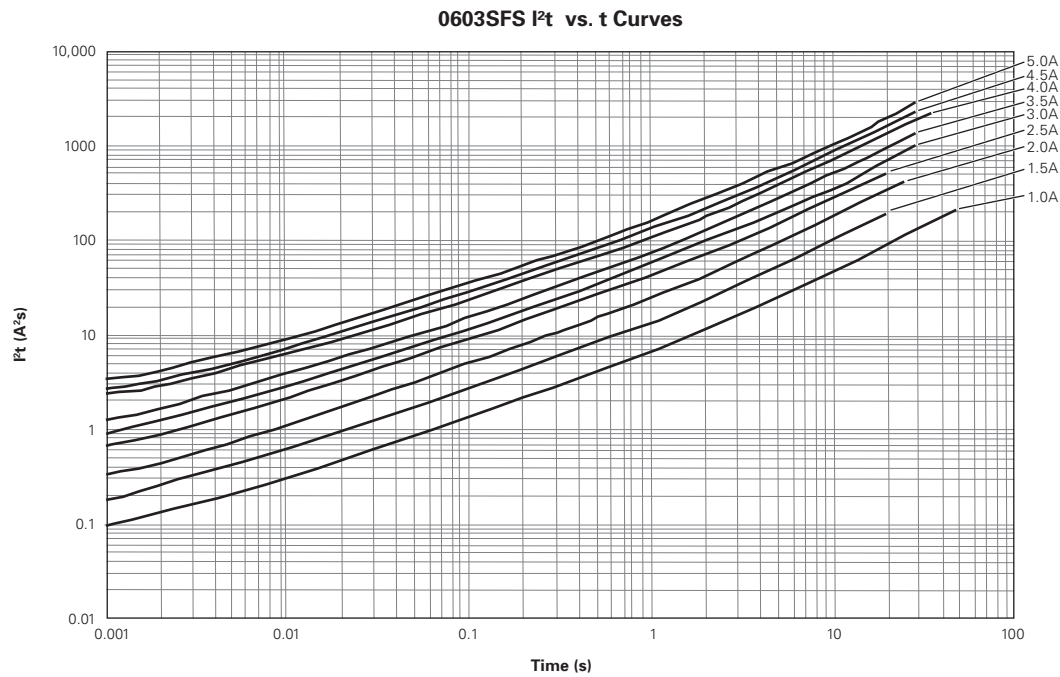


Figure FS2



Note: Curves are nominal

Figure FS3

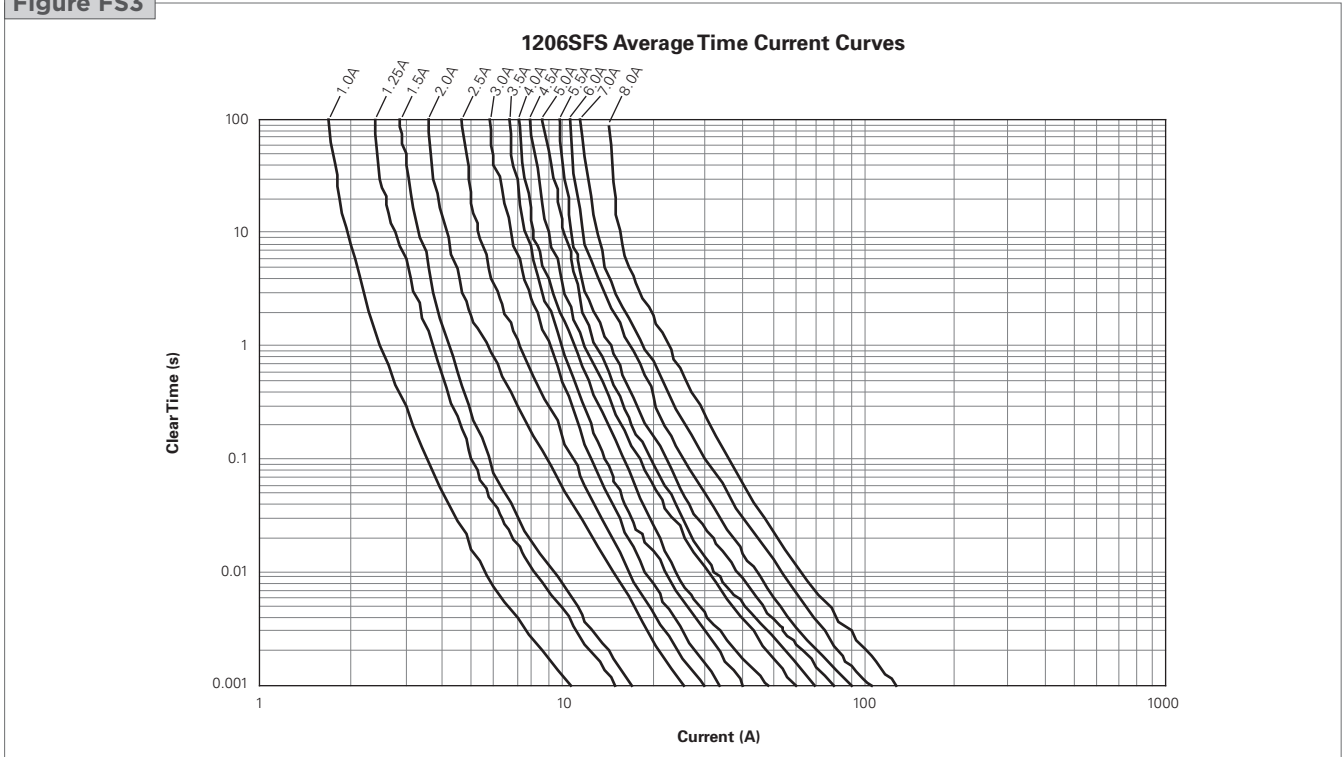
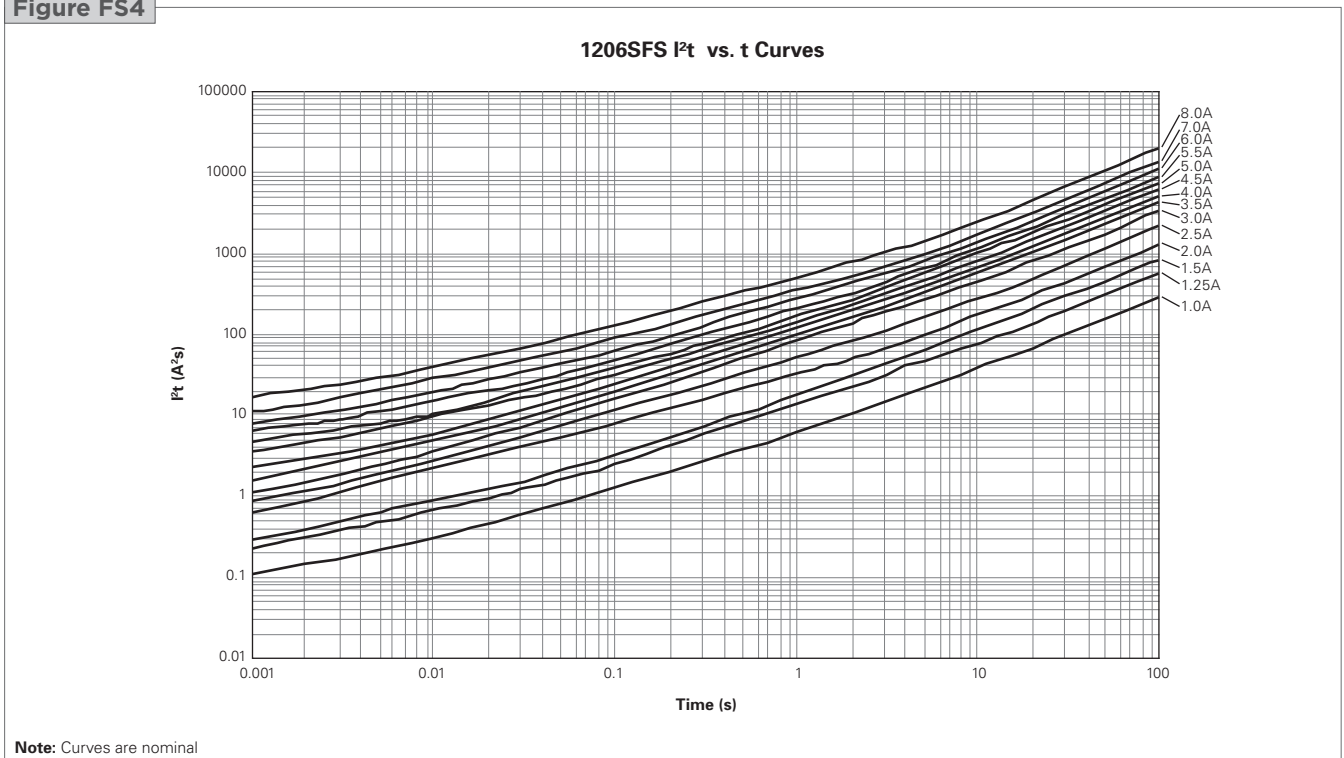


Figure FS4



11

→ Please go to page 97 for more information for Slow-Blow Chip Fuses.



Surface-mount Fuses

2410 Very Fast-Acting Fuses



The 2410(6125) is Wire-in Air SMD Fuse which is very suitable for secondary level overcurrent protection applications.

These lead-free surface mount devices offer more reliability and have no end cap falling off risk. Straight wire element in air performs consistent fusing and cutting characteristics.



Benefits

- Very fast acting at 200% overload current level
- Excellent inrush current withstanding capability
- High reliability and resilience
- Strong arc suppression characteristics
- Copper terminal with nickel and tin plated

Features

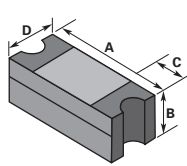
- Halogen free, RoHS compliant and 100% lead-free
- Copper or copper alloy composite fuse link
- Fiberglass enforced epoxy fuse body
- Wide range of current rating
- -55°C to +125°C operating temperature range (with de-rating)

Applications

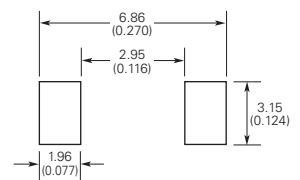
- | | | |
|------------------------|------------------|----------------|
| • Industrial equipment | • Power supplier | • Game systems |
| • LCD/PDP TV | • Telecom system | • White goods |
| • Backlight inverter | • Networking | • Automotive |

Table SFV1 Clear Time Characteristics for 2410 Very Fast-Acting Fuses

% of rated current	Clear time at 25°C	
	100%	4 hours (min.)
200% (0.5A-10.0A)	0.01 second (min.)	5 seconds (max.)
200% (12.0A-20.0A)	0.01 second (min.)	20 seconds (max.)

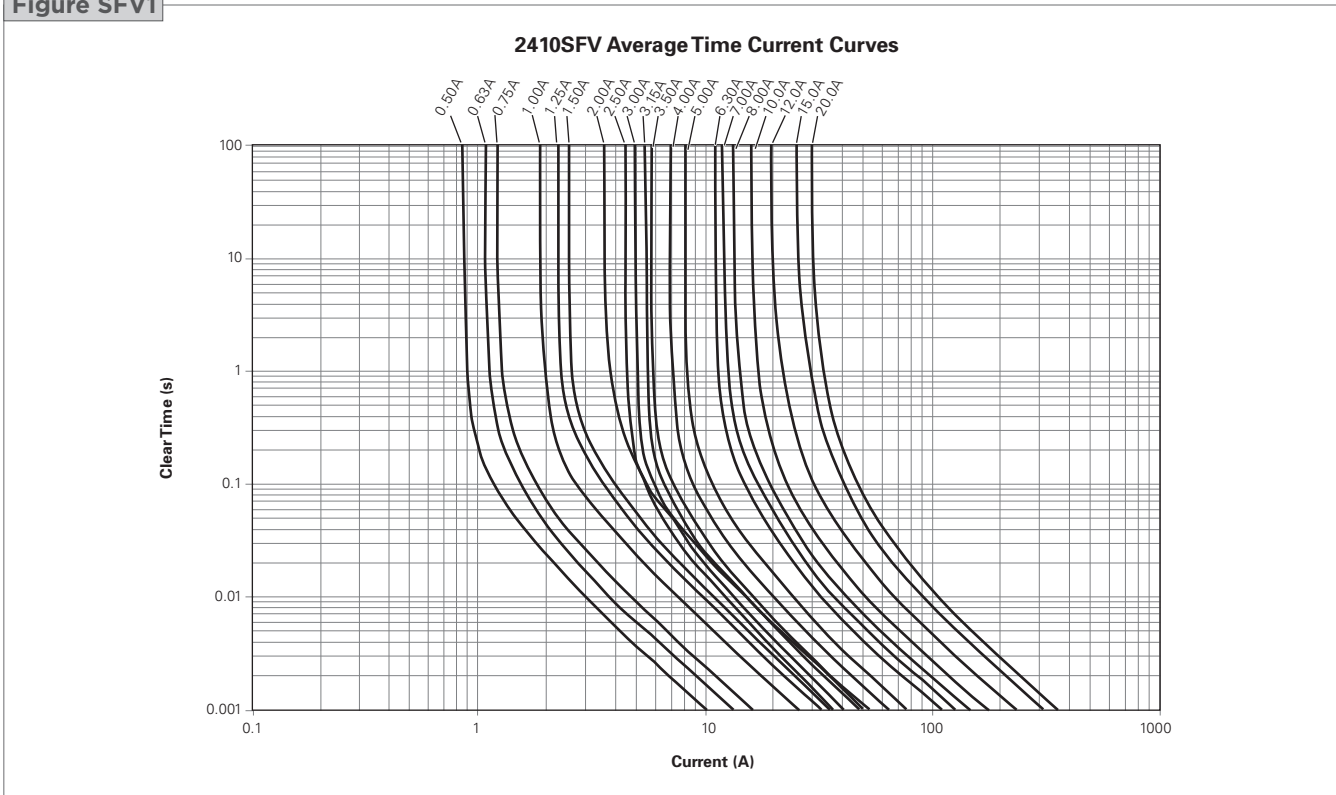
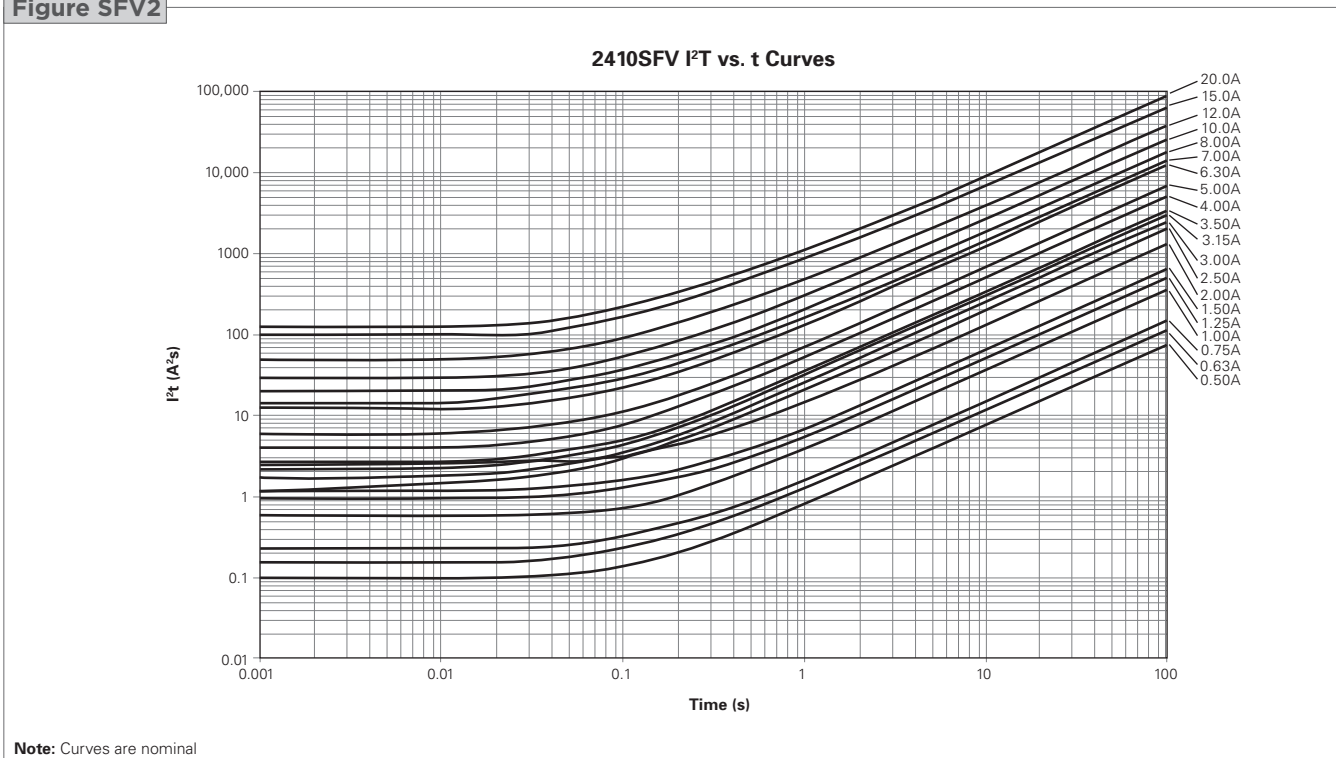
Table SFV2 Typical Electrical Characteristics, Dimensions and Recommended Pad Layout for 2410 Very Fast-Acting Fuses
2410 (6125 mm) Very Fast-Acting Fuse
Shape and Dimensions
mm (Inch)


	A		B		C		D	
	Min	Max	Min	Max	Min	Max	Min	Max
mm	5.95	6.25	1.96	2.36	0.97	1.73	2.34	2.64
in	(0.234)	(0.246)	(0.077)	(0.093)	(0.038)	(0.068)	(0.092)	(0.104)

Recommended Pad Layout
mm (Inch)

Typical Electrical Characteristics
Max. Interrupt Ratings

Part Number	Marking Code	Rated Current (A)	Nominal Cold DCR (Ω)*	Nominal I ² t (A ² sec)	Voltage		Current (A)
					(V _{AC})	(V _{DC})	
2410SFV0.50FM/125-2	C	0.5	0.2310	0.10	250	125	50A @ 250V _{AC} 50A @ 125V _{DC} 300A @ 32V _{DC}
2410SFV0.63FM/125-2	S	0.6	0.1740	0.16	250	125	
2410SFV0.75FM/125-2	D	0.8	0.1480	0.23	250	125	
2410SFV1.00FM/125-2	E	1.0	0.0930	0.59	250	125	
2410SFV1.25FM/125-2	F	1.3	0.0700	0.96	250	125	
2410SFV1.50FM/125-2	G	1.5	0.0620	1.19	125	125	50A @ 125V _{AC} 50A @ 125V _{DC} 300A @ 32V _{DC}
2410SFV2.00FM/125-2	I	2.0	0.0420	2.75	125	125	
2410SFV2.50FM/125-2	J	2.5	0.0310	1.21	125	125	
2410SFV3.00FM/125-2	K	3.0	0.0249	1.73	125	125	
2410SFV3.15FM/125-2	V	3.2	0.0232	2.20	125	125	
2410SFV3.50FM/125-2	L	3.5	0.0220	2.50	125	125	
2410SFV4.00FM/125-2	M	4.0	0.0172	4.10	125	125	
2410SFV5.00FM/125-2	N	5.0	0.0143	5.90	125	125	
2410SFV6.30FM/125-2	O	6.3	0.0100	12.50	125	125	
2410SFV7.00FM/125-2	P	7.0	0.0094	14.20	125	125	
2410SFV8.00FM/125-2	R	8.0	0.0086	20.30	125	125	35A @ 125V _{AC} 50A @ 125V _{DC} 300A @ 32V _{DC}
2410SFV10.0FM/125-2	Q	10.0	0.0066	29.20	125	125	
2410SFV12.0FM/065-2	X	12.0	0.0053	49.20	65	65	
2410SFV15.0FM/065-2	Y	15.0	0.0038	102.50	65	65	
2410SFV20.0FM/065-2	Z	20.0	0.0034	126.20	65	65	50A @ 65V _{AC} 50A @ 65V _{DC} 300A @ 32V _{DC}

* Measured at ≤10% of rated current and 25°C ambient temperature.

Figure SFV1-SFV2 Family Performance Curves for 2410 Very Fast-Acting Fuses
Figure SFV1

Figure SFV2


→ Please go to page 97 for more information for 2410 Fast-Acting Fuses.

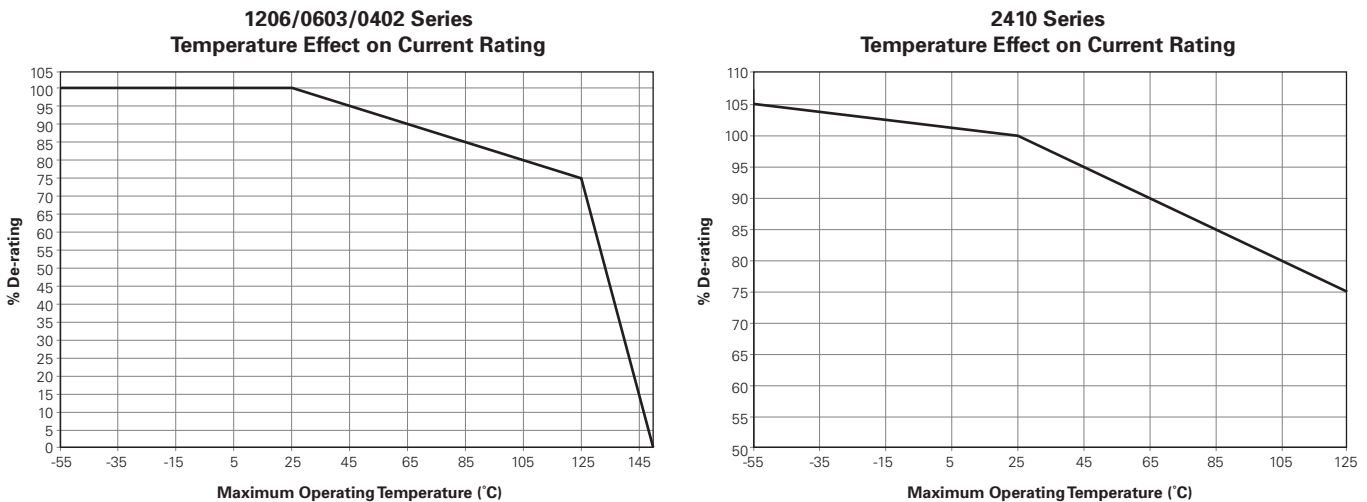
Specifications, Packaging Information, Agency Approvals and Part Numbering Systems for All Fuses

Table F1 Environmental Specifications for All Fuses

Operating temperature	-55°C to +125°C
Mechanical vibration	Withstands 5-3000 Hz at 30 Gs when evaluated per Method 204 of MIL-STD-202
Mechanical shock	Withstands 1500 Gs, 0.5 millisecond half-sine pulses when evaluated per Method 213 of MIL-STD-202
Thermal shock	Withstands 100 cycles from -65°C to +125°C when evaluated per Method 107 of MIL-STD-202
Resistance to soldering heat	Withstands 60 seconds at +260°C when evaluated per Method 210 of MIL-STD-202
Solderability	Meets 95% minimum coverage requirement when evaluated per Method 208 of MIL-STD-202
Moisture resistance	Withstands 10 cycles when evaluated per Method 106 of MIL-STD-202
Salt spray	Withstands 48-hour exposure when evaluated per Method 101 of MIL-STD-202
Storage temperature	≤30°C/ 85% RH
Storage humidity	Per MIL-STD-202F, Method 106F

Table F2 Material Specifications for All Fuses

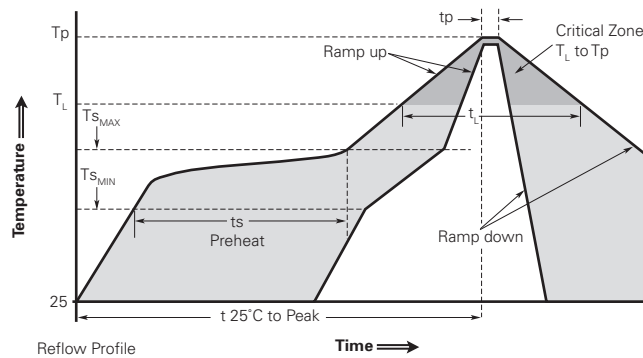
Construction body material	Ceramic (1206/0603/0402); Fiberglass/Epoxy (2410)
Termination material	Silver, Nickel, Tin
Fuse element	Silver(1206/0603/0402); Copper/Copper Alloy (2410)

Figure F1 Thermal Derating Current for All Fuses

Table F3 Electrical Specifications for All Fuses

Insulation resistance after opening	20,000Ω minimum @ rated voltage. Fuse clearing under low voltage conditions may result in lower - post-clearing insulation values. Under normal fault conditions TE Circuit Protection fuses provide sufficient insulation resistance for circuit protection.
Current carrying capacity	Withstands 100% rated current at +25°C ambient for 4 hours when evaluated per MIL-PRF-23419.

Table F4 Packaging Information for All Fuses

Size	Reel Quantity (pcs)	Reel Diameter	Reel Width	Carrier Tape Size	Tape Type	Reels per Outside Shipment Box	Outside Shipment Boxes per Overpack
0402(1005)	10,000	178mm white plastic	9.0 ± 0.5mm	8.00 ± 0.10mm	Paper	5	1 to 10
0603(1608)	4,000	178mm white plastic	9.0 ± 0.5mm	8.00 ± 0.10mm	Paper	5	1 to 10
0603SFV(1608)	6,000	178mm white plastic	9.0 ± 0.5mm	8.00 ± 0.10mm	Paper	5	1 to 10
1206(3216)	3,000	178mm white plastic	9.0 ± 0.5mm	8.00 ± 0.10mm	Plastic	5	1 to 10
2410(6125)	2,000	178mm white plastic	13.4 ± 0.5mm	12.00 ± 0.10mm	Plastic	4	1 to 10

Figure F2 Recommended Soldering Temperature Profile for All Fuses

Classification Reflow Profiles

Profile Feature	1206/0603/0402	2410
Average ramp up rate ($T_{S_{MAX}}$ to T_p)	3°C/second max.	3°C/second max.
Preheat		
• Temperature min. ($T_{S_{MIN}}$)	150°C	150°C
• Temperature max. ($T_{S_{MAX}}$)	200°C	200°C
• Time ($t_{S_{MIN}}$ to $t_{S_{MAX}}$)	60-180 seconds	40-100 seconds
Time maintained above:		
• Temperature (T_L)	217°C	200°C
• Time (t_L)	60-150 seconds	30-90 seconds
Peak/Classification temperature (T_p)	260°C max.	250°C max.
Time within 5°C of actual peak temperature		
Time (t_p)	20-40 seconds	30-40 seconds
From 25°C to preheating (150°C)	8 minutes max.	40-100 seconds
Ramp down rate	4°C/second max.	Natural cooling

Recommended conditions for hand soldering:

- Using hot air rework station that can reflow the solder on both terminations at the same time is strongly recommended, do not directly contact the chip termination with the tip of soldering iron.
- Preheating: 150°C, 60s (min).
Appropriate temperature (max) of soldering iron tip/soldering time (max): 280°C / 10s or 350°C / 3s.

Table F5 Tape and Reel Specifications for All Fuses

Mark	Dimension in inches (mm)				
	0402 (1005)	0603 (1608)	1206 (3216)	0603SFV (1608)	2410 (6125)
E ₁	0.069 ± 0.004 (1.75 ± 0.10)	0.069 ± 0.004 (1.75 ± 0.10)	0.069 ± 0.004 (1.75 ± 0.10)	0.069 ± 0.004 (1.75 ± 0.10)	0.069 ± 0.004 (1.75 ± 0.10)
F	0.138 ± 0.002 (3.50 ± 0.05)	0.138 ± 0.002 (3.50 ± 0.05)	0.138 ± 0.002 (3.50 ± 0.05)	0.138 ± 0.002 (3.50 ± 0.05)	0.217 ± 0.004 (5.50 ± 0.10)
W	0.315 ± 0.004 (8.00 ± 0.10)	0.315 ± 0.004 (8.00 ± 0.10)	0.315 ± 0.004 (8.00 ± 0.10)	0.315 ± 0.004 (8.00 ± 0.10)	0.472 ± 0.004 (12.00 ± 0.10)
P ₁	0.079 ± 0.004 (2.00 ± 0.10)	0.157 ± 0.004 (4.00 ± 0.10)	0.157 ± 0.004 (4.00 ± 0.10)	0.157 ± 0.004 (4.00 ± 0.10)	0.157 ± 0.004 (4.00 ± 0.10)
P ₀	0.157 ± 0.004 (4.00 ± 0.10)	0.157 ± 0.004 (4.00 ± 0.10)	0.157 ± 0.004 (4.00 ± 0.10)	0.157 ± 0.004 (4.00 ± 0.10)	0.157 ± 0.004 (4.00 ± 0.10)
P ₂	0.079 ± 0.002 (2.00 ± 0.05)	0.079 ± 0.002 (2.00 ± 0.05)	0.079 ± 0.002 (2.00 ± 0.05)	0.079 ± 0.002 (2.00 ± 0.05)	0.079 ± 0.004 (2.00 ± 0.10)
D ₀	0.059 ± 0.004 (1.50+0.10/-0.00)	0.059 ± 0.004 (1.50+0.10/-0.00)	0.059 ± 0.004 (1.50+0.10/-0.00)	0.059 ± 0.004 (1.50+0.10/-0.00)	0.059 ± 0.004 (1.50+0.10/-0.00)
D ₁	—	—	0.039 max (1.00 max)	—	0.61 ± 0.004 (1.55 ± 0.10)
t	—	—	0.009 ± 0.001 (0.23 ± 0.02)	—	0.010 ± 0.002 (0.25 ± 0.05)
A ₀	0.026 ± 0.004 (0.67 ± 0.10)	0.039 ± 0.004 (0.98 ± 0.10)	0.071 ± 0.004 (1.80 ± 0.10)	0.039 ± 0.004 (0.98 ± 0.10)	0.112 ± 0.004 (2.85 ± 0.10)
B ₀	0.046 ± 0.004 (1.17 ± 0.10)	0.071 ± 0.004 (1.80 ± 0.10)	0.138 ± 0.004 (3.50 ± 0.10)	0.071 ± 0.004 (1.80 ± 0.10)	0.252 ± 0.004 (6.40 ± 0.10)
K ₀	0.025 ± 0.004 (0.63 ± 0.10)	0.037 ± 0.003 (0.95 ± 0.08)	0.050 ± 0.004 (1.27 ± 0.10)	0.024 ± 0.003 (0.60 ± 0.08)	0.093 ± 0.004 (2.35 ± 0.10)

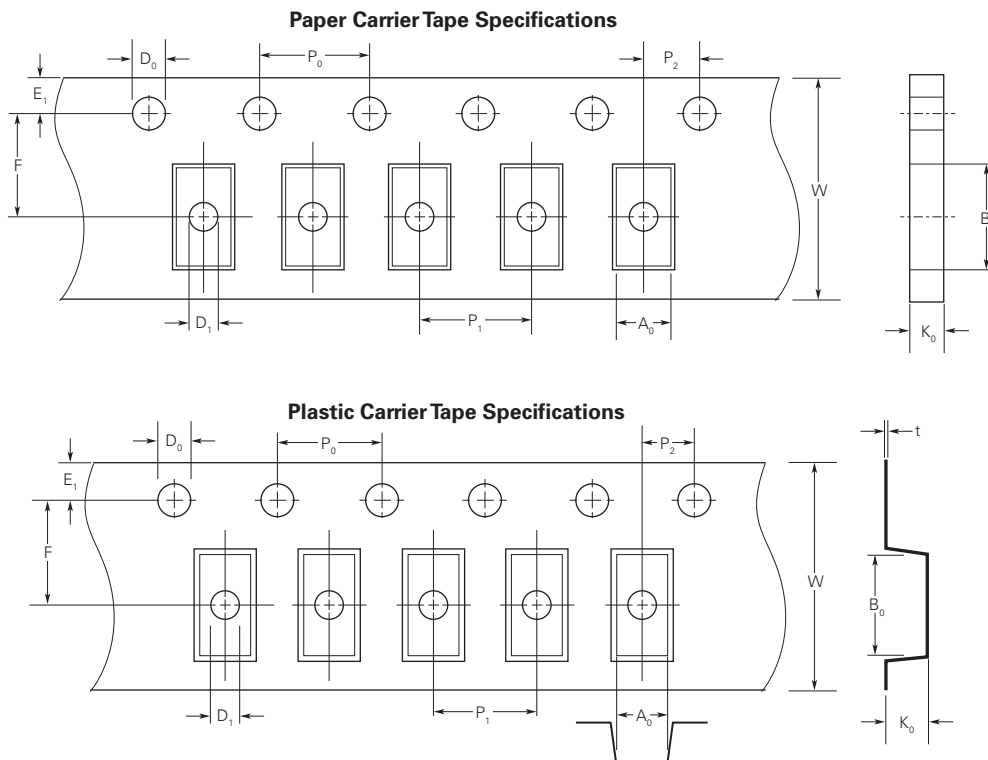
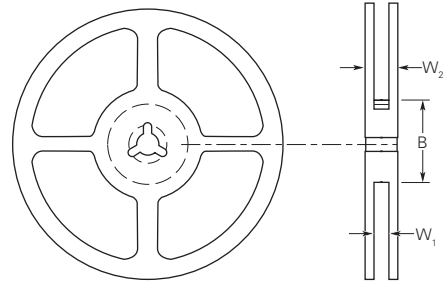
Figure F3 Component Tape Dimensions for All Fuses


Figure F4 Reel Dimensions for All Fuses

Dimension Description	Mark	Dimension (mm)	
		1206/0603/0402	2410
Hub outer diameter	B	60	60.2
Reel inside width	W_1	9	13.4
Reel outside width	W_2	11.4	16
Tape width		8	

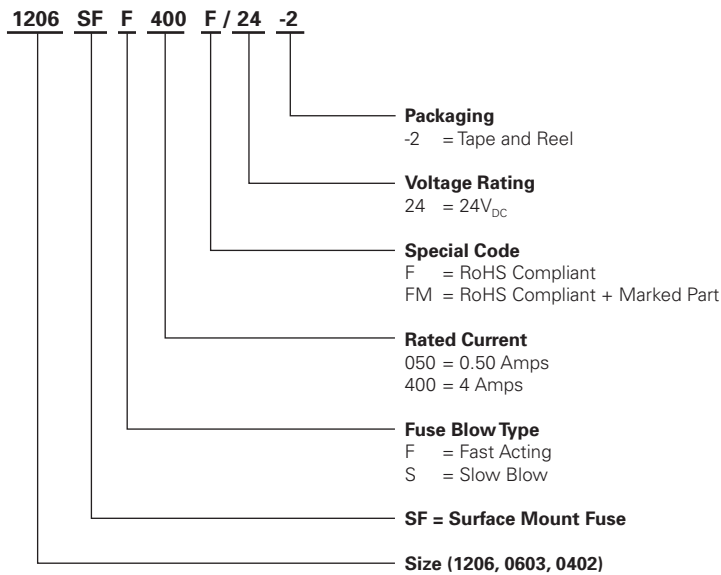


Agency Approvals for All Fuses

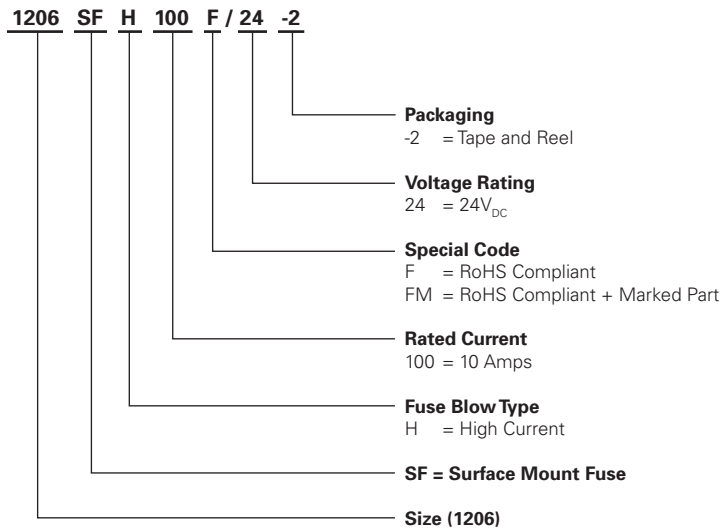
UL

File # E197536

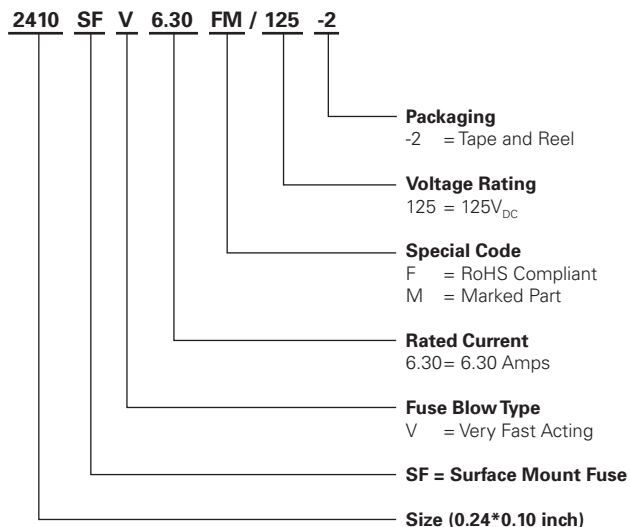
Part Numbering System for Fast-Acting, Slow-Blow And 0603 Very Fast-Acting Chip Fuses



Part Numbering System for High-Current-Rated Chip Fuses



11

Part Numbering System for 2410 Very Fast-Acting Fuses

Warning :

All information, including illustrations, is believed to be accurate and reliable. Users, however, should independently evaluate the suitability of and test each product selected for their application. Tyco Electronics Corporation and/or its Affiliates in the TE Connectivity Ltd. family of companies ("TE") makes no warranties as to the accuracy or completeness of the information, and disclaims any liability regarding its use. TE's only obligations are those in the TE Standard Terms and Conditions of Sale for this product, and in no case will TE be liable for any incidental, indirect, or consequential damages arising from the sale, resale, use, or misuse of the product. Specifications are subject to change without notice. In addition, TE reserves the right to make changes to materials or processing that do not affect compliance with any applicable specification without notification to Buyer.

