

## RACON 12 S, SMT, 6,8<sup>±1,6</sup> N, 1 NO

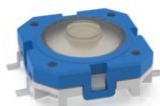

### fields of application

- › Measurement-control-regulation
- › Mechanical and system engineering
- › Automotive
- › Electro-medical

### special features

- Gold contacts, reliable switching with low currents
- Special tactile feedback
- Different operating forces
- Variable overall heights due to plunger
- Terminal technology: SMT or THT
- Traceability through product identification sealable (tested media see Downloads)



### description

Our top-quality RACON 12 tactile switches – in the dimensions 12 x 12 mm – feature an unmistakable click, high switching reliability, a sealed contact system and castability. That has made RACON the standard in many industries. Whether for automotive applications, systems with keycaps, or membrane keyboards, RACON impresses in the THT or SMT versions – for your application too.

RACON 12 tactile switches can be arranged individually, in rows or as key blocks. When used beneath membrane overlays, the RACON key switches should be combined with plungers. Suitable for the most important soldering techniques

Soldering bath for THT versions

Reflow soldering for SMT versions

Vapor phase soldering for SMT versions

Manual soldering

Processing of the SMT designs with SMT automatic assembly machines

IMDS entry

### technical data

#### › general

Color	blue
Operating temperature, min.	-40 °C
Storage temperature, min.	-50 °C
Operating temperature, max.	90 °C
Storage temperature, max.	90 °C
illuminated	No
Soldering	Reflow
Solder heat resistance according to standard	DIN EN 60068-2-58

#### direct links

- › RAFI eCatalog

Packaging	Blister
Packaging unit	750 pcs.
Operating life	1,000,000 cycles
B10	1,300,000 cycles
Degree of protection, front side, according to DIN EN 60529	IP54 IPx7
Degree of protection, rear side, according to DIN EN 60529	IP54 IPx7
Corrosive gas testing according to standard	Yes
MOQ order	750 pcs.
RoHS compliant	Yes
REACH compliant	Yes
Component material	Elastomer
<b>&gt; mounting diameters</b>	
Installation height	4.95 $\pm$ 0.1 mm
Grid, min.	12,5 x 15,24 mm
Outside dimension, length	12 mm
Outside dimension, width	12 mm
Outside dimension, height	4.95 $\pm$ 0.1 mm
<b>&gt; mechanical data</b>	
Actuation function	momentary contact function
Operating force, max.	10 N
Operating force, min.	6,8 $\pm$ 1,6 N
Switching travel	0,7 $\pm$ 0,1 mm
Contact function	1 NO
Contact system	Snap-action contact
Contact material	Gold
Terminal on the rear	SMT
Solderability	Yes
<b>&gt; electrical data</b>	
Rated voltage, min.	0.02 V
Rated voltage, max.	35 V
Rated current, min.	0.00001 A
Rated current, max.	0.1 A
Rated power, max.	1 W

**drawings**

**Dimensioned drawing**

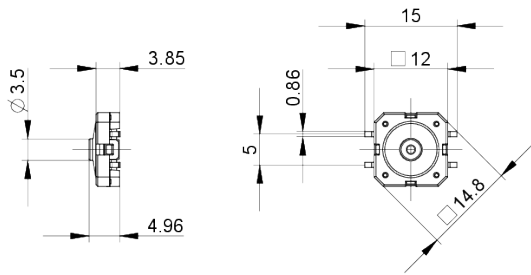

**System drawing**

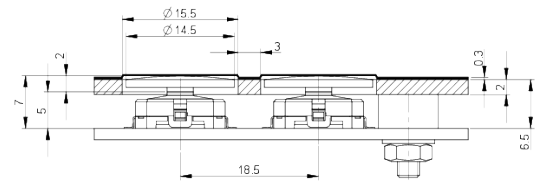

**System drawing**

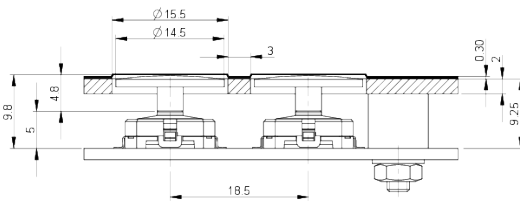

**System drawing**

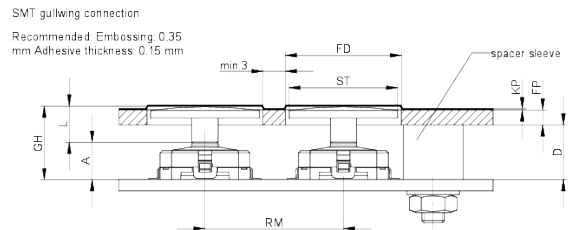

**PCB drawing**

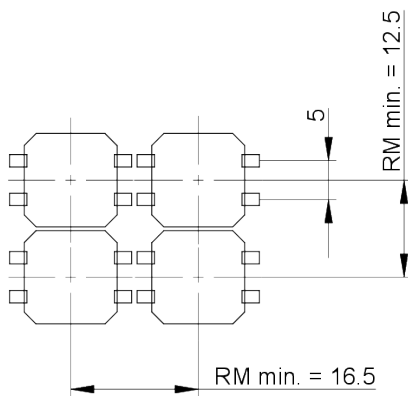

**PCB drawing**

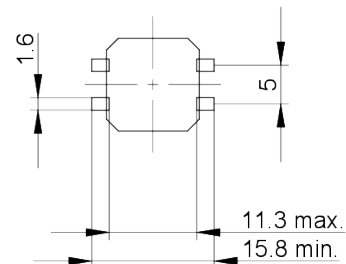

PCB-Pad  
component side

**Product labeling drawing**

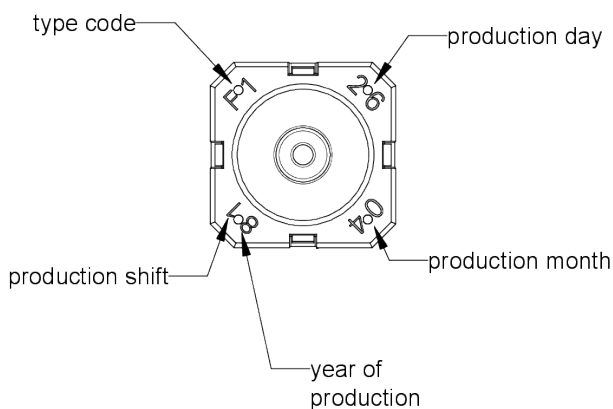

**Packaging drawing**

