

High capacity DC cut-off Relays
HE-V RELAYS

Product Catalog

**IN Your
Future**

HE-V RELAYS

Max. 1,000 V DC, 20 A cut-off possible, High capacity DC power relays

Protective construction : Flux-resistant type

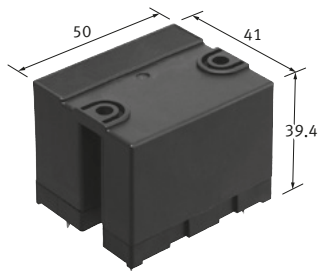

(Unit : mm)

FEATURES

- Max. 1,000 V DC, 20 A cut-off has been achieved (at contact connected in series)
- Contact arrangement: 2 Form A
400 V DC, 20 A per 1 Form A
- Compact size

TYPICAL APPLICATIONS

- Photovoltaic power generation systems
- Battery charge and discharge systems
- Inverter control, DC load control, etc.

DETAILS FEATURES

- Compact size (W: 41 × L: 50 × H: 39.4 mm)
Max. 1,000 V DC, 20 A cut-off has been achieved (at contact connected in series)

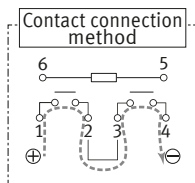

- Contributes to energy saving in devices thanks to reduced coil holding voltage
Coil holding voltage can be reduced down to 33 % of the rated coil voltage. This equals to operating power of approximately 210 mW.

* Coil holding voltage: coil voltage after 100 ms following application of the rated coil voltage

ORDERING INFORMATION (PART NO. : Ordering part number for Japanese market)

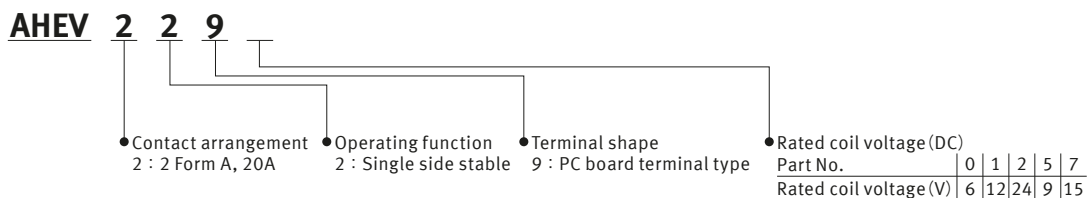

ORDERING INFORMATION (TYPE NO. : Ordering part number for non Japanese market)

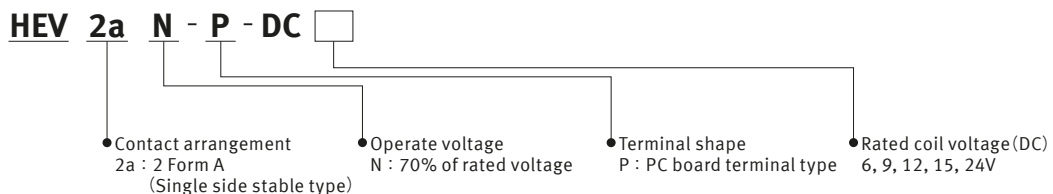

High capacity DC cut-off Relays HE-V RELAYS

TYPES

" Type No. " is ordering part number for non Japanese market. " Part No. " is ordering part number for Japanese market.

Contact arrangement	Rated coil voltage	Type No.	Part No.	Standard packing	
				Inner carton	Outer carton
2 Form A	6 V DC	HEV2aN-P-DC6V	AHEV2290	10 pcs.	50 pcs.
	9 V DC	HEV2aN-P-DC9V	AHEV2295		
	12 V DC	HEV2aN-P-DC12V	AHEV2291		
	15 V DC	HEV2aN-P-DC15V	AHEV2297		
	24 V DC	HEV2aN-P-DC24V	AHEV2292		

RATING

Coil data

- Operating characteristics such as " Operate voltage " and " Release voltage " are influenced by mounting conditions or ambient temperature, etc.
Therefore, please use the relay within $\pm 5\%$ of rated coil voltage.
- " Initial " means the condition of products at the time of delivery.

Rated coil voltage	Operate voltage* (at 20 °C)	Release voltage* (at 20 °C)	Rated operating current ($\pm 10\%$, at 20 °C)	Coil resistance ($\pm 10\%$, at 20 °C)	Rated operating power	Max. allowable voltage (at 55 °C)
6 V DC	Max. 70 % V of rated coil voltage (Initial)	Min. 5 % V of rated coil voltage (Initial)	320 mA	18.8 Ω	1,920 mW	110 % V of rated coil voltage
9 V DC			213 mA	42.2 Ω		
12 V DC			160 mA	75 Ω		
15 V DC			128 mA	117 Ω		
24 V DC			80 mA	300 Ω		

* Square, pulse drive

Specifications

Item	Specifications	
Contact arrangement	2 Form A	
Contact resistance (initial)	Max. 100 m Ω (by voltage drop 6 V DC 1 A) Max. 3 m Ω (by voltage drop 6 V DC 20 A, reference value)	
Contact material	AgNi type	
Contact rating (resistive)	20 A 800 V DC, 25 A 600 V DC (at contact connected in series) 20 A 400 V DC (at 1 Form A contact only)	
Max. switching voltage	1,000 V DC	
Max. switching current	25 A	
Min. switching load (reference value) *1	100 mA 5 V DC	
Insulation resistance (initial)	Min. 1,000 M Ω (at 1,000 V DC, Measured portion is the same as the case of dielectric strength.)	
Short current (initial)	Max. 300 A 1 ms (reference value)	
Dielectric strength (initial)	Between open contacts	2,000 V rms for 1 min (detection current: 10 mA)
	Between contact sets	4,000 V rms for 1 min (detection current: 10 mA)
	Between contact and coil	5,000 V rms for 1 min (detection current: 10 mA)
Surge withstand voltage (initial) *2	Between contact and coil 10,000 V	
Coil holding voltage*3	33 to 110 % V (at -40 to +55 °C: contact carrying current 25 A) 33 to 60 % V (at -40 to +85 °C: contact carrying current 25 A)	
Time characteristic (initial)	Operate time	Max. 30 ms at rated coil voltage (at 20 °C, without bounce)
	Release time	Max. 10 ms at rated coil voltage (at 20 °C, without bounce, without diode)
Shock resistance	Functional	98 m/s ² (half-sine shock pulse: 11 ms, detection time: 10 μ s)
	Destructive	980 m/s ² (half-sine shock pulse: 6 ms)
Vibration resistance	Functional	10 to 55 Hz (at double amplitude of 1 mm, detection time: 10 μ s)
	Destructive	10 to 55 Hz (at double amplitude of 1.5 mm)
Expected life	Mechanical life Min. 10 ⁶ ope. (switching frequency: at 180 times/min)	
Conditions	Conditions for usage, transport and storage*4 Ambient temperature: -40 to +55 °C (when coil holding voltage is 33 % to 110 % of rated coil voltage) -40 to +85 °C (when coil holding voltage is 33 % to 60 % of rated coil voltage) Humidity: 5 to 85 % RH (Avoid icing and condensation)	
Unit weight	Approx. 120 g	

*1: This value can change due to the switching frequency, environmental conditions, and desired reliability level, therefore it is recommended to check this with the actual load.

*2: Wave is standard shock voltage of $\pm 1.2 \times 50 \mu$ s according to JEC-212-1981

*3: Coil holding voltage is the coil voltage after 100 ms from the applied rated coil voltage.

*4: For ambient temperature, please read " GUIDELINES FOR RELAY USAGE ".

High capacity DC cut-off Relays HE-V RELAYS

Expected electrical life

● Contact connected in series

Conditions: at 20 °C (L/R ≤ 1 ms), switching frequency ON : OFF = 1 s : 9 s

Load	Switching capacity	Number of operations
Resistive load	20 A 600 V DC	Min. 10 × 10 ³ ope.
	20 A 800 V DC	Min. 10 ³ ope.
	25 A 600 V DC	Min. 6 × 10 ³ ope.
Overload	20 A 1,000 V DC	Min. 10 ope.
Reverse direction	-20 A 400 V DC	Min. 10 ³ ope.
Inrush resistance current	40 A 800 V DC	Min. 10 ³ ope.

● 1 Form A contact only

Conditions: at 20 °C (L/R ≤ 1 ms), switching frequency ON : OFF = 1 s : 9 s

Load	Switching capacity	Number of operations
Resistive load	20 A 300 V DC	Min. 10 × 10 ³ ope.
	20 A 400 V DC	Min. 10 ³ ope.
Overload	20 A 500 V DC	Min. 10 ope.
Reverse direction	-20 A 200 V DC	Min. 10 ³ ope.
Inrush resistance current	40 A 400 V DC	Min. 10 ³ ope.

● Recommended circuit

Positive polarity of load should be connected to pin 1 and pin 3, refer to the following circuit schematics.

Contact connected in series (BOTTOM VIEW)

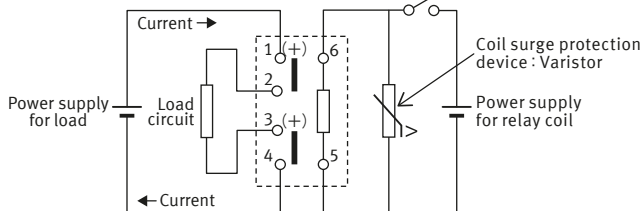

1 Form A contact only (BOTTOM VIEW)

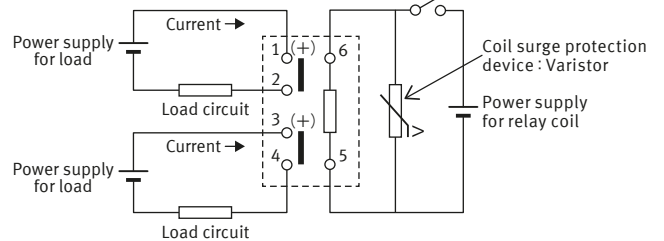

REFERENCE DATA

1. Max. switching capacity

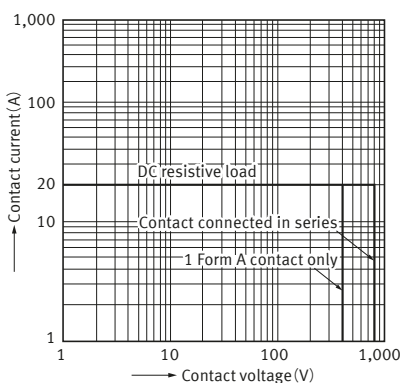

2-1. Switching and cut-off life curve (Forward direction)

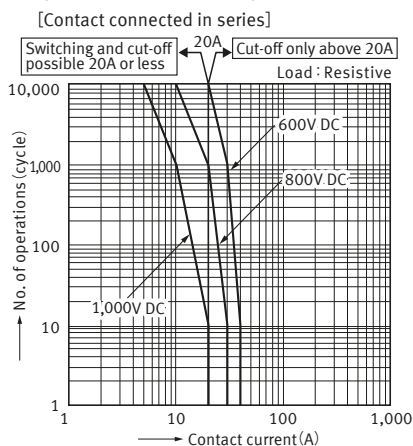

2-2. Switching and cut-off life curve (Forward direction)

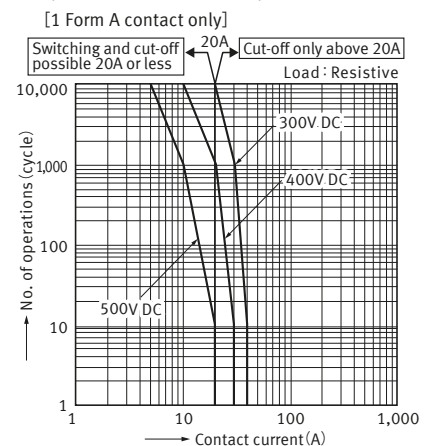

High capacity DC cut-off Relays HE-V RELAYS

3. Coil temperature characteristics

Measured portion : Coil inside
 Contact current : 20A
 Ambient temperature : 25°C, 55°C, 85°C

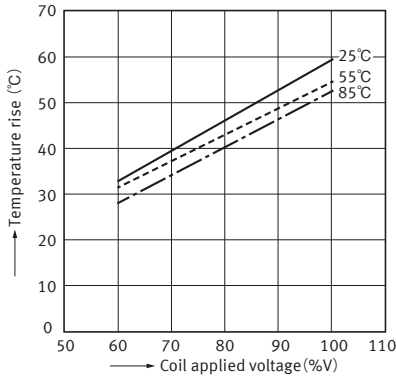

4. Ambient temperature characteristics (Average)

Tested sample : HEV2aN-P-12V DC, 6 pcs.

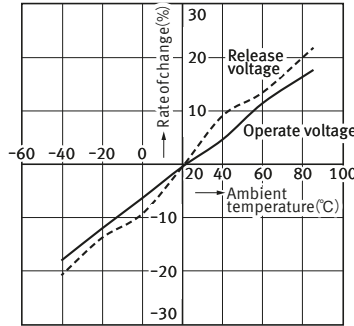

DIMENSIONS (Unit: mm)

CAD The CAD data of the products with a " CAD " mark can be downloaded from our Website.

CAD



External dimensions

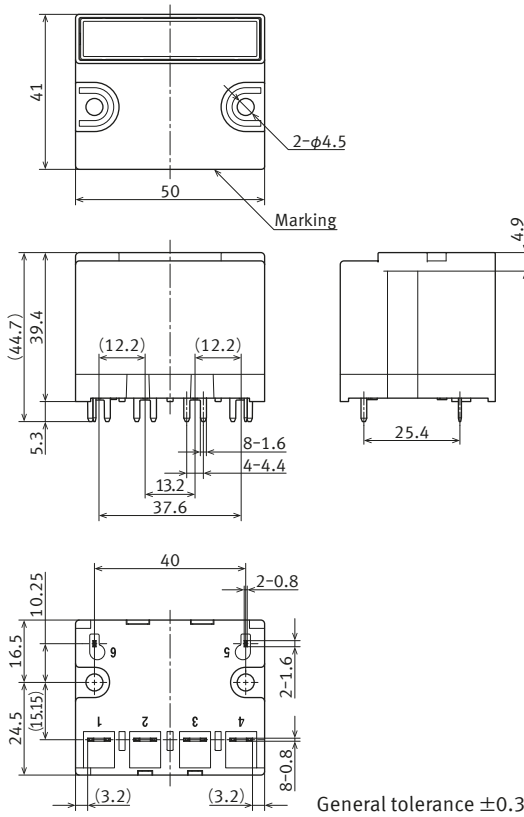

Recommended PC board pattern (BOTTOM VIEW)

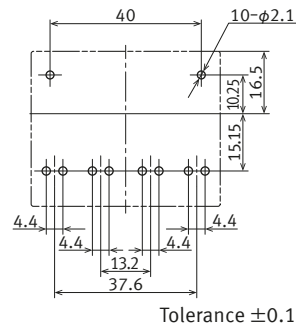

Schematic (BOTTOM VIEW)

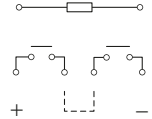

SAFETY STANDARDS

Each standard may be updated at any time, so please check our Website for the latest information.

UL/C-UL (Approved)

File No.	Contact rating	Operations	Ambient temperature
E43028	25 A 600 V DC Same polarity only	6 × 10 ³	85 °C
	20 A 600 V DC Same polarity only	10 × 10 ³	85 °C

CSA (Approved)

CSA standard approved by C-UL

VDE (Approved)

File No.	Contact rating	Operations	Ambient temperature
40006681	20 A 1,000 V DC	10	85 °C
	20 A 800 V DC	10 ³	85 °C
	20 A 600 V DC	10 × 10 ³	85 °C

High capacity DC cut-off Relays HE-V RELAYS

GUIDELINES FOR USAGE

■ For cautions for use, please read " GUIDELINES FOR RELAY USAGE ".
https://industrial.panasonic.com/ac/e/control/relay/cautions_use/index.jsp

■ Cautions for usage of HE-V relay

● Usage, transport and storage conditions

- 1) Temperature
 - 40 to +55 °C (When coil holding voltage is 33 to 110 % V)
 - 40 to +85 °C (When coil holding voltage is 33 to 60 % V)
- 2) Humidity
 - 5 to 85 % RH (Avoid icing and condensation)
 - Note) The humidity range varies with the temperature. Use within the range indicated in the graph.
- 3) Atmospheric pressure
 - 86 to 106 kPa
- 4) Condensation
 - Condensation forms when there is a sudden change in temperature under high temperature and high humidity conditions. Condensation will cause deterioration of the relay insulation.
- 5) Freezing
 - Condensation or other moisture may freeze on the relay when the temperatures is lower than 0 °C. This causes problems such as sticking of movable parts or operational time lags.
- 6) Low temperature and low humidity environments
 - The plastic becomes brittle if the relay is exposed to a low temperature, low humidity environment for long periods of time.

[Temperature and humidity range for usage, transport, and storage]
 [Coil holding voltage 33 to 110 % V]

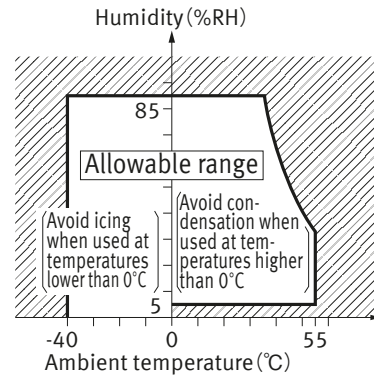

[Coil holding voltage 33 to 60 % V]

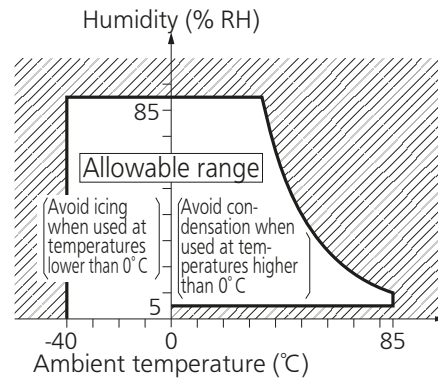

● Solder and cleaning conditions

Please obey the following conditions.

1) Automatic soldering

(1) Preheating

Temperature	Max. 120 °C (solder surface terminal portion)
Time	Within 120 seconds

(2) Soldering

Soldering temperature	260 ±5 °C
Soldering time	Within 10 seconds

2) Manual soldering

Soldering temperature	Max. 260 °C	Max. 350 °C
Soldering time	Within 10 seconds	Within 3 seconds

Note) Effects of soldering heat on the relays vary depending on the PC board. So please confirm actual soldering condition with the PC board used for assembling.

- 3) Since this is not a sealed type relay, do not clean it as is. Also, be careful not to allow flux to overflow above the PC board or enter the inside of the relay.

● Cautions for usage

- For precautions regarding use and explanations of technical terminology, please refer to our web site.
- To ensure good operation, please keep the voltage on the coil ends to ±5 % (at 20 °C) of the rated coil voltage. Also, please be aware that the operate voltage and release voltage may change depending on the temperature and conditions of use.

- Keep the ripple rate of the rated coil voltage below 5 %. Please use a varistor to absorb coil surges. Please note that if a diode is used, contact opening velocity will become slower and sufficient cutoff performance cannot be guaranteed.

Recommended Varistor

Maximum energy	Min. 1J
Varistor voltage	150 to 400 % of rated coil voltage

High capacity DC cut-off Relays HE-V RELAYS

- The expected life is defined under the standard test condition specified in the JIS C 5442 standard (temperature 15 to 35 °C, humidity 25 to 75 % RH) . Check this with the real device as it is affected by coil driving circuit, load type, activation frequency, ambient conditions and other factors. Especially, contact terminals have polarity. So if the contact terminals were connected with opposite pole, the expected life would be shorter.
- This value can change due to the switching frequency, environmental conditions, and desired reliability level, therefore it is recommended to check this with the actual load.
- Heat, smoke, and even a fire may occur if the relay is used in conditions outside of the allowable ranges for the coil ratings, contact ratings, expected life, and other specifications. Therefore, do not use the relay if these ratings are exceeded.
- If a relay is dropped, please do not use it.
- Incorrect wiring may cause unexpected events or the generation of heat or flames.
- The relay should not be installed near strong magnetic field (transformers, magnets, etc.) and should not be installed near objects that radiate heat.
- If several relays are mounted close together, please be careful of the abnormal heating by mutual heat interference and the insulation distance between the terminals outside of the relays.
- If you are using an inductive load (L load) such that $L/R > 1$ ms, add surge protection in parallel with the inductive load. If this is not done, the electrical life will decrease and cut-off failure may occur.
- In case using a capacitive load (C load) , please take a countermeasure as pre-charging to the capacitive load so that the inrush current will not surpass 40 A. The relay might have a contact welding without such countermeasure.
- This relay is a high-voltage direct-current switch. In its final breakdown mode, it may lose the ability to provide the proper cut-off. Therefore, do not exceed the indicated switching capacity and life. (Please treat the relay as a product with limited life and replace it when necessary.)
In the event that the relay loses cut-off ability, there is a possibility that burning may spread to surrounding parts, so configure the layout so that the power is turned off within one second and from the point of view of safety, consider installing a failsafe circuit in the device.
- Please carry out the design which had a enough margin in conductor width and a space between conductors in the case of a design of a PC board.
- Take note that contact terminals have polarity. If they are used for power distribution only, there is no polarity.

- For cautions for use, please read " GUIDELINES FOR RELAY USAGE ".
https://industrial.panasonic.com/ac/e/control/relay/cautions_use/index.jsp

Precautions for Coil Input

■ Long term current carrying

A circuit that will be carrying a current continuously for long periods without relay switching operation. (circuits for emergency lamps, alarm devices and error inspection that, for example, revert only during malfunction and output warnings with form B contacts) Continuous, long-term current to the coil will facilitate deterioration of coil insulation and characteristics due to heating of the coil itself. For circuits such as these, please use a magnetic-hold type latching relay. If you need to use a single stable relay, use a sealed type relay that is not easily affected by ambient conditions and make a failsafe circuit design that considers the possibility of contact failure or disconnection.

■ DC Coil operating power

Steady state DC current should be applied to the coil. The wave form should be rectangular. If it includes ripple, the ripple factor should be less than 5 %. However, please check with the actual circuit since the electrical characteristics may vary. The rated coil voltage should be applied to the coil and the set/reset pulse time of latching type relay differs for each relays, please refer to the relay's individual specifications.

■ Coil connection

When connecting coils of polarized relays, please check coil polarity (+ , -) at the internal connection diagram (Schematic). If any wrong connection is made, it may cause unexpected malfunction, like abnormal heat, fire and so on, and circuit do not work. Avoid impressing voltages to the set coil and reset coil at the same time.

■ Maximum allowable voltage and temperature rise

Proper usage requires that the rated coil voltage be impressed on the coil. Note, however, that if a voltage greater than or equal to the maximum continuous voltage is impressed on the coil, the coil may burn or its layers short due to the temperature rise. Furthermore, do not exceed the usable ambient temperature range listed in the catalog.

● Operate voltage change due to coil temperature rise

In DC relays, after continuous passage of current in the coil, if the current is turned OFF, then immediately turned ON again, due to the temperature rise in the coil, the operate voltage will become somewhat higher. Also, it will be the same as using it in a higher temperature atmosphere. The resistance/temperature relationship for copper wire is about 0.4 % for 1 °C, and with this ratio the coil resistance increases. That is, in order to operate of the relay, it is necessary that the voltage be higher than the operate voltage and the operate voltage rises in accordance with the increase in the resistance value. However, for some polarized relays, this rate of change is considerably smaller.

Ambient Environment

Usage, Transport, and Storage Conditions

During usage, storage, or transportation, avoid locations subjected to direct sunlight and maintain normal temperature, humidity and pressure conditions.

Temperature/Humidity/Pressure

When transporting or storing relays while they are tube packaged, there are cases the temperature may differ from the allowable range. In this case be sure to check the individual specifications.

Also allowable humidity level is influenced by temperature, please check charts shown below and use relays within mentioned conditions. (Allowable temperature values differ for each relays, please refer to the relay's individual specifications.)

1) Temperature:

The tolerance temperature range differs for each relays, please refer to the relay's individual specifications

2) Humidity: 5 to 85 % RH

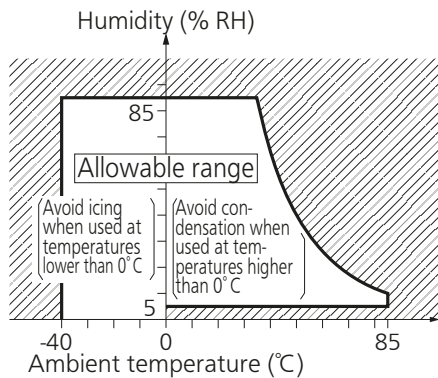

3) Pressure: 86 to 106 kPa

Dew condensation

Condensation occurs when the ambient temperature drops suddenly from a high temperature and humidity, or the relay is suddenly transferred from a low ambient temperature to a high temperature and humidity.

Condensation causes the failures like insulation deterioration, wire disconnection and rust etc.

Panasonic Industry Co., Ltd. does not guarantee the failures caused by condensation.

The heat conduction by the equipment may accelerate the cooling of device itself, and the condensation may occur.

Please conduct product evaluations in the worst condition of the actual usage. (Special attention should be paid when high temperature heating parts are close to the device. Also please consider the condensation may occur inside of the device.)

Icing

Condensation or other moisture may freeze on relays when the temperature become lower than 0 °C. This icing causes the sticking of movable portion, the operation delay and the contact conduction failure etc. Panasonic Industry Co., Ltd. does not guarantee the failures caused by the icing.

The heat conduction by the equipment may accelerate the cooling of relay itself and the icing may occur. Please conduct product evaluations in the worst condition of the actual usage.

Low temperature and low humidity

The plastic becomes brittle if the relay is exposed to a low temperature, low humidity environment for long periods of time.

High temperature and high humidity

Storage for extended periods of time (including transportation periods) at high temperature or high humidity levels or in atmospheres with organic gases or sulfide gases may cause a sulfide film or oxide film to form on the surfaces of the contacts and/or it may interfere with the functions. Check out the atmosphere in which the units are to be stored and transported.

Package

In terms of the packing format used, make every effort to keep the effects of moisture, organic gases and sulfide gases to the absolute minimum.

Silicon

When a source of silicone substances (silicone rubber, silicone oil, silicone coating materials and silicone filling materials etc.) is used around the relay, the silicone gas (low molecular siloxane etc.) may be produced.

This silicone gas may penetrate into the inside of the relay. When the relay is kept and used in this condition, silicone compound may adhere to the relay contacts which may cause the contact failure. Do not use any sources of silicone gas around the relay (Including plastic sealed types).

NOx Generation

When relay is used in an atmosphere high in humidity to switch a load which easily produces an arc, the NOx created by the arc and the water absorbed from outside the relay combine to produce nitric acid.

This corrodes the internal metal parts and adversely affects operation.

Avoid use at an ambient humidity of 85 % RH or higher (at 20 °C). If use at high humidity is unavoidable, please contact our sales representative.

Others

■ Cleaning

- Although the environmentally sealed type relay (plastic sealed type, etc.) can be cleaned, avoid immersing the relay into cold liquid (such as cleaning solvent) immediately after soldering. Doing so may deteriorate the sealing performance.
- Cleaning with the boiling method is recommended (The temperature of cleaning liquid should be 40 °C or lower). Avoid ultrasonic cleaning on relays. Use of ultrasonic cleaning may cause breaks in the coil or slight sticking of the contacts due to ultrasonic energy.

Please refer to "**the latest product specifications**" when designing your product.

- Requests to customers:

<https://industrial.panasonic.com/ac/e/salespolicies/>

■ Global Sales Network Information: industrial.panasonic.com/ac/e/salesnetwork

Panasonic
INDUSTRY

Panasonic Industry Co., Ltd.

Electromechanical Control Business Division

■ 1006, Oaza Kadoma, Kadoma-shi, Osaka 571-8506, Japan
industrial.panasonic.com/ac/e/