

Automotive Relays  
**TB RELAYS**

Product Catalog

**IN Your  
Future**

**TB** RELAYS**Miniature PC Board, Twin/1 Form C Type Automotive Relay**

◁ Protective construction ▷

Standard type/High heat-resistant type: Sealed

Pin in Paste compliant type: Flux tight

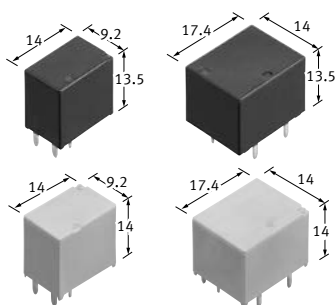

(Unit: mm)

**FEATURES**

- Compact and high-capacity 25 A load switching
- Wide line-up
- Pin in Paste compliant model added.

**TYPICAL APPLICATIONS**

- Powered windows, Automatic door locks, Powered mirrors, Powered sunroof, Powered seats, Lift gates and Slide door closers, etc.

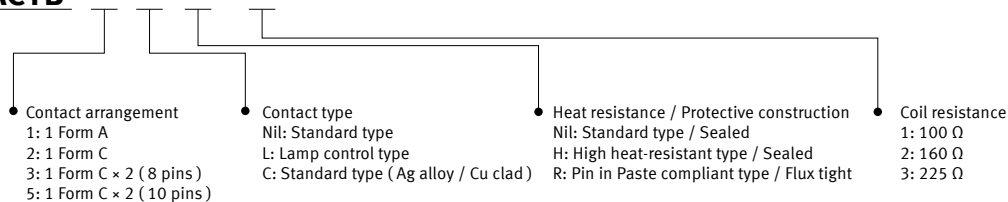
**ORDERING INFORMATION (PART NO.)****ACTB**

# Automotive Relays TB RELAYS

## TYPES

Contact arrangement	Contact type	Coil resistance	Part No.			Packing	
			Heat resistance			Carton (1-tube)	Case
			Standard type	High heat-resistant type	Pin in Paste compliant type		
1 Form A	Standard type	100 Ω	ACTB11	ACTB1H1	ACTB1R1	50 pcs.	2,000 pcs.
		160 Ω	ACTB12	ACTB1H2	ACTB1R2		
		225 Ω	ACTB13	ACTB1H3	ACTB1R3		
	Standard type (Ag alloy / Cu clad)	100 Ω	ACTB1C1	ACTB1CH1	ACTB1CR1		
		160 Ω	ACTB1C2	ACTB1CH2	ACTB1CR2		
		225 Ω	ACTB1C3	ACTB1CH3	ACTB1CR3		
	Lamp control type	100 Ω	ACTB1L1	ACTB1LH1	ACTB1LR1		
		160 Ω	ACTB1L2	ACTB1LH2	ACTB1LR2		
		225 Ω	ACTB1L3	ACTB1LH3	ACTB1LR3		
1 Form C	Standard type	100 Ω	ACTB21	ACTB2H1	ACTB2R1	50 pcs.	2,000 pcs.
		160 Ω	ACTB22	ACTB2H2	ACTB2R2		
		225 Ω	ACTB23	ACTB2H3	ACTB2R3		
	Standard type (Ag alloy / Cu clad)	100 Ω	ACTB2C1	ACTB2CH1	ACTB2CR1		
		160 Ω	ACTB2C2	ACTB2CH2	ACTB2CR2*1		
		225 Ω	ACTB2C3	ACTB2CH3	ACTB2CR3		
	Lamp control type	100 Ω	ACTB2L1	ACTB2LH1	ACTB2LR1		
		160 Ω	ACTB2L2	ACTB2LH2	ACTB2LR2		
		225 Ω	ACTB2L3	ACTB2LH3	ACTB2LR3		
1 Form C x 2 (8 pins)	Standard type	100 Ω	ACTB31	ACTB3H1	ACTB3R1	25 pcs.	1,000 pcs.
		160 Ω	ACTB32	ACTB3H2	ACTB3R2		
		225 Ω	ACTB33	ACTB3H3	ACTB3R3		
	Standard type (Ag alloy / Cu clad)	100 Ω	ACTB3C1	ACTB3CH1	ACTB3CR1		
		160 Ω	ACTB3C2*2	ACTB3CH2	ACTB3CR2		
		225 Ω	ACTB3C3	ACTB3CH3	ACTB3CR3		
1 Form C x 2 (10 pins)	Standard type	100 Ω	ACTB51	ACTB5H1	ACTB5R1	25 pcs.	1,000 pcs.
		160 Ω	ACTB52	ACTB5H2	ACTB5R2		
		225 Ω	ACTB53	ACTB5H3	ACTB5R3		
	Standard type (Ag alloy / Cu clad)	100 Ω	ACTB5C1	ACTB5CH1	ACTB5CR1		
		160 Ω	ACTB5C2	ACTB5CH2	ACTB5CR2		
		225 Ω	ACTB5C3	ACTB5CH3	ACTB5CR3		
	Lamp control type	100 Ω	ACTB5L1	ACTB5LH1	ACTB5LR1		
		160 Ω	ACTB5L2	ACTB5LH2	ACTB5LR2		
		225 Ω	ACTB5L3	ACTB5LH3	ACTB5LR3		

\*1: Please order "ACTB2CR2A60" (standard stock part number).

\*2: Please order "ACTB3C2A52" (standard stock part number).

## RATING

### Coil data

Rated coil voltage	Operate (Set) voltage (at 20°C)(Initial)	Release (Reset) voltage (at 20°C)(Initial)	Rated operating current [±10%] (at 20°C)	Coil resistance [±10%] (at 20°C)	Rated operating power (at 20°C)	Usable voltage range
12 V DC	Max. 5.5 V DC	Min. 0.5 V DC	120 mA	100 Ω	1,440 mW	10 to 16 V DC
	Max. 6.5 V DC	Min. 0.8 V DC	75 mA	160 Ω	900 mW	
	Max. 7.7 V DC		53.3 mA	225 Ω	640 mW	

Note: Other operate (set) voltage types are also available. Please inquire our sales representative for details.

Specifications

Item		Specifications
Contact data	Contact arrangement	1 Form A, 1 Form C, 1 Form C x 2
	Contact resistance (initial)	Max. 50 mΩ (N.O. side: typ. 3 mΩ, N.C. side: typ. 4 mΩ) (by voltage drop 1 A 6 V DC)
	Contact material	Ag alloy
	Rated switching capacity (resistive)	N.O. side: 20 A 14 V DC, N.C. side: 10 A 14 V DC
	Max. carrying current (initial)*1	25 A/10 min (coil applied voltage 12 V DC, at 20°C)
	Min. switching load (resistive)*2	1 A 14 V DC (at 20°C)
Insulated resistance (initial)		Min. 100 MΩ (at 500 V DC, Measurement at same location as "Dielectric strength" section.)
Dielectric strength (initial)	Between open contacts	500 Vrms for 1 min. (detection current: 10 mA)
	Between contacts and coil	500 Vrms for 1 min. (detection current: 10 mA)
Time characteristics (initial)	Operate (Set) time (at rated voltage)	Max. 10 ms (at 20°C, without contact bounce time)
	Release (Reset) time (at rated voltage)	Max. 10 ms (at 20°C, without contact bounce time) (without diode)
Shock resistance	Functional	Min. 100 m/s <sup>2</sup> (approx. 10 G) (half-wave pulse of sine wave: 11 ms, detection time: 10 μs)
	Destructive	Min. 1,000 m/s <sup>2</sup> (approx. 100 G) (half-wave pulse of sine wave: 6 ms)
Vibration resistance	Functional	10 to 100 Hz, Min. 44.1 m/s <sup>2</sup> (approx. 4.5 G) (detection time: 10 μs)
	Destructive	10 to 500 Hz, Min. 44.1 m/s <sup>2</sup> (approx. 4.5 G) Time of vibration for each direction; X, Y direction: 2 hours, Z direction: 4 hours
Expected life	Mechanical	
	Electrical	Standard type
		Lamp control type*4
Conditions		Standard type Ambient temperature: -40 to +85°C, Humidity: 5 to 85% RH High heat-resistant type/Pin in Paste compliant type Ambient temperature: -40 to +110°C, Humidity: 2 to 85% RH (Avoid icing and condensation)
Unit weight		Single type: approx. 5 g, Twin type: approx. 9.5 g

Notes: \*1. Depends on connection conditions. Also, this does not guarantee repeated switching. We recommend that you confirm operation under actual conditions.  
 \*2. This value can change due to the switching frequency, environmental conditions, and desired reliability level, therefore it is recommended to check this with the actual load.  
 \*3. The upper operation ambient temperature limit is the maximum temperature that can satisfy the coil temperature rise value. For details, please refer to the "Automotive Relay Users Guide".  
 Please inquire our sales representative if you will be using the relay in a high temperature atmosphere (110°C).  
 \*4. Part numbers for electric discharge lamp loads or any other lamp loads and for capacitor loads only consist of "ACTB\*L\*\*\*".  
 When using the lamp control type, connect N.O. to the "+" (plus) side. Please inquire our sales representative for details.

\* If the relay is used continuously for long periods of time with coils on both sides in an energized condition, breakdown might occur due to abnormal heating depending on the carrying condition. Therefore, please inquire our sales representative when using with a circuit that causes an energized condition on both sides simultaneously.

REFERENCE DATA

1.-(1)Coil temperature rise (at room temperature)

Sample: ACTB32, 3 pcs.  
 Carrying current: 0 A, 10 A, 20 A  
 Ambient temperature: Room temperature

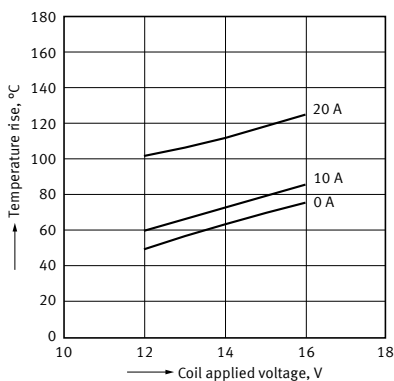

1.-(2)Coil temperature rise (at 85°C)

Sample: ACTB32, 3 pcs.  
 Carrying current: 0 A, 10 A, 20 A  
 Ambient temperature: 85°C

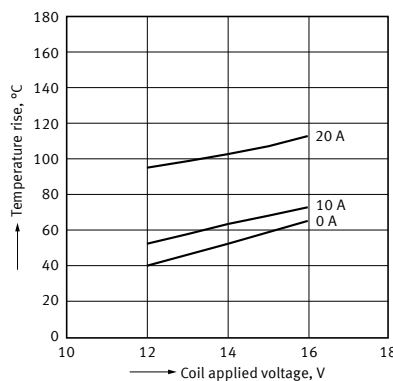

2. Ambient temperature and usable voltage range

Sample: ACTB32

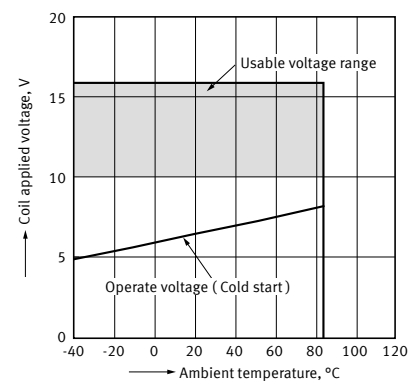

# Automotive Relays TB RELAYS

## 3. Distribution of operate (set) and release (reset) voltage

Sample: ACTB32, 40 × 2 pcs.

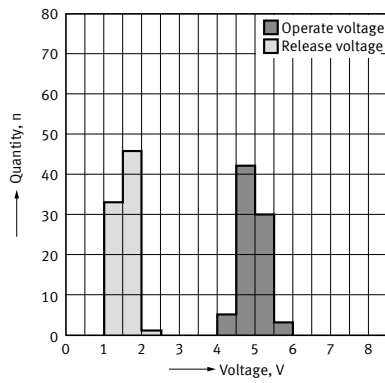

## 4. Distribution of operate (set) and release (reset) time

Sample: ACTB32, 40 × 2 pcs.

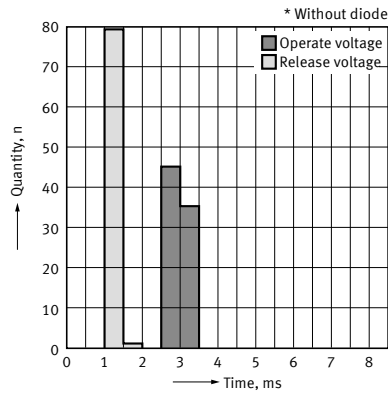

## 5. Electrical life test (Motor lock)

Sample: ACTB32, 3 pcs.  
 Load: 25 A 14 V DC  
 Power window motor actual load (lock condition)  
 Operating frequency: ON 0.5 s, OFF 9.5 s  
 Ambient temperature: Room temperature  
 Circuit:

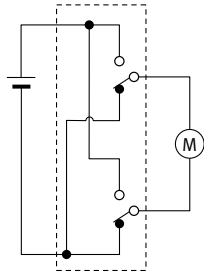

Change of operate (set) and release (reset) voltage

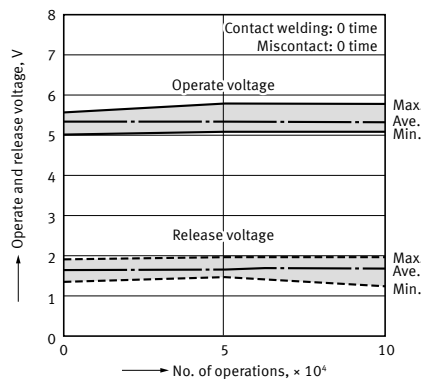

Change of contact resistance

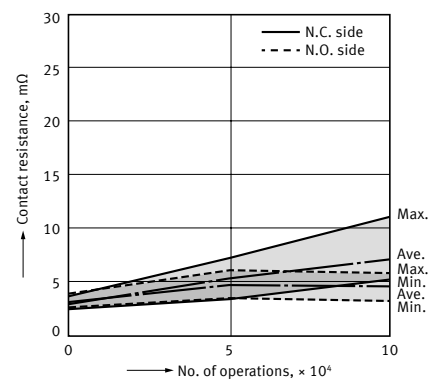

Load current waveform

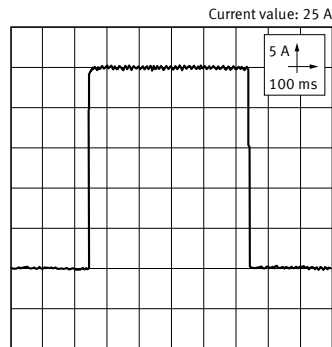

**DIMENSIONS**

**CAD** The CAD data of the products with a "CAD" mark can be downloaded from our Website.

Unit: mm

**1 Form A type**

**CAD**



External dimensions

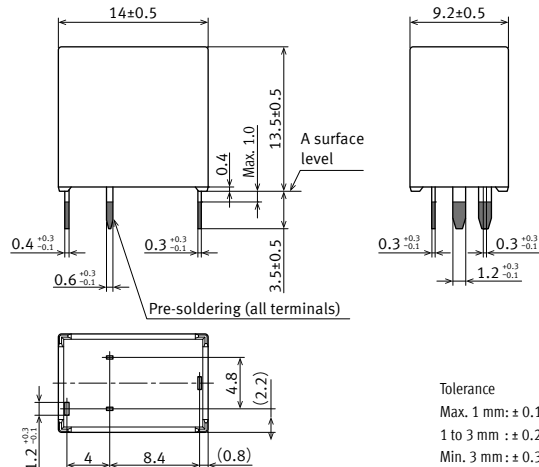

PC board pattern (BOTTOM VIEW)

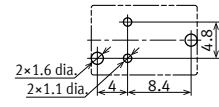

Tolerance: ± 0.1

Schematic (BOTTOM VIEW)

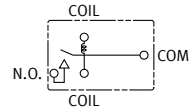

\* The lamp control type has polarized contacts. Connect N.O. to the "+" (plus)" side.

Tolerance  
Max. 1 mm: ± 0.1  
1 to 3 mm : ± 0.2  
Min. 3 mm : ± 0.3

\* Dimensions (thickness and width) of terminal is measured after pre-soldering. Intervals between terminals is measured at A surface level.

**1 Form C type**

**CAD**



External dimensions

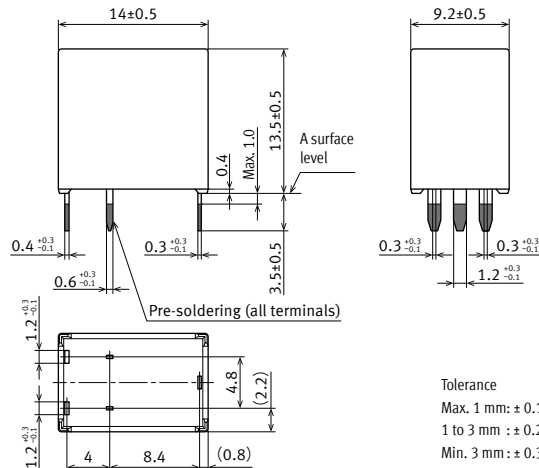

PC board pattern (BOTTOM VIEW)

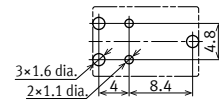

Tolerance: ± 0.1

Schematic (BOTTOM VIEW)

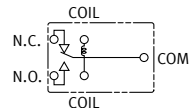

\* The lamp control type has polarized contacts. Connect N.O. to the "+" (plus)" side.

Tolerance  
Max. 1 mm: ± 0.1  
1 to 3 mm : ± 0.2  
Min. 3 mm : ± 0.3

\* Dimensions (thickness and width) of terminal is measured after pre-soldering. Intervals between terminals is measured at A surface level.

# Automotive Relays TB RELAYS

## ■ Twin type (8 pins)

CAD



### External dimensions

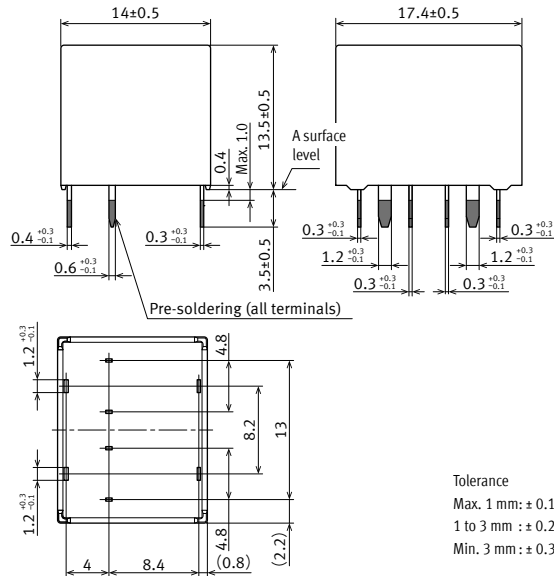

\* Dimensions (thickness and width) of terminal is measured after pre-soldering. Intervals between terminals is measured at A surface level.

### PC board pattern (BOTTOM VIEW)

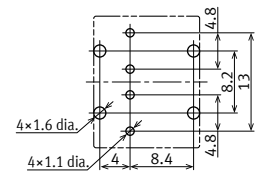

### Schematic (BOTTOM VIEW)

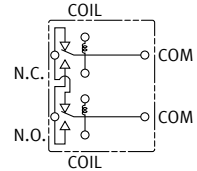

## ■ Twin type (10 pins)

CAD



### External dimensions

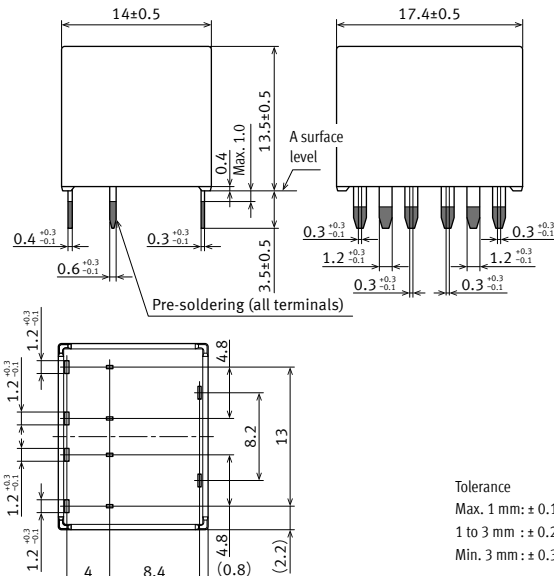

\* Dimensions (thickness and width) of terminal is measured after pre-soldering. Intervals between terminals is measured at A surface level.

### PC board pattern (BOTTOM VIEW)

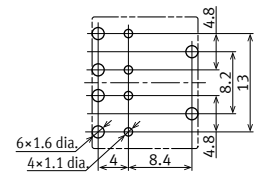

### Schematic (BOTTOM VIEW)

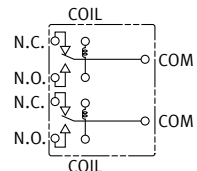

\* The lamp control type has polarized contacts. Connect N.O. to the "+" (plus)" side.

■ 1 Form A type

Pin in Paste compliant type

CAD



External dimensions

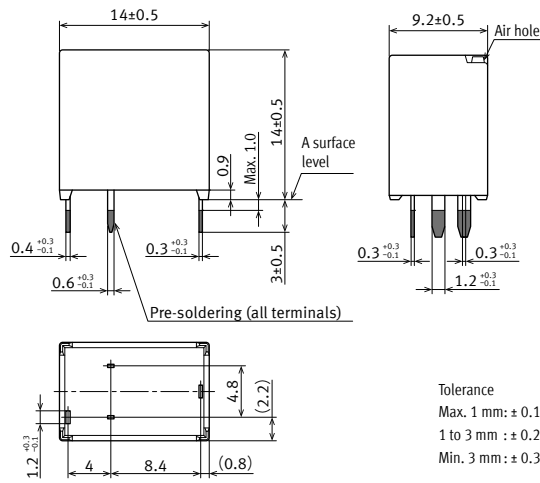

PC board pattern (BOTTOM VIEW)

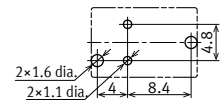

Tolerance:  $\pm 0.1$

Schematic (BOTTOM VIEW)

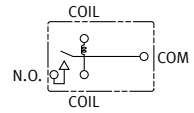

\* The lamp control type has polarized contacts. Connect N.O. to the "+ (plus)" side.

\* Dimensions (thickness and width) of terminal is measured after pre-soldering. Intervals between terminals is measured at A surface level.

■ 1 Form C type

Pin in Paste compliant type

CAD



External dimensions

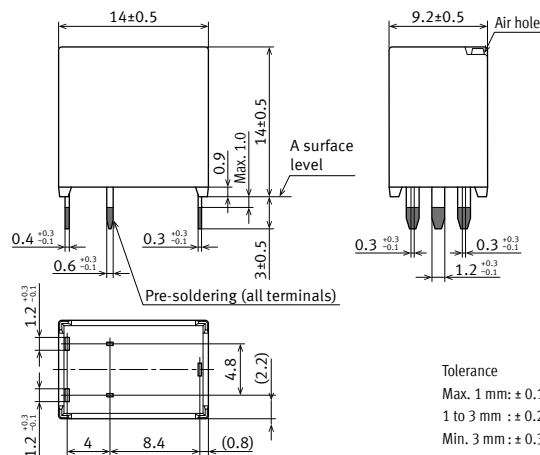

PC board pattern (BOTTOM VIEW)

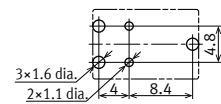

Tolerance:  $\pm 0.1$

Schematic (BOTTOM VIEW)

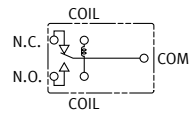

\* The lamp control type has polarized contacts. Connect N.O. to the "+ (plus)" side.

\* Dimensions (thickness and width) of terminal is measured after pre-soldering. Intervals between terminals is measured at A surface level.



# Automotive Relays TB RELAYS

## ■ Twin type (8 pins)

Pin in Paste type

CAD



External dimensions

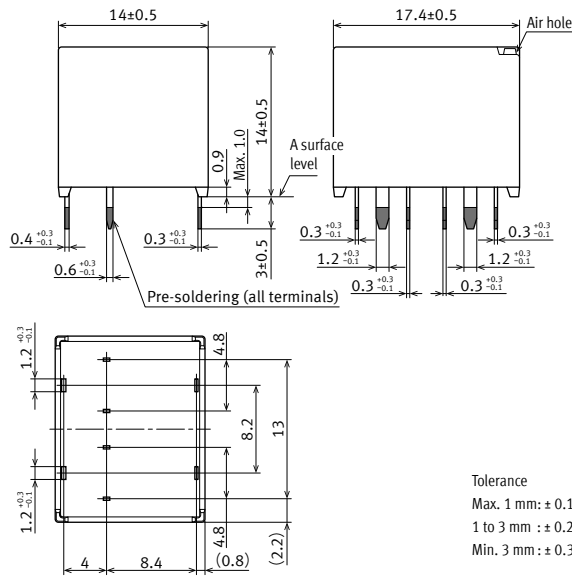

\* Dimensions (thickness and width) of terminal is measured after pre-soldering.  
 Intervals between terminals is measured at A surface level.

PC board pattern (BOTTOM VIEW)

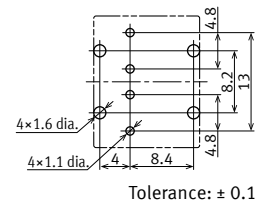

Schematic (BOTTOM VIEW)

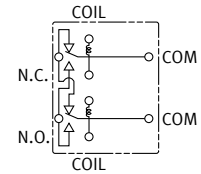

## ■ Twin type (10 pins)

Pin in Paste type

CAD



External dimensions

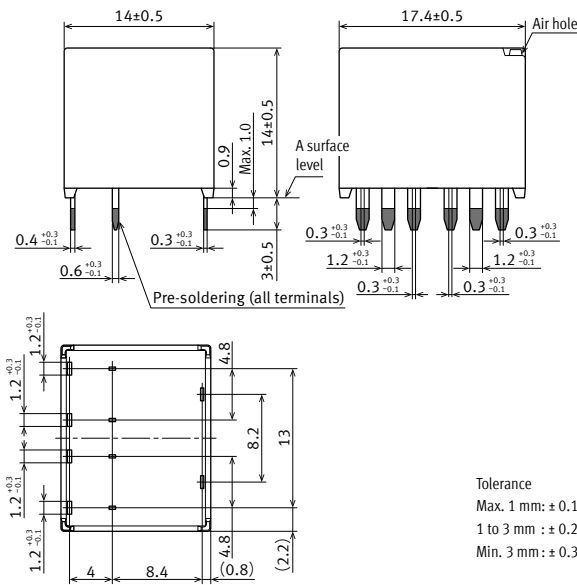

\* Dimensions (thickness and width) of terminal is measured after pre-soldering.  
 Intervals between terminals is measured at A surface level.

PC board pattern (BOTTOM VIEW)

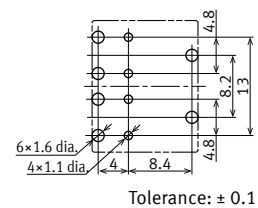

Schematic (BOTTOM VIEW)

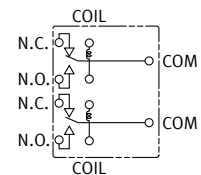

\* The lamp control type has polarized contacts.  
 Connect N.O. to the "+" (plus) side.

## GUIDELINES FOR USAGE

■ For general cautions for use, please refer to the "Automotive Relay Users Guide".

■ Usage, transport and storage conditions

1) Ambient temperature, humidity and air pressure during usage transport, and storage of the relay:

- (1) Temperature:  $-40$  to  $+85^{\circ}\text{C}$  (Standard type)  
 $-40$  to  $+110^{\circ}\text{C}$   
 (High heat-resistant type/Pin in Paste compliant type)
- (2) Humidity: 2 to 85% RH (Avoid icing and condensation)
- (3) Air pressure: 86 to 106 kPa

The humidity range varies with the temperature. Use within the range indicated in the graph below.

[Temperature and humidity range for usage, transport, and storage]

Standard type

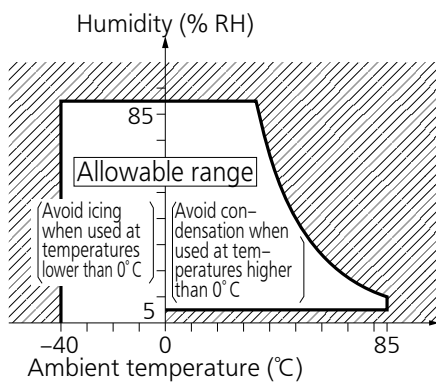

High heat resistant type

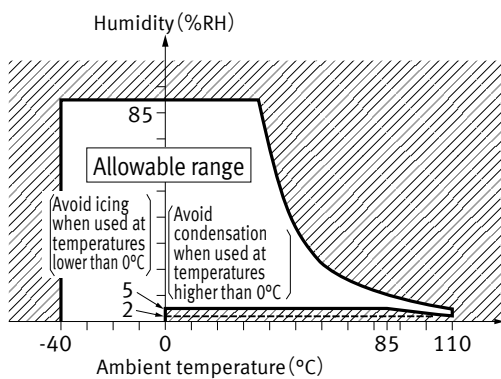

2) Water condensation

Water condensation occurs when the ambient temperature drops suddenly from a high temperature and humidity, or, the relay is suddenly transferred from a low ambient temperature to a high temperature and humidity. Condensation causes the failures like insulation deterioration, wire disconnection and rust etc. Panasonic Corporation does not guarantee the failures caused by condensation. The heat conduction by the equipment may accelerate the cooling of relay itself, and the condensation may occur. Please confirm no condensation in the worst condition of the actual usage. (Special attention should be paid when high temperature heating parts are close to the relay. Also, please consider the condensation may occur inside of the relay.)

3) Icing

Please check the icing when an ambient temperature is lower than  $0^{\circ}\text{C}$ . Icing means, the moisture contained in the surrounding environment and inside the relay freezes when the ambient temperature falls below the freezing point. The icing causes the sticking of movable portion, the operation delay and the contact conduction failure etc. Panasonic Corporation does not guarantee the failures caused by the icing. The heat conduction by the equipment may accelerate the cooling of relay itself and the icing may occur. Icing condition is changed by ambient environment, please make sure to confirm no icing in the worst condition of the actual usage.

## ■ Mounting and cleaning conditions for Pin in Paste compliant type

When soldering this relay, please observe the following conditions.

### [I.R.S method (recommended)]

(Recommended number of reflows 1 time)

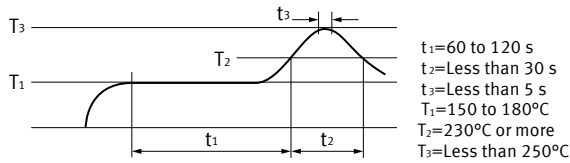

### 1) Cautions for mounting

- (1) The temperature profile shows the temperature at the soldering portion on the PC board surface.
- (2) Depending on the mounting density condition, reflow heating method, and PC board type (metal etc.), the relay's exterior and interior temperature may become extremely high. Therefore, please confirm well under the actual use condition before use.

### 2) The other cautions of reflow soldering

- (1) When soldering condition is out of recommendation, the relay performance may be adversely affected. If soldering conditions are out of our recommendation, please inquire our sales representative before operation.
- (2) Please check the effect at the actual soldering because heat stress to relay is changed by PC board type and manufacturing process condition
- (3) Solder creepage, wettability or soldering strength will be affected by the mounting condition or soldering material. Please check the actual production condition in detail.
- (4) Do not wash the relay as failures may occur.
- (5) This product is not plastic sealed type. Please perform coating with sufficient attention to avoid infiltration of the solvent to the inside. Also, please pay careful attention to use and store them with no contamination of foreign material.

Please refer to **"the latest product specifications"** when designing your product.

•Requests to customers:

<https://industrial.panasonic.com/ac/e/salespolicies/>

---

**Panasonic**  
INDUSTRY

**Panasonic Industry Co., Ltd.**

Electromechanical Control Business Division  
■1006, Oaza Kadoma, Kadoma-shi, Osaka 571-8506, Japan  
[industrial.panasonic.com/ac/e/](http://industrial.panasonic.com/ac/e/)