

LUXEON Rebel ES

*Superior efficacy  
Leading lumen output  
Ultimate design flexibility*

Technical Datasheet DS61

**LUXEON**<sup>®</sup>  
NEVER BEFORE POSSIBLE



# LUXEON<sup>®</sup> Rebel ES

Leading efficacy and light output, maximum design flexibility.

## Introduction

LUXEON<sup>®</sup> Rebel ES gives you the flexibility you need for designing luminaires and lamps. Tested and binned at 700 mA, confidently design LUXEON Rebel ES into high lumen applications or create more energy efficient devices using the same emitter. Luminaire manufacturers and designers count on LUXEON Rebel ES for quality, reliability and in-device performance.

- Broad portfolio of emitters for indoor and outdoor applications
- CCT and CRI combinations to support a wide range of applications
- Highest lumens per watt and lumens per dollar
- Lowest forward voltage
- Industry Standard ANSI color binning
- Superior >125lm/W efficacy enables efficient and sustainable applications
- Industry leading lumen maintenance
- Complete design resources available to support your application development

**PHILIPS**  
**LUMILEDS**

# Table of Contents

General Product Information .....	3
Product Nomenclature .....	3
Average Lumen Maintenance Characteristics.....	3
Environmental Compliance .....	3
Product Selection.....	4
Product Selection for LUXEON Rebel ES.....	4
Optical Characteristics.....	5
Electrical Characteristics.....	6
Absolute Maximum Ratings .....	7
JEDEC Moisture Sensitivity .....	7
Reflow Soldering Characteristics .....	8
Mechanical Dimensions .....	9
Pad Configuration .....	10
Solder Pad Design .....	10
Relative Spectral Distribution vs. Wavelength Characteristics .....	11
Typical Light Output Characteristics.....	15
Typical Forward Current Characteristics.....	16
Typical Luminous Efficacy .....	17
Current Derating Curves.....	19
Typical Radiation Patterns.....	21
Emitter Pocket Tape Packaging.....	22
Emitter Reel Packaging .....	23
Product Binning and Labeling .....	24
Luminous Flux Bins.....	25
4100K Neutral-White Bin Structure .....	26
5650K Cool-White Bin Structure .....	27
LUXEON Rebel ES ANSI 1/4th Quadrant Color Bin Structure .....	29
ANSI 1/4th quadrant color bin structure for LXW9-PW27, LXW9-PW30, LXW8-PW35, LXW8-PW40 and LXW8-PW50 emitters.....	29
LUXEON Rebel ES ANSI 1/4th Quadrant Bin Structure .....	32
ANSI 1/4th quadrant bin structure for LXH7-PW40 emitter .....	32
Forward Voltage Bins.....	34

# General Product Information

## Product Nomenclature

LUXEON Rebel ES is tested and binned at 700 mA, with current pulse duration of 20 ms. All characteristic charts where the thermal pad is kept at constant temperature (25°C typically) are measured with current pulse duration of 20 ms. Under these conditions, junction temperature and thermal pad temperature are the same.

The LUXEON Rebel ES family of emitters contain a series of LEDs designed for Illumination applications.

The part number designation for the LXML series is explained as follows: L X M L - A B C B

Where:

- A — designates radiation pattern (value P for Lambertian)
- B — designates color (W for White)
- C — designates color variant (C for Cool-White, N for Neutral-White)
- D — designates test current (value 2 for 700 mA)

The part number designation for the LXW8 series is explained as follows: L X W A - B C D E

Where:

- A — designates minimum CRI performance (value 8 = 80 minimum and 9 = 90 minimum)
- B — designates radiation pattern (value P for Lambertian)
- C — designates color (value W = White)
- D & E — designates nominal ANSI CCT (value 27 = 2700K, 30 = 3000K, 35 = 3500K, 40 = 4000K and 50 = 5000K)

The part number designation for the LXH7 series is explained as follows: L X H A - B C D E

Where:

- A — designates minimum CRI performance (value 7 = 70 minimum)
- B — designates radiation pattern (value P for Lambertian)
- C — designates color (value W = White)
- D & E — designates nominal ANSI CCT (value 40 = 4000K)

Therefore products tested and binned at 700 mA follow the part numbering scheme: L X M L - P W x 2, L X W x - P W x x and L X H 7 - P W x x

## Average Lumen Maintenance Characteristics

Lumen maintenance for solid state lighting devices (LEDs) is typically defined in terms of the percentage of initial light output remaining after a specified period of time. Philips Lumileds projects that LUXEON Rebel ES products will deliver, on average, 70% lumen maintenance (L70) at 50,000 hours of operation at a forward current of 1000 mA. This projection is based on constant current operation with junction temperature maintained at or below 135°C. This performance is based on independent test data, Philips Lumileds historical data from tests run on similar material systems, and internal LUXEON reliability testing. Observation of design limits included in this data sheet is required in order to achieve this projected lumen maintenance.

## Environmental Compliance

Philips Lumileds is committed to providing environmentally friendly products to the solid-state lighting market. LUXEON Rebel ES is compliant to the European Union directives on the restriction of hazardous substances in electronic equipment, namely the RoHS and REACH directives. Philips Lumileds will not intentionally add the following restricted materials to the LUXEON Rebel ES: lead, mercury, cadmium, hexavalent chromium, polybrominated biphenyls (PBB) or polybrominated diphenyl ethers (PBDE).

# Product Selection

## Product Selection for LUXEON Rebel ES Thermal Pad Temperature = 25°C

**Table 1.**

Performance at Test Current						
Nominal CCT/ Color	Part Number	Minimum CRI	Typical CRI	Minimum Luminous Flux (lm) <sup>[1] [2]</sup>	Test Current (mA)	
4100K Neutral-White	LXML-PWN2	60	65	200	700	
5650K Cool-White	LXML-PWC2	60	70	200	700	
2700K	LXW9-PW27	90	95	120	700	
3000K	LXW9-PW30	90	95	120	700	
3500K	LXW8-PW35	80	85	160	700	
4000K	LXH7-PW40	70	75	180	700	
4000K	LXW8-PW40	80	85	170	700	
5000K	LXW8-PW50	80	85	180	700	

Notes for Table 1:

- I. Minimum luminous flux performance within published operating conditions. Philips Lumileds maintains a tolerance of  $\pm 6.5\%$  on luminous flux measurements.

## Typical Luminous Flux Characteristics at 350 mA, 700 mA and 1000 mA for LUXEON Rebel ES, Thermal Pad Temperature = 25°C

**Table 2.**

Nominal CCT/ Color	Part Number	Typical Luminous Flux (lm) @ 350 mA Forward Current	Typical Luminous Flux (lm) @ 700 mA Forward Current	Typical Luminous Flux (lm) @ 1000 mA Forward Current
4100K Neutral-White	LXML-PWN2	130	230	310
5650K Cool-White	LXML-PWC2	135	235	320
2700K	LXW9-PW27	75	135	184
3000K	LXW9-PW30	81	145	197
3500K	LXW8-PW35	103	185	252
4000K	LXH7-PW40	114	205	279
4000K	LXW8-PW40	106	190	258
5000K	LXW8-PW50	111	200	272

# Optical Characteristics

## LUXEON Rebel ES at Test Current <sup>[1]</sup> Thermal Pad Temperature = 25°C

**Table 3.**

Nominal CCT/ Color	Part Number	Color Temperature <sup>[2]</sup> CCT			Typical Total Included Angle <sup>[3]</sup> (degrees) $\theta_{0.90V}$	Typical Viewing Angle <sup>[4]</sup> (degrees) 2 $\theta_{1/2}$
		Minimum	Typical	Maximum		
4100K Neutral-White	LXML-PWN2	3500 K	4100 K	4500 K	160	120
5650K Cool-White	LXML-PWC2	4500 K	5650 K	10000 K	160	120
2700K	LXW9-PW27	2580 K	2725 K	2870 K	160	120
3000K	LXW9-PW30	2870 K	3045 K	3220 K	160	120
3500K	LXW8-PW35	3220 K	3465 K	3710 K	160	120
4000K	LXH7-PW40	3710 K	3985 K	4260 K	160	120
4000K	LXW8-PW40	3710 K	3985 K	4260 K	160	120
5000K	LXW8-PW50	4745 K	5028 K	5311 K	160	120

**Notes for Table 3:**

1. Test current is 700 mA for all LXML-PWx2, LXWx-PWxx and LXH7-PWxx emitters.
2. CCT  $\pm 5\%$  tester tolerance.
3. Total angle at which 90% of total luminous flux is captured.
4. Viewing angle is the off axis angle from lamp centerline where the luminous intensity is  $\frac{1}{2}$  of the peak value.

# Electrical Characteristics

## Electrical Characteristics at 700 mA for LUXEON Rebel ES Thermal Pad Temperature = 25°C

**Table 4.**

Nominal CCT/ Color	Part Number	Forward Voltage $V_f$ [1]			Typical Temperature Coefficient of Forward Voltage [2] $\Delta V_f / \Delta T_j$	Typical Thermal Resistance Junction to Thermal Pad ( $^{\circ}\text{C}/\text{W}$ ) $R\theta_{j-c}$
		Min.	Typ.	Max.		
4100K Neutral-White	LXML-PWN2	2.5	3.0	3.5	-2.0 to -4.0	6
5650K Cool-White	LXML-PWC2	2.5	3.0	3.5	-2.0 to -4.0	6
2700K	LXW9-PW27	2.5	3.0	3.5	-2.0 to -4.0	6
3000K	LXW9-PW30	2.5	3.0	3.5	-2.0 to -4.0	6
3500K	LXW8-PW35	2.5	3.0	3.5	-2.0 to -4.0	6
4000K	LXH7-PW40	2.5	3.0	3.5	-2.0 to -4.0	6
4000K	LXW8-PW40	2.5	3.0	3.5	-2.0 to -4.0	6
5000K	LXW8-PW50	2.5	3.0	3.5	-2.0 to -4.0	6

Notes for Table 4:

1. Philips Lumileds maintains a tolerance of  $\pm 0.06\text{V}$  on forward voltage measurements.
2. Measured between  $25^{\circ}\text{C} = T_j = 110^{\circ}\text{C}$  at  $I_f = 700\text{ mA}$ .

## Typical Electrical Characteristics at 350 mA, 700 mA and 1000 mA for LUXEON Rebel ES, Thermal Pad Temperature = 25°C

**Table 5.**

Nominal CCT/ Color	Part Number	Typical Forward Voltage $V_f$ (V) @ 350 mA	Typical Forward Voltage $V_f$ (V) @ 700 mA	Typical Forward Voltage $V_f$ (V) @ 1000 mA
		Forward Current	Forward Current	Forward Current
4100K Neutral-White	LXML-PWN2	2.85	3.00	3.10
5650K Cool-White	LXML-PWC2	2.85	3.00	3.10
2700K	LXW9-PW27	2.85	3.00	3.10
3000K	LXW9-PW30	2.85	3.00	3.10
3500K	LXW8-PW35	2.85	3.00	3.10
4000K	LXH7-PW40	2.85	3.00	3.10
4000K	LXW8-PW40	2.85	3.00	3.10
5000K	LXW8-PW50	2.85	3.00	3.10

Note for Table 5:

- Philips Lumileds maintains a tolerance of  $\pm 0.06\text{V}$  on forward voltage measurements.

## Absolute Maximum Ratings

**Table 6.**

Parameter	4100K Neutral-White, 5650K Cool-White, 2700K, 3000K, 3500K, 4000K and 5000K
DC Forward Current (mA)	1000 mA
Peak Pulsed Forward Current (mA) <sup>[2]</sup>	1200 mA
Average Forward Current (mA)	1000 mA
ESD Sensitivity	< 8000V Human Body Model (HBM) Class 3A JESD22-A114-E
LED Junction Temperature <sup>[1]</sup>	150°C
Operating Case Temperature at 700 mA	-40°C - 135°C
Storage Temperature	-40°C - 135°C
Soldering Temperature	JEDEC 020c 260°C
Allowable Reflow Cycles	3
Autoclave Conditions	121°C at 2 ATM 100% Relative Humidity for 96 Hours Maximum
Reverse Voltage (Vr)	LUXEON Rebel ES LEDs are not designed to be driven in reverse bias

Notes for Table 6:

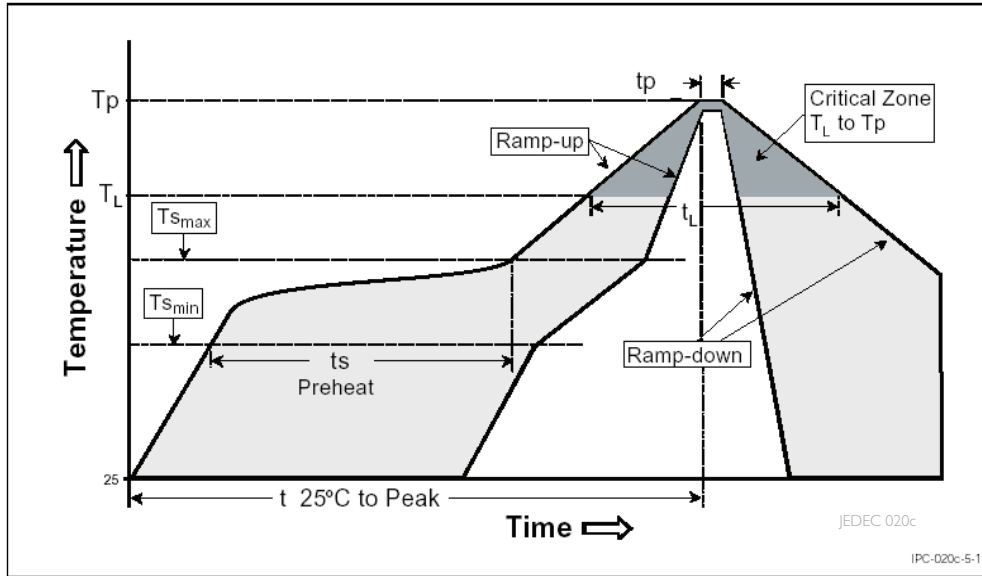
1. Proper current derating must be observed to maintain junction temperature below the maximum.
2. Maximum Rating of 1200 mA Peak Pulsed Forward Current can be applied for device operation not to exceed 60 seconds (cumulative time).

## JEDEC Moisture Sensitivity

**Table 7.**

Level	Soak Requirements			
	Floor Life		Standard	
	Time	Conditions	Time	Conditions
1	unlimited	≤ 30°C / 85% RH	168h + 5 / -0	85°C / 85% RH

# Reflow Soldering Characteristics



Temperature Profile for Table 8.

Table 8.

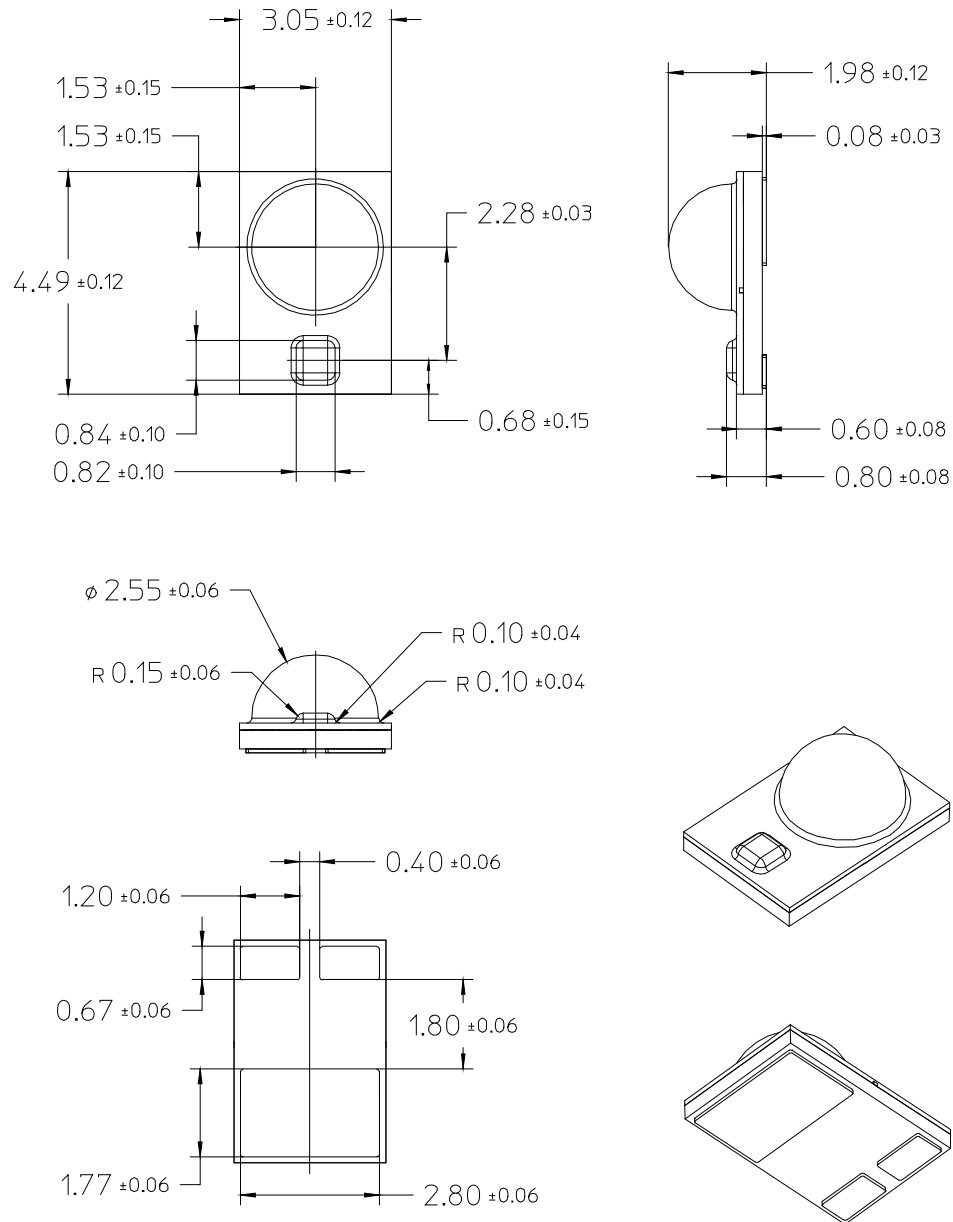
Profile Feature	Lead Free Assembly
Average Ramp-Up Rate ( $T_{s_{max}}$ to $T_p$ )	3°C / second max
Preheat Temperature Min ( $T_{s_{min}}$ )	150°C
Preheat Temperature Max ( $T_{s_{max}}$ )	200°C
Preheat Time ( $t_{s_{min}}$ to $t_{s_{max}}$ )	60 - 180 seconds
Temperature ( $T_L$ )	217°C
Time Maintained Above Temperature ( $T_L$ )	60 - 150 seconds
Peak / Classification Temperature ( $T_p$ )	260°C
Time Within 5°C of Actual Peak Temperature ( $t_p$ )	20 - 40 seconds
Ramp - Down Rate	6°C / second max
Time 25°C to Peak Temperature	8 minutes max

Notes for Table 8:

- All temperatures refer to the application Printed Circuit Board (PCB), measured on the surface adjacent to the package body.
- For additional information on thermal measurement guidelines please refer to Application Brief AB33.



# Mechanical Dimensions



**Figure 1. Package outline drawing.**

Notes for Figure 1:

- Do not handle the device by the lens—care must be taken to avoid damage to the lens or the interior of the device that can be damaged by excessive force to the lens.
- Drawings not to scale.
- All dimensions are in millimeters.
- The thermal pad is electrically isolated from the anode and cathode contact pads.

## Pad Configuration

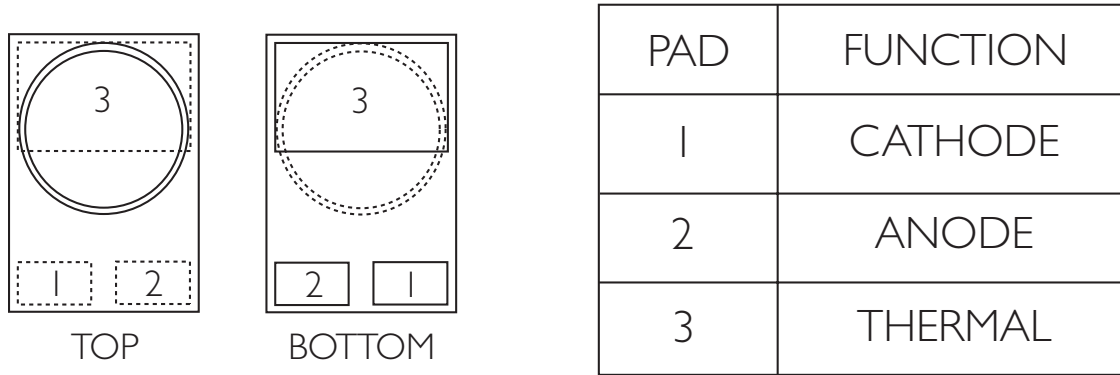


Figure 2. Pad configuration.

Note for Figure 2:

- The Thermal Pad is electrically isolated from the Anode and Cathode contact pads.

## Solder Pad Design

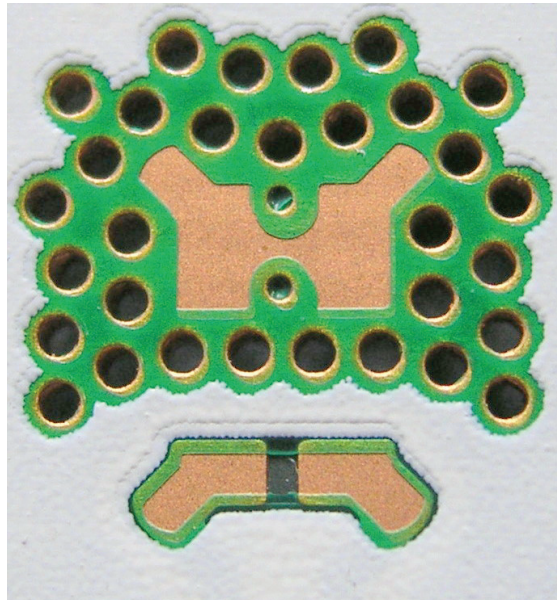


Figure 3. Solder pad layout.

Note for Figure 3:

- The photograph shows the recommended LUXEON Rebel ES layout on Printed Circuit Board (PCB). This design easily achieves a thermal resistance of 7K/W.
- Application Brief AB32 provides extensive details for this layout. Printed Circuit Board layout files (.dmg) are available at [www.philipslumileds.com](http://www.philipslumileds.com) and [www.philipslumileds.cn.com](http://www.philipslumileds.cn.com).

# Relative Spectral Distribution vs. Wavelength Characteristics

**LXML-PWN2 (4100K) Neutral-White at Test Current,  
Thermal Pad Temperature = 25°C**

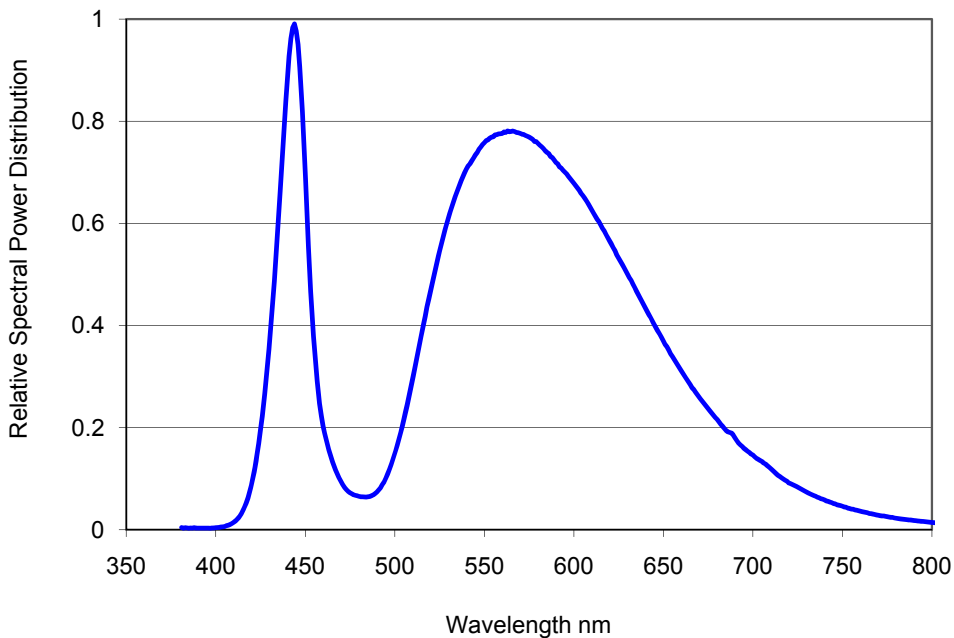


Figure 4. Color spectrum of LXML-PWN2 emitter, integrated measurement.

**LXML-PWC2 (5650K) Cool-White at Test Current,  
Thermal Pad Temperature = 25°C**

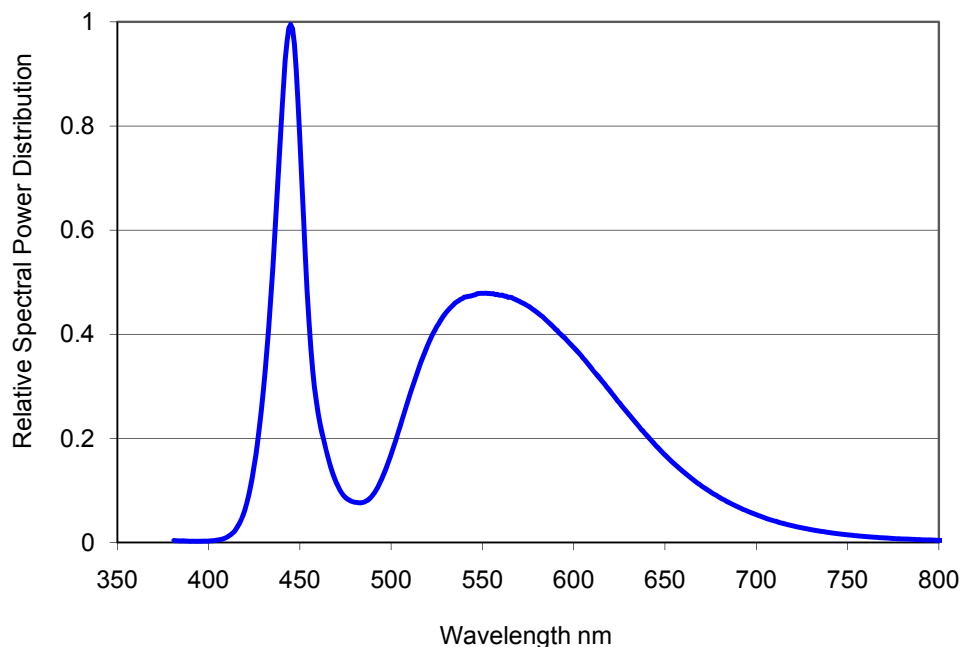


Figure 5. Color spectrum of LXML-PWC2 emitter, integrated measurement.

## LXW9-PW27 (2700K) at Test Current, Thermal Pad Temperature = 25°C

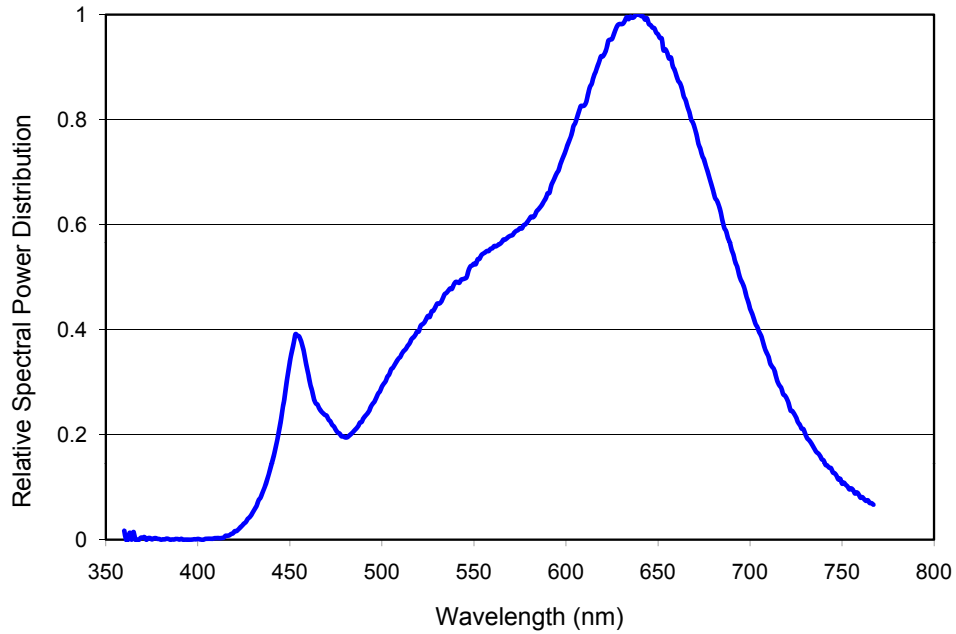


Figure 6. Color spectrum of LXW9-PW27 emitter, integrated measurement.

## LXW9-PW30 (3000K) at Test Current, Thermal Pad Temperature = 25°C

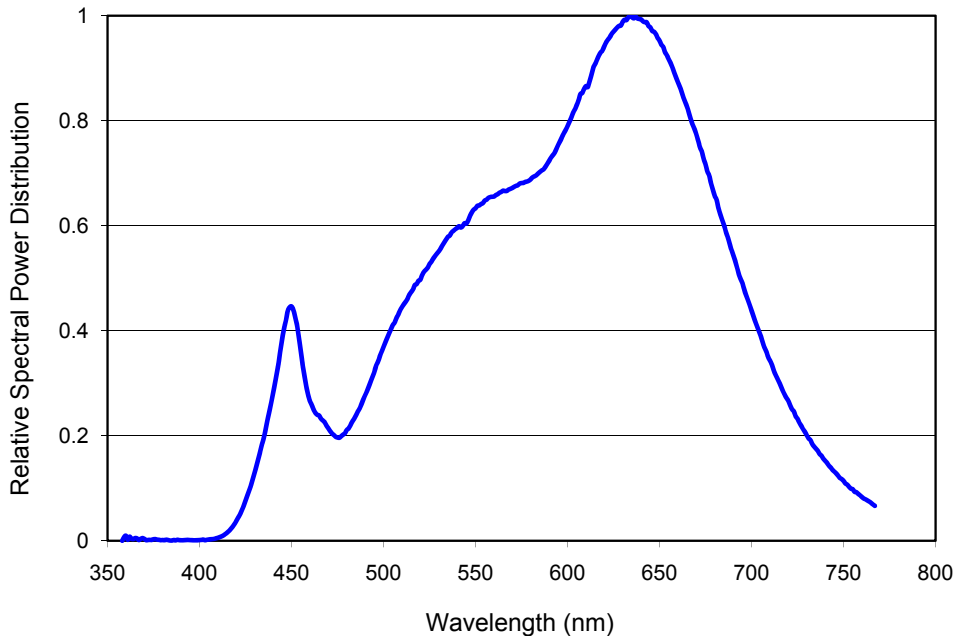


Figure 7. Color spectrum of LXW9-PW30 emitter, integrated measurement.

## LXW8-PW35 (3500K) at Test Current, Thermal Pad Temperature = 25°C

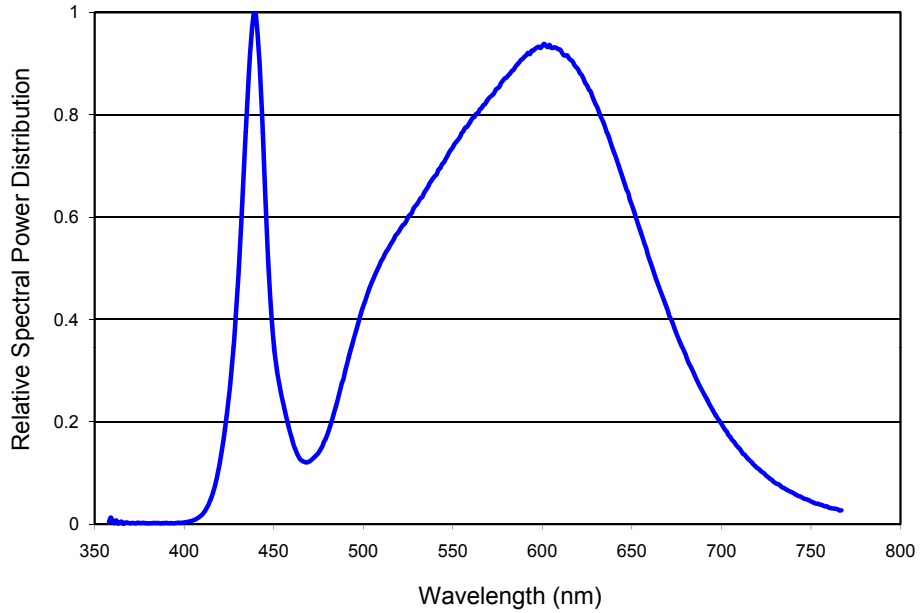


Figure 8. Color spectrum of LXW8-PW35 emitter, integrated measurement.

## LXH7-PW40 (4000K) at Test Current, Thermal Pad Temperature = 25°C

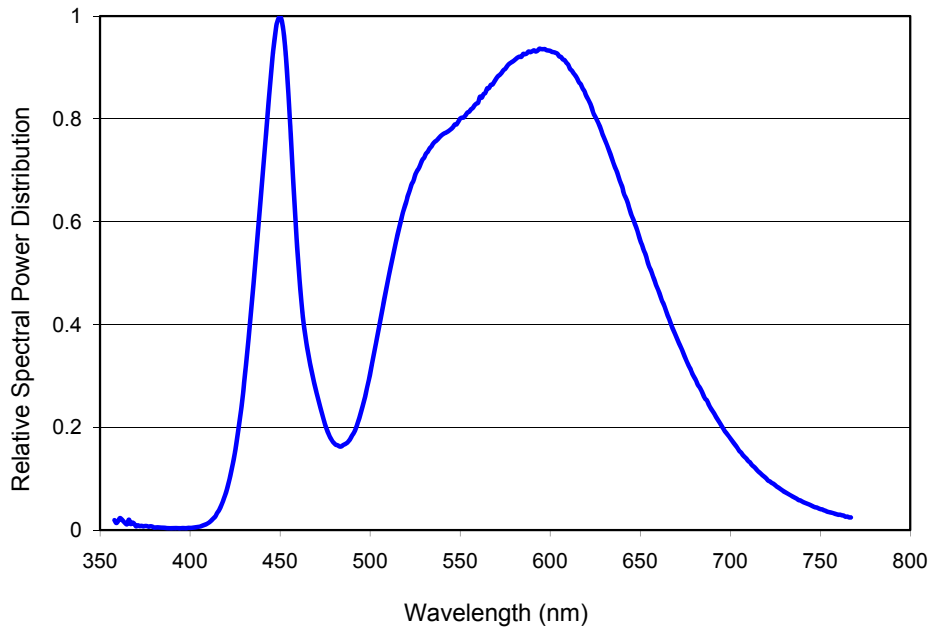


Figure 9. Color spectrum of LXH7-PW40 emitter, integrated measurement.

## LXW8-PW40 (4000K) at Test Current, Thermal Pad Temperature = 25°C

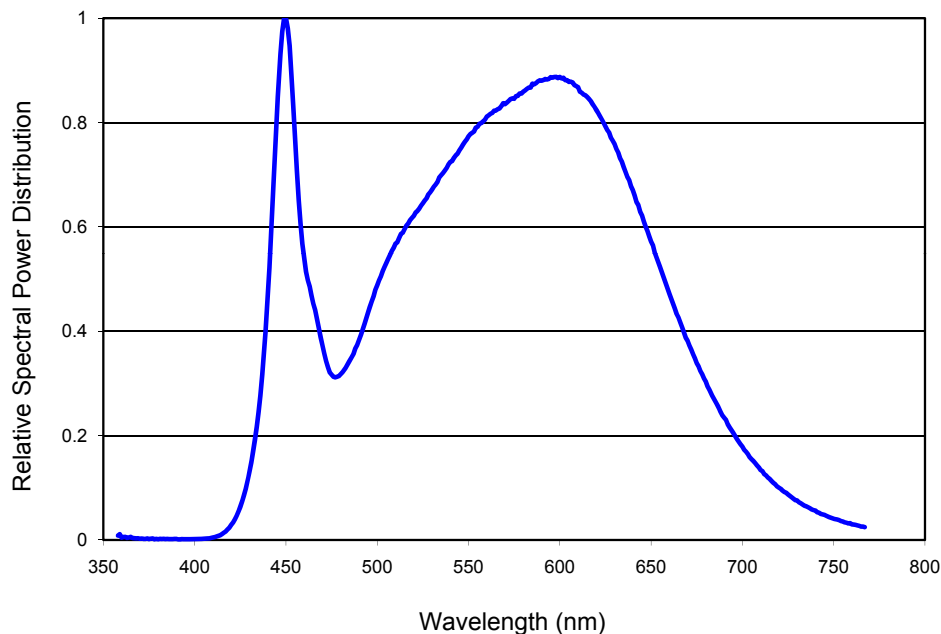


Figure 10. Color spectrum of LXW8-PW40 emitter, integrated measurement.

## LXW8-PW50 (5000K) at Test Current, Thermal Pad Temperature = 25°C

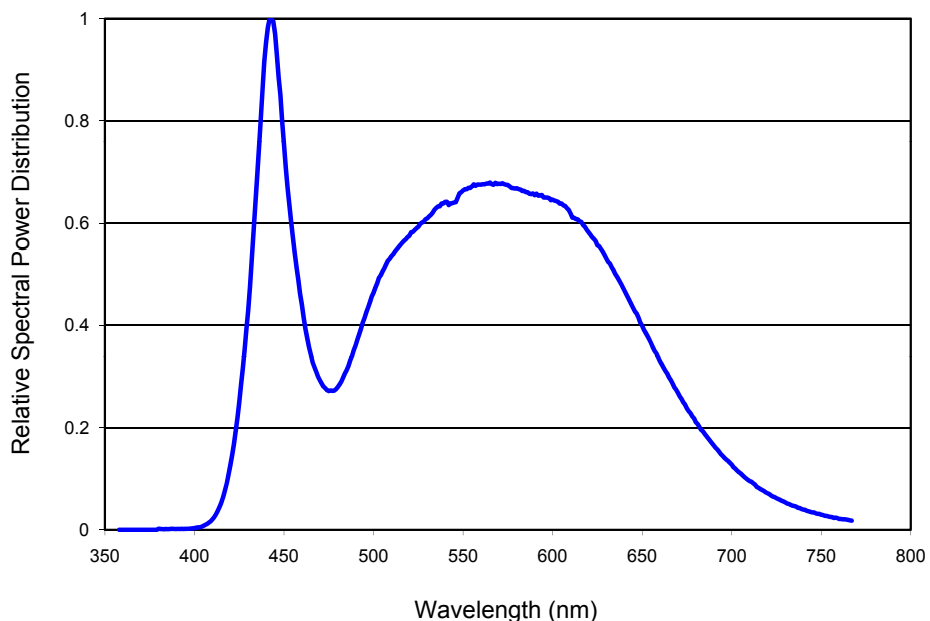


Figure 11. Color spectrum of LXW8-PW50 emitter, integrated measurement.

# Typical Light Output Characteristics

Typical Relative Luminous Flux Vs Temperature for 4100K Neutral-White, 5650K Cool-White, 2700K, 3000K, 3500K, 4000K and 5000K Emitters at Test Current

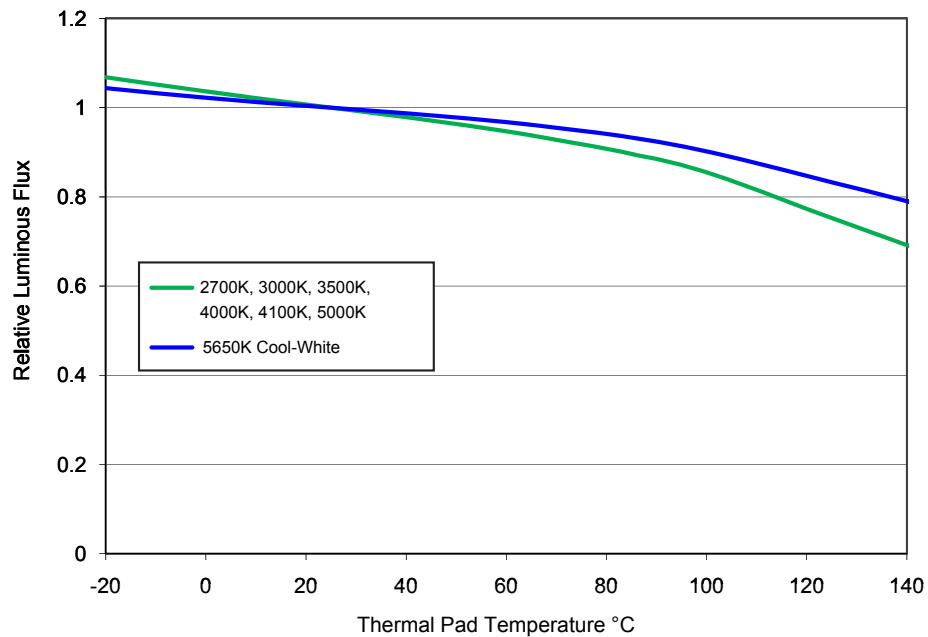


Figure 12. Relative light output vs. thermal pad temperature.

# Typical Forward Current Characteristics

4100K Neutral-White, 5650K Cool-White, 2700K, 3000K, 3500K, 4000K and 5000K at Test Current, Thermal Pad Temperature = 25°C

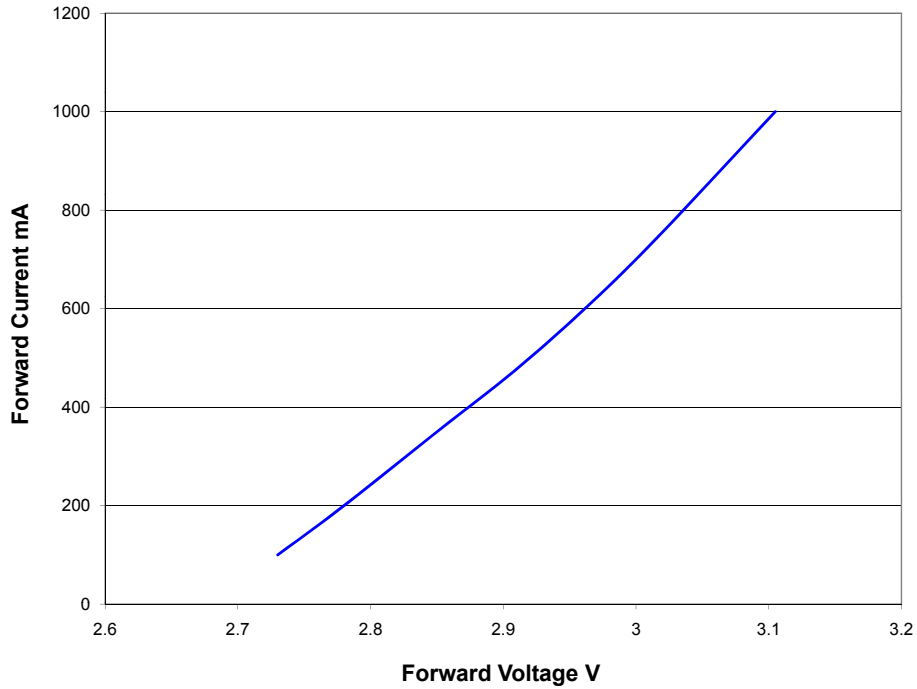


Figure 13. Forward current vs. forward voltage.



# Typical Luminous Efficacy

Typical Luminous Efficacy Characteristic vs. Forward Current for 4100K Neutral-White, 5650K Cool-White, 2700K, 3000K, 3500K, 4000K and 5000K Emitters

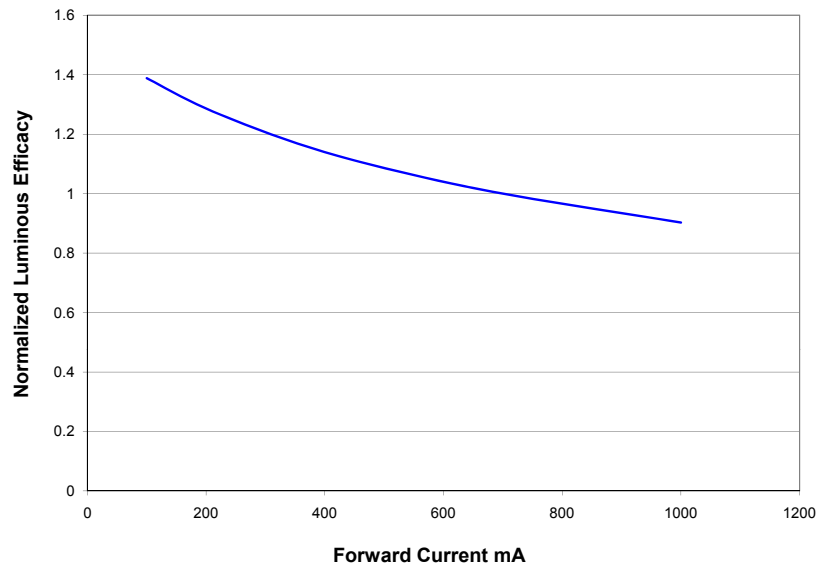


Figure 14. Typical luminous efficacy characteristic vs. forward current, thermal pad temperature = 25°C.

Typical Relative Luminous Flux vs. Forward Current for 4100K Neutral-White, 5650K Cool-White, 2700K, 3000K, 3500K, 4000K and 5000K Emitters. Thermal Pad Temperature = 25°C

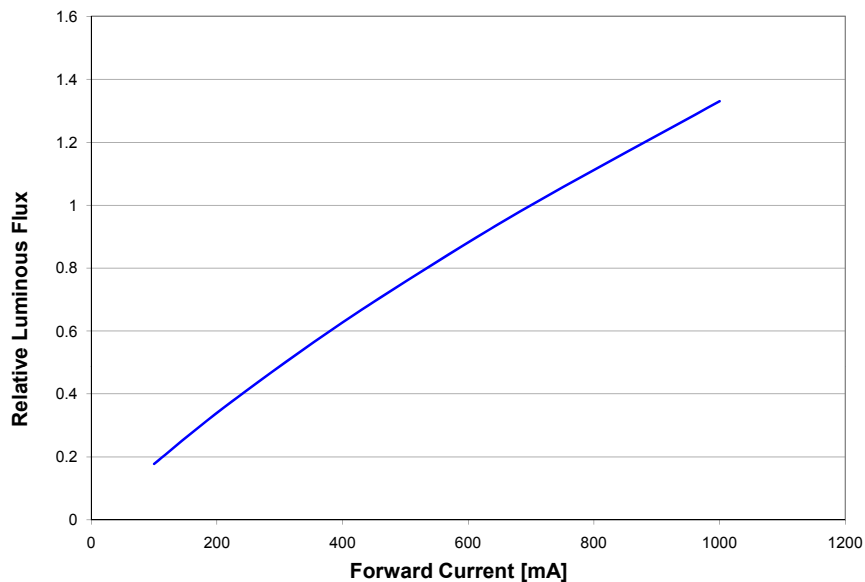


Figure 15. Typical relative luminous flux vs. forward current, thermal pad temperature = 25°C.

## Typical Relative Luminous Efficacy vs. Temperature

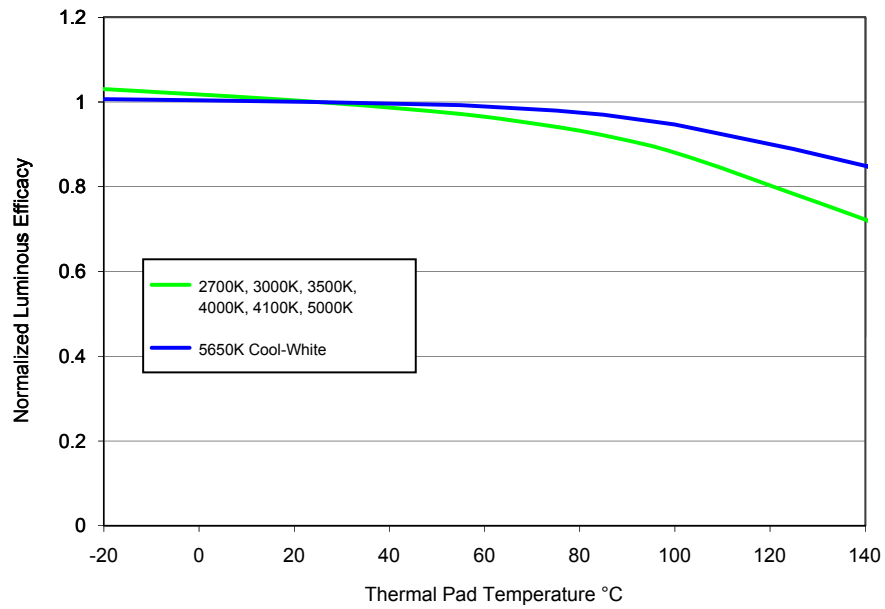


Figure 16. Relative luminous efficacy vs. thermal pad temperature, test current 700 mA.

# Current Derating Curves

## Current Derating Curves at 350 mA Forward Current Operation for 4100K Neutral-White, 5650K Cool-White, 2700K, 3000K, 3500K, 4000K and 5000K Emitters

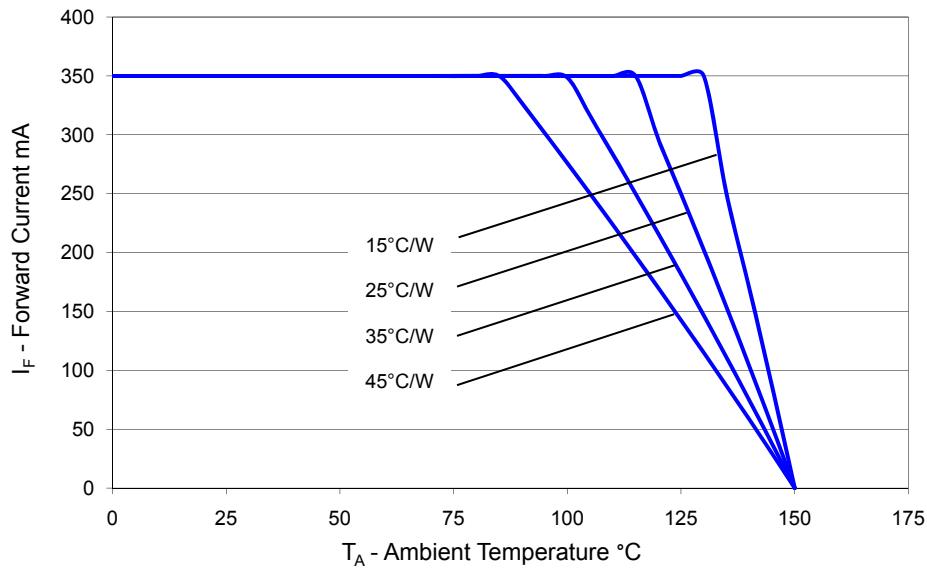


Figure 17. Maximum forward current vs. ambient temperature, based on  $T_{JMAX} = 150^\circ\text{C}$ .

## Current Derating Curves at 700mA Forward Current Operation for 4100K Neutral-White, 5650K Cool-White, 2700K, 3000K, 3500K, 4000K and 5000K Emitters

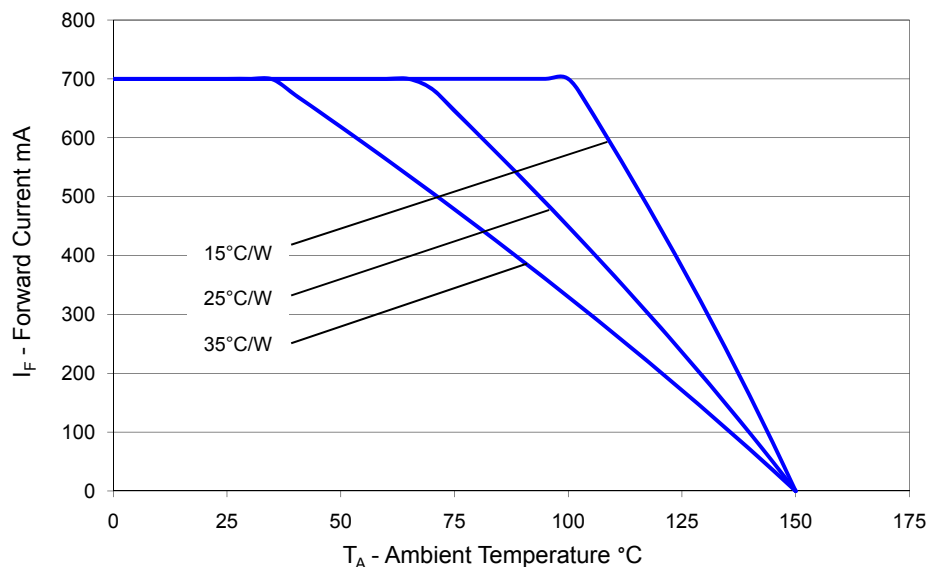


Figure 18. Maximum forward current vs. ambient temperature, based on  $T_{JMAX} = 150^\circ\text{C}$ .

## Current Derating Curves at 1000 mA Forward Current Operation for 4100K Neutral-White, 5650K Cool-White, 2700K, 3000K, 3500K, 4000K and 5000K Emitters

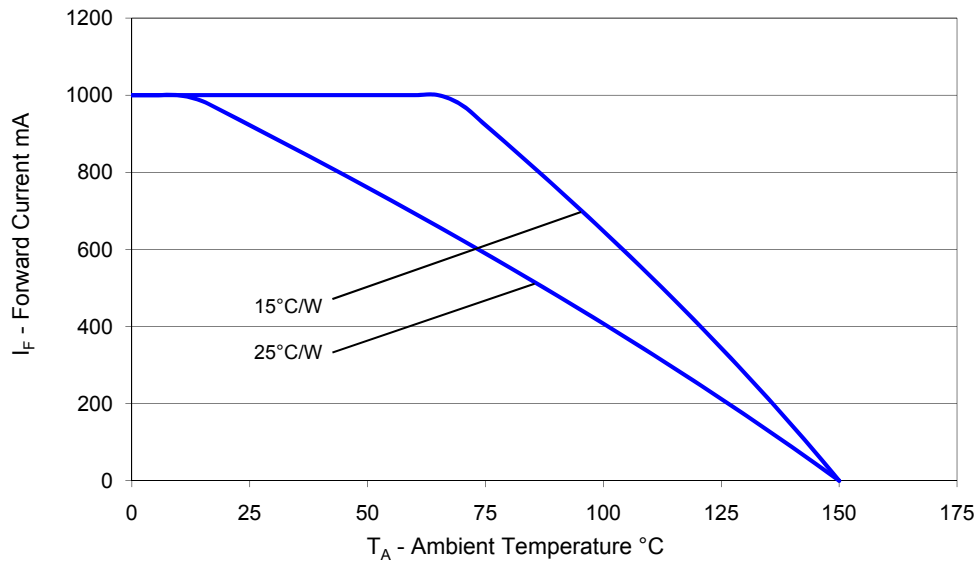
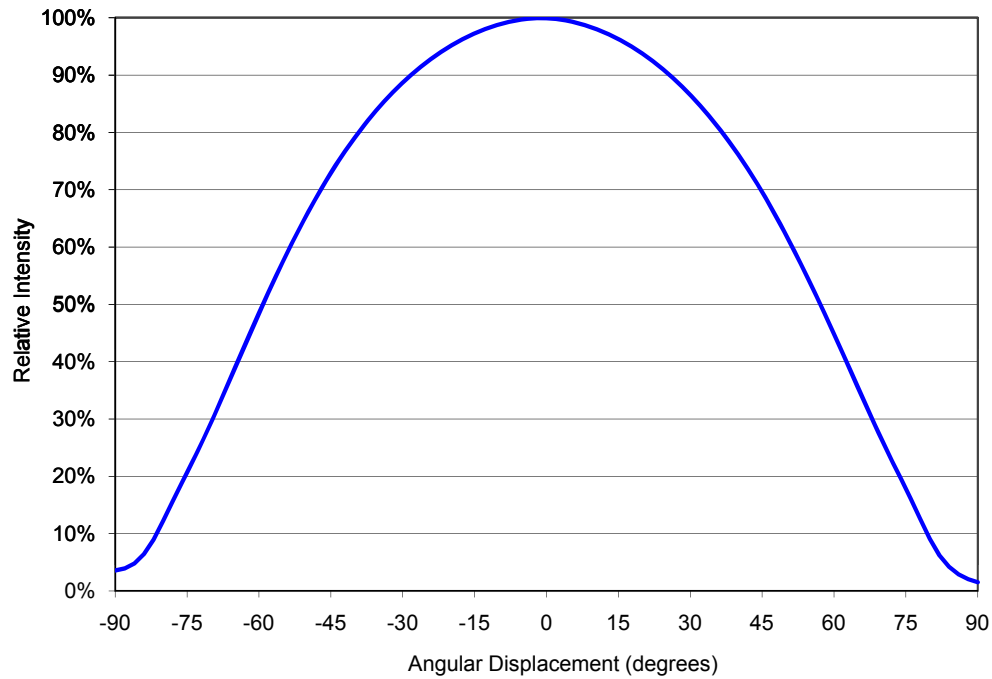


Figure 19. Maximum forward current vs. ambient temperature, based on  $T_{JMAX} = 150^{\circ}\text{C}$ .

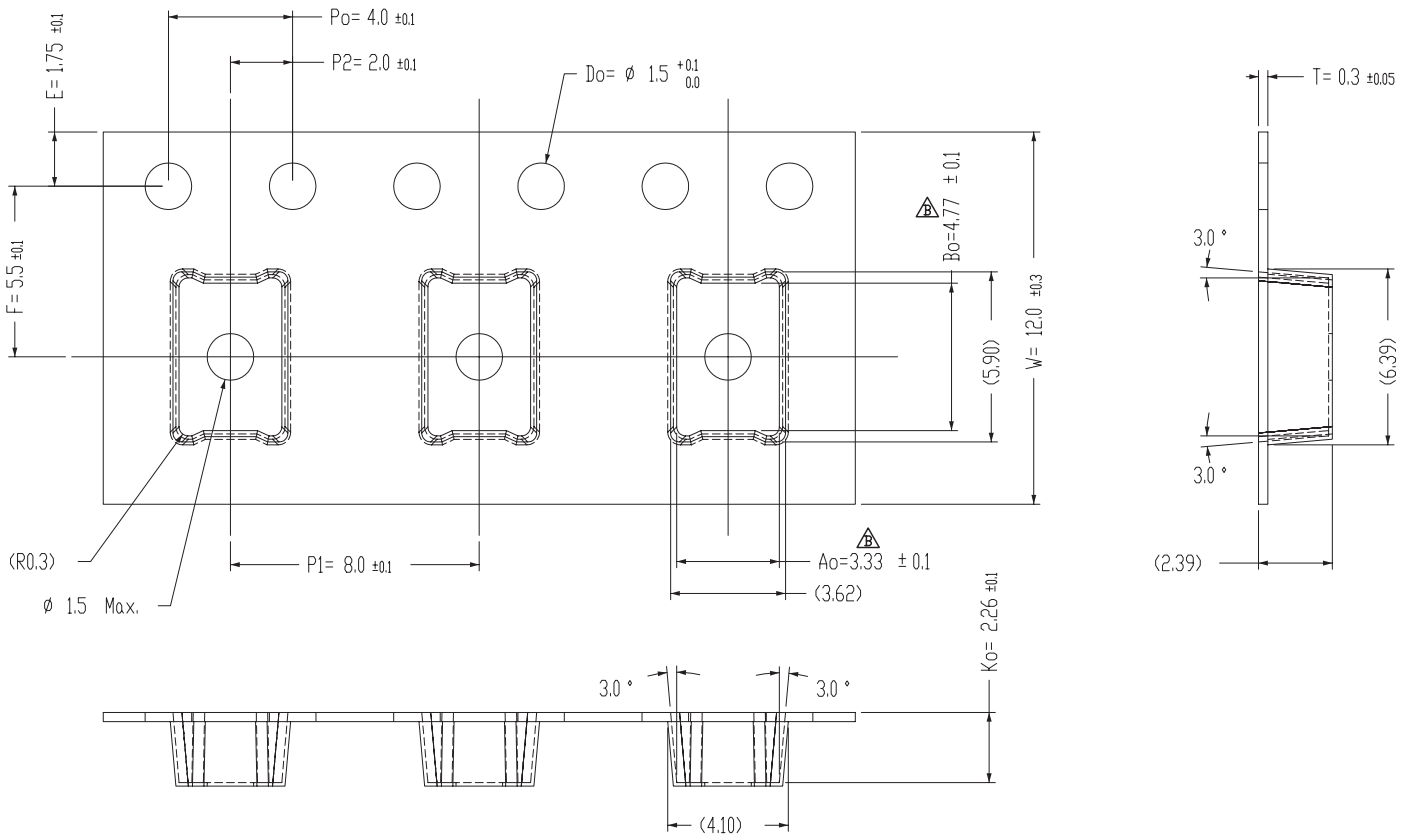
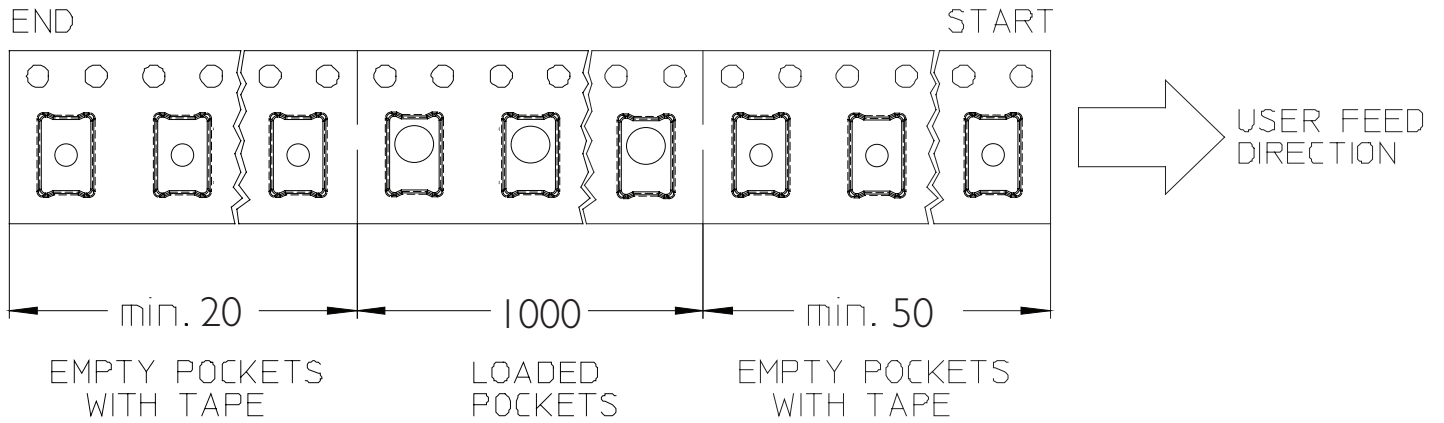
# Typical Radiation Patterns

## Typical Spatial Radiation Pattern for 4100K Neutral-White, 5650K Cool-White, 2700K, 3000K, 3500K, 4000K and 5000K Emitters

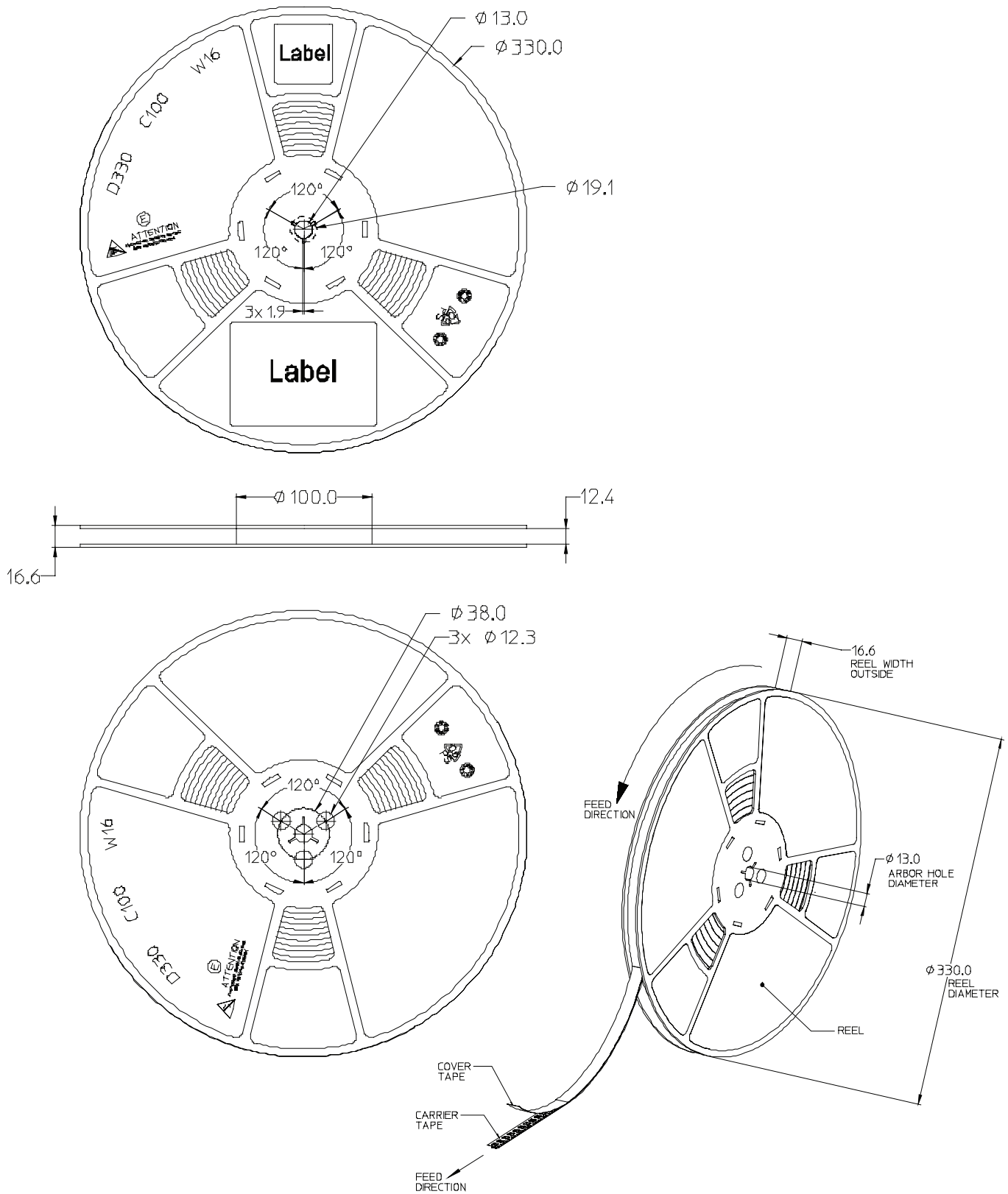


**Figure 20. Typical representative spatial radiation pattern for 4100K neutral-white, 5650K cool-white, 2700K, 3000K 3500K, 4000K and 5000K lambertian.**

# Emitter Pocket Tape Packaging



# Emitter Reel Packaging



# Product Binning and Labeling

## **Purpose of Product Binning**

In the manufacturing of semiconductor products, there is a variation of performance around the average values given in the technical data sheets. For this reason, Philips Lumileds bins the LED components for luminous flux, color and forward voltage ( $V_f$ ).

## **Decoding Product Bin Labeling**

LUXEON Rebel ES emitters are labeled using a four digit alphanumeric code (CAT code) depicting the bin values for emitters packaged on a single reel. All emitters packaged within a reel are of the same 3-variable bin combination. Using these codes, it is possible to determine optimum mixing and matching of products for consistency in a given application.

Reels of LUXEON Rebel ES emitters are labeled with a four digit alphanumeric CAT code following the format below.

ABCD

A = Flux bin (P, Q, R, S etc.)

B and C = Color bin (W0, V0, U0 etc. for LXML-PWx2 series. 7A, 7B, 7C and 7D for LXWx-PWxx series.  
5W, 5X, 5Y and 5Z for LXH7-PW40 emitter)

D =  $V_f$  bin (P, R, S and T)



# Luminous Flux Bins

Table 9 lists the standard photometric luminous flux bins for LUXEON Rebel ES emitters (tested and binned at 700 mA).

Although several bins are outlined, product availability in a particular bin varies by production run and by product performance. Not all bins are available in all colors.

**Table 9.**

Flux Bins		
Bin Code	Minimum Photometric Flux (lm)	Maximum Photometric Flux (lm)
P	120	140
Q	140	160
R	160*	180
S	180	200
T	200	220
U	220	240
V	240	260
W	260	280
X	280	300

\* 170 lm for LXW8-PW40

# 4100K Neutral-White Bin Structure

4100K Neutral-White LUXEON Rebel ES emitters are tested and binned by x,y coordinates. 12 Color Bins, CCT Range 3,500K to 4,500K.

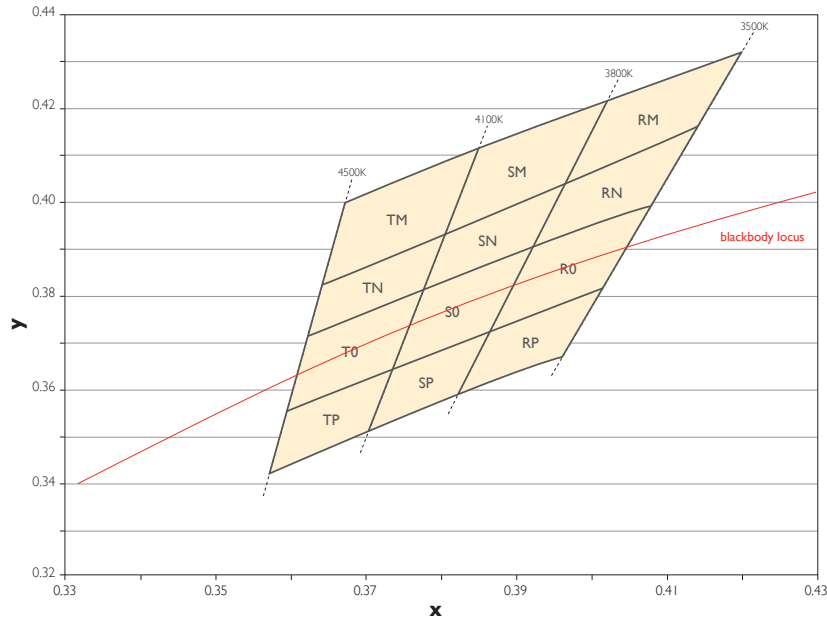


Figure 21. 4100K Neutral-White bin structure.

Table 10.

4100K Neutral-White Bin Coordinates

Bin Code	X	Y	Typical CCT (K)	Bin Code	X	Y	Typical CCT (K)
TM	0.367294	0.400290	4300	SO	0.378264	0.382458	3950
	0.385953	0.412995			0.392368	0.390932	
	0.381106	0.393747			0.387071	0.373899	
	0.364212	0.382878			0.374075	0.365822	
TN	0.364212	0.382878	4300	SP	0.374075	0.365822	3950
	0.381106	0.393747			0.387071	0.373899	
	0.378264	0.382458			0.382598	0.359515	
TO	0.362219	0.371616	4300	RM	0.370582	0.351953	3650
	0.378264	0.382458			0.402270	0.422776	
	0.374075	0.365822			0.420940	0.432618	
	0.359401	0.355699			0.414776	0.416097	
TP	0.359401	0.355699	4300	RN	0.396279	0.403508	3650
	0.374075	0.365822			0.414776	0.416097	
	0.370582	0.351953			0.408593	0.399525	
SM	0.357079	0.342581	3950	RO	0.392368	0.390932	3650
	0.385953	0.412995			0.402113	0.382156	
	0.402270	0.422776			0.387071	0.373899	
SN	0.396279	0.403508	3950	RP	0.387071	0.373899	3650
	0.392368	0.390932			0.402113	0.382156	
	0.378264	0.382458			0.396564	0.367284	
					0.382598	0.359515	

Note for Table 10:

- Philips Lumileds maintains a tester tolerance of  $\pm 0.005$  on x,y color coordinates.

# 5650K Cool-White Bin Structure

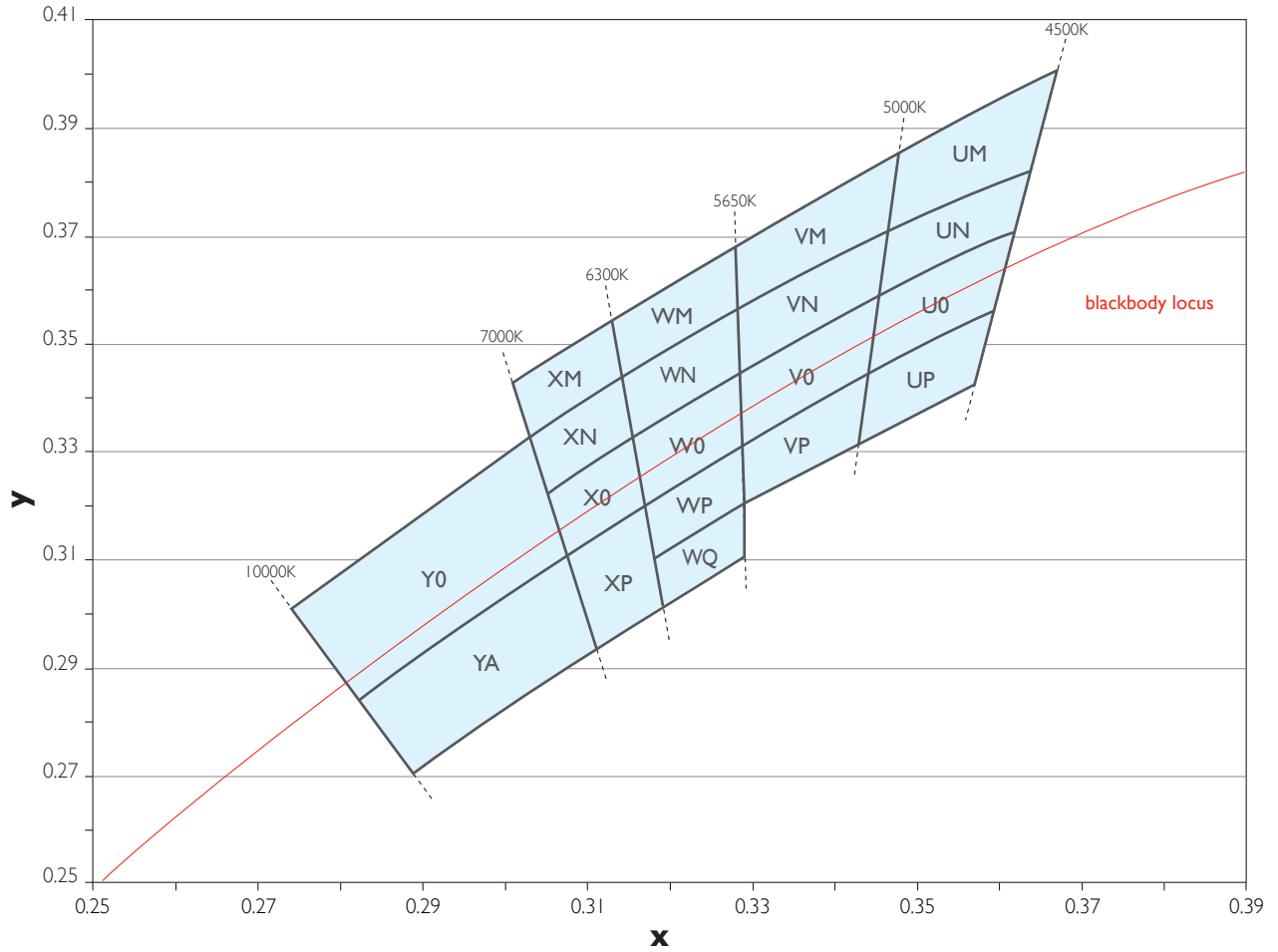


Figure 22. 5650K Cool-White bin structure.

**Table II.**

**5650K Cool-White Bin Coordinates**

Bin Code	X	Y	Typical CCT (K)	Bin Code	X	Y	Typical CCT (K)
Y0	0.274238	0.300667	8000	WQ	0.318606	0.310201	6000
	0.303051	0.332708			0.329393	0.320211	
	0.307553	0.310778			0.329544	0.310495	
	0.282968	0.283772			0.319597	0.301303	
YA	0.282968	0.283772	8000	VM	0.328636	0.368952	5300
	0.307553	0.310778			0.348147	0.385629	
	0.311163	0.293192			0.346904	0.371742	
	0.289922	0.270316			0.328823	0.356917	
XM	0.301093	0.342244	6700	VN	0.328823	0.356917	5300
	0.313617	0.354992			0.346904	0.371742	
	0.314792	0.344438			0.345781	0.359190	
	0.303051	0.332708			0.329006	0.345092	
XN	0.303051	0.332708	6700	V0	0.329006	0.345092	5300
	0.314792	0.344438			0.345781	0.359190	
	0.316042	0.333222			0.344443	0.344232	
	0.305170	0.322386			0.329220	0.331331	
X0	0.305170	0.322386	6700	VP	0.329220	0.331331	5300
	0.316042	0.333222			0.344443	0.344232	
	0.317466	0.320438			0.343352	0.332034	
	0.307553	0.310778			0.329393	0.320211	
XP	0.307553	0.310778	6700	UM	0.348147	0.385629	4750
	0.317466	0.320438			0.367294	0.400290	
	0.319597	0.301303			0.364212	0.382878	
	0.311163	0.293192			0.346904	0.371742	
WM	0.313617	0.354992	6000	UN	0.346904	0.371742	4750
	0.328636	0.368952			0.364212	0.382878	
	0.328823	0.356917			0.362219	0.371616	
	0.314792	0.344438			0.345781	0.359190	
WN	0.314792	0.344438	6000	U0	0.345781	0.359190	4750
	0.328823	0.356917			0.362219	0.371616	
	0.329006	0.345092			0.359401	0.355699	
	0.316042	0.333222			0.344443	0.344232	
W0	0.316042	0.333222	6000	UP	0.344443	0.344232	4750
	0.329006	0.345092			0.359401	0.355699	
	0.329220	0.331331			0.357079	0.342581	
	0.317466	0.320438			0.343352	0.332034	
WP	0.317466	0.320438	6000				
	0.329220	0.331331					
	0.329393	0.320211					
	0.318606	0.310201					

Note for Table II:

- Philips Lumileds maintains a tester tolerance of  $\pm 0.005$  on x,y color coordinates.

# LUXEON Rebel ES ANSI I/4th Quadrant Color Bin Structure

ANSI I/4th quadrant color bin structure for LXW9-PW27, LXW9-PW30, LXW8-PW35, LXW8-PW40 and LXW8-PW50 emitters

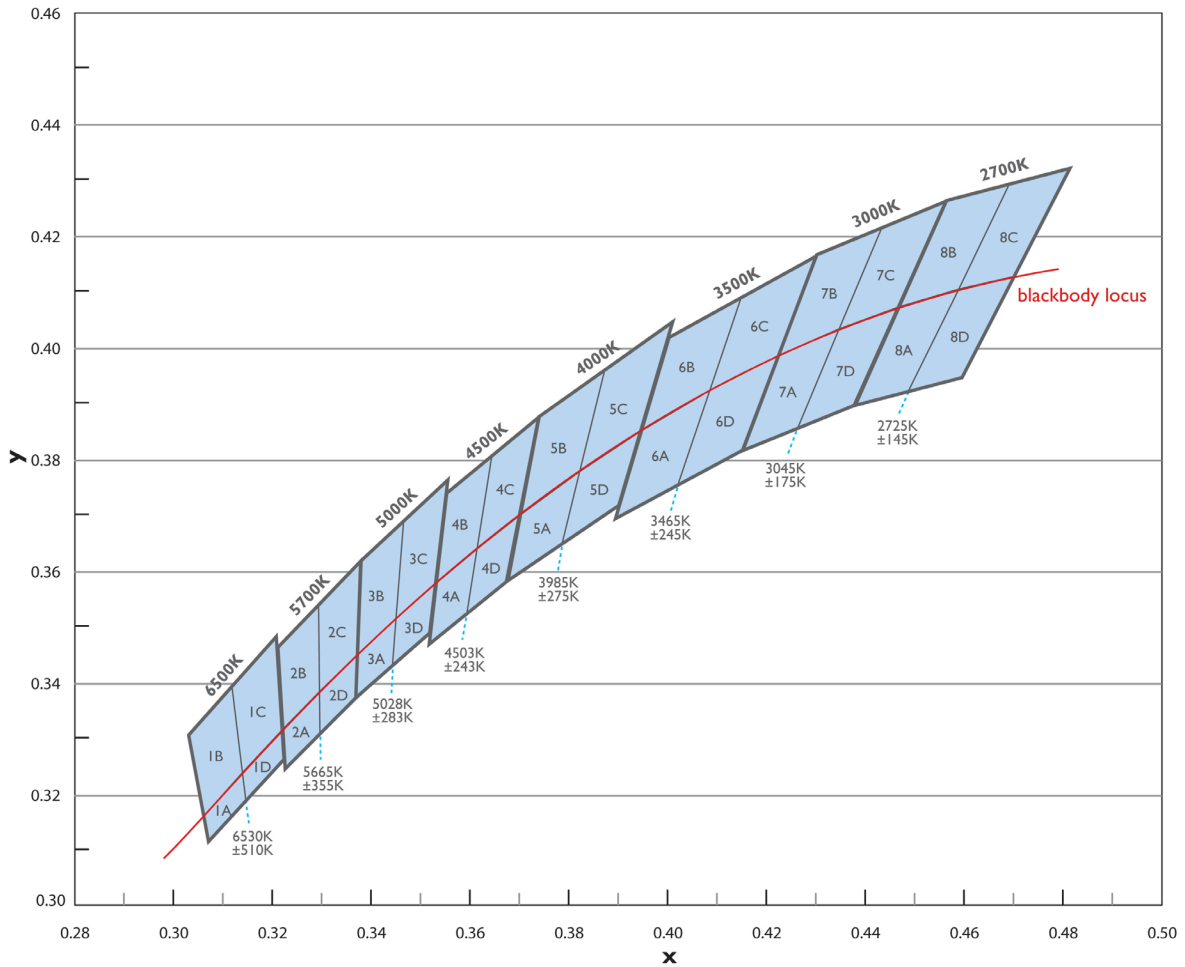


Figure 23. LUXEON Rebel ES ANSI I/4th quadrant color bin structure.

# LUXEON Rebel ES ANSI 1/4<sup>th</sup> Quadrant Bin Coordinates, Continued

LUXEON Rebel ES emitters are tested and binned by x,y coordinates.

32 Color Bins, CCT Range 2580K to 7040K

**Table 12.**

LUXEON Rebel ES ANSI 1/4th quadrant Bin Coordinates							
Nominal CCT	Bin Code	x	y	Nominal CCT	Bin Code	x	y
2700K	8A	0.458614	0.410315	3500K	6A	0.408216	0.392153
		0.446470	0.407117			0.394131	0.384815
		0.437300	0.389300			0.388900	0.369000
		0.448286	0.391847			0.401706	0.375155
	8B	0.468732	0.428946		6B	0.414622	0.408937
		0.456200	0.426000			0.399600	0.401500
		0.446470	0.407117			0.394131	0.384815
		0.458614	0.410315			0.408216	0.392153
	8C	0.481300	0.431900		6C	0.429900	0.416500
		0.468732	0.428946			0.414622	0.408937
		0.458614	0.410315			0.408216	0.392153
		0.469954	0.412602			0.422071	0.398417
	8D	0.469954	0.412602		6D	0.422071	0.398417
		0.458614	0.410315			0.408216	0.392153
		0.448286	0.391847			0.401706	0.375155
		0.459300	0.394400			0.414700	0.381400
3000K	7A	0.434392	0.403186	4000K	5A	0.381883	0.377641
		0.422071	0.398417			0.369655	0.369740
		0.414700	0.381400			0.367000	0.357800
		0.425959	0.385336			0.378297	0.364637
	7B	0.442994	0.421230		5B	0.386955	0.395809
		0.429900	0.416500			0.373600	0.387400
		0.422071	0.398417			0.369655	0.369740
		0.434392	0.403186			0.381883	0.377641
	7C	0.456200	0.426000		5C	0.400600	0.404400
		0.442994	0.421230			0.386955	0.395809
		0.434392	0.403186			0.381883	0.377641
		0.446470	0.407117			0.394131	0.384815
	7D	0.446470	0.407117		5D	0.394131	0.384815
		0.434392	0.403186			0.381883	0.377641
		0.425959	0.385336			0.378297	0.364637
		0.437300	0.389300			0.389800	0.371600

# LUXEON Rebel ES ANSI 1/4<sup>th</sup> Quadrant Bin Coordinates, Continued

LUXEON Rebel ES emitters are tested and binned by x,y coordinates.  
32 Color Bins, CCT Range 2580K to 7040K

**Table 12, Continued.**

LUXEON Rebel ES ANSI 1/4th quadrant color bin coordinates			
Nominal CCT	Bin Code	x	y
5000K	3A	0.344719	0.351301
		0.336916	0.344873
		0.336600	0.336900
		0.343985	0.342749
	3B	0.346260	0.368726
		0.337600	0.361600
		0.336916	0.344873
		0.344719	0.351301
	3C	0.355100	0.376000
		0.346260	0.368726
		0.344719	0.351301
		0.352638	0.357500
	3D	0.352638	0.357500
		0.344719	0.351301
		0.343985	0.342749
		0.351500	0.348700

**Notes for Table 12:**

- Philips Lumileds maintains a tester tolerance of  $\pm 0.005$  on x,y color coordinates.
- Applicable for LXW9-PW27, LXW9-PW30, LXW8-PW35, LXW8-PW40 and LXW8-PW50 emitters.

# LUXEON Rebel ES ANSI I/4th Quadrant Bin Structure

## ANSI I/4th quadrant bin structure for LXH7-PW40 emitter

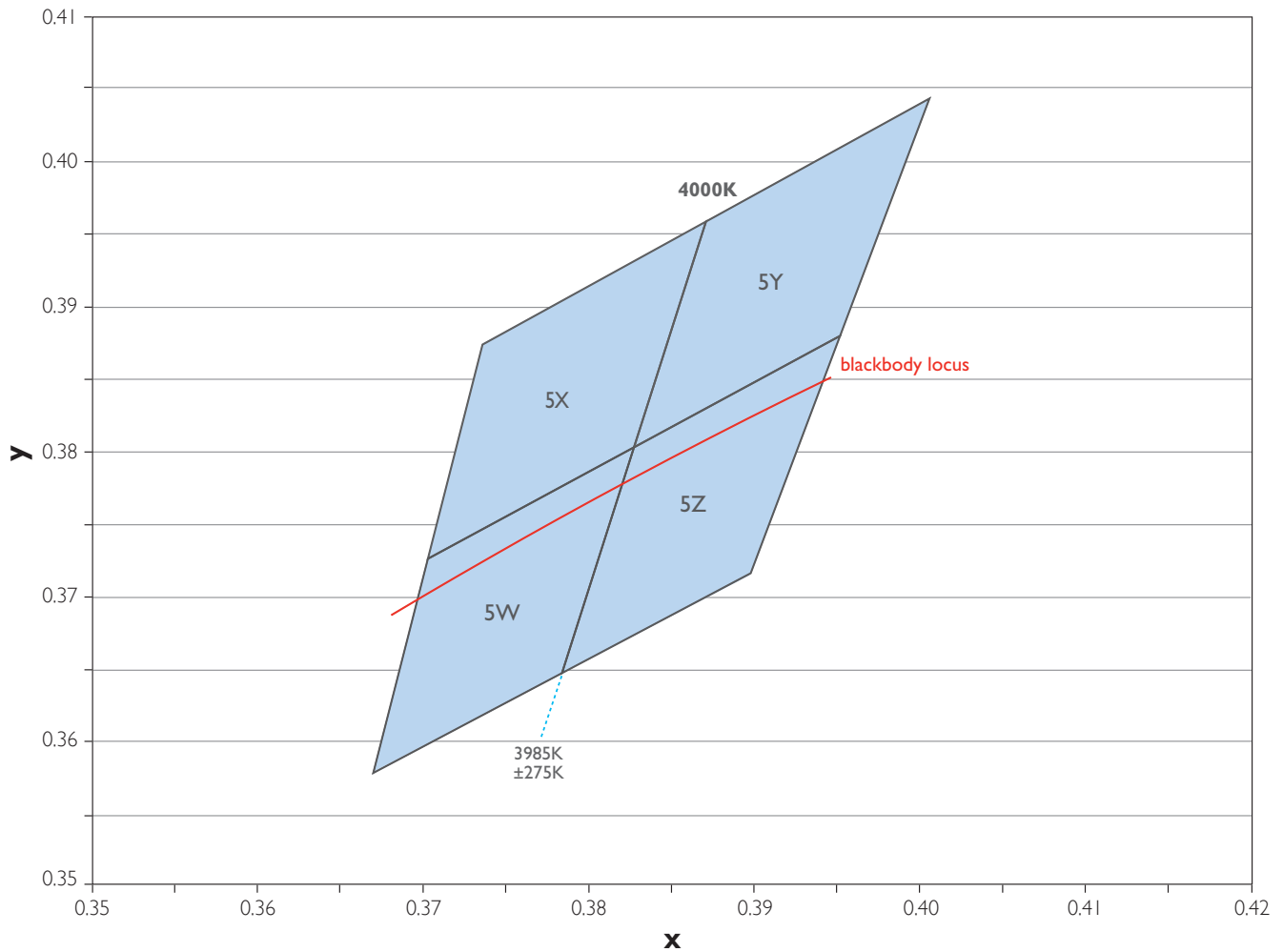


Figure 24. LUXEON Rebel ES ANSI I/4th quadrant bin structure (LXH7-PW40 emitter only).



# LUXEON Rebel ES ANSI 1/4th Quadrant Bin Coordinates for LXH7-PW40 emitter

LUXEON Rebel ES emitters are tested and binned by x,y coordinates.

4 Color Bins, CCT Range 3710K to 4260K

**Table 13.**

LUXEON Rebel ES ANSI 1/4th quadrant Bin Coordinates for LXH7-PW40 emitter			
Nominal CCT	Bin Code	x	y
4000K	5W	0.382750	0.380300
		0.370300	0.372600
		0.367000	0.357800
		0.378400	0.364700
	5X	0.382750	0.380300
		0.387100	0.395900
		0.373600	0.387400
		0.370300	0.372600
	5Y	0.382750	0.380300
		0.395200	0.388000
		0.400600	0.404400
		0.387100	0.395900
	5Z	0.382750	0.380300
		0.378400	0.364700
		0.389800	0.371600
		0.395200	0.388000

# Forward Voltage Bins

Table 14 lists minimum and maximum  $V_f$  bin values per emitter (tested and binned at 700 mA). Although several bins are outlined, product availability in a particular bin varies by production run and by product performance.

**Table 14.**

$V_f$  Bins

Bin Code	Minimum Forward Voltage (V)	Maximum Forward Voltage (V)
P	2.50	2.75
R	2.75	3.00
S	3.00	3.25
T	3.25	3.50

# Company Information

Philips Lumileds is a leading provider of power LEDs for everyday lighting applications. The company's records for light output, efficacy and thermal management are direct results of the ongoing commitment to advancing solid-state lighting technology and enabling lighting solutions that are more environmentally friendly, help reduce CO<sub>2</sub> emissions and reduce the need for power plant expansion. Philips Lumileds LUXEON® LEDs are enabling never before possible applications in outdoor lighting, shop lighting, home lighting, digital imaging, display and automotive lighting.

Philips Lumileds is a fully integrated supplier, producing core LED material in all three base colors, (red, green, blue) and white. Philips Lumileds has R&D centers in San Jose, California and in the Netherlands, and production capabilities in San Jose, Singapore and Penang, Malaysia. Founded in 1999, Philips Lumileds is the high flux LED technology leader and is dedicated to bridging the gap between solid-state technology and the lighting world. More information about the company's LUXEON LED products and solid-state lighting technologies can be found at [www.philipslumileds.com](http://www.philipslumileds.com).

[www.philipslumileds.com](http://www.philipslumileds.com)  
[www.philipslumileds.cn.com](http://www.philipslumileds.cn.com)  
[www.futurelightingsolutions.com](http://www.futurelightingsolutions.com)

For technical assistance or the location of your nearest sales office contact any of the following:

North America:  
1 888 589 3662  
[americas@futurelightingsolutions.com](mailto:americas@futurelightingsolutions.com)

Europe:  
00 800 443 88 873  
[europe@futurelightingsolutions.com](mailto:europe@futurelightingsolutions.com)

Asia Pacific:  
800 5864 5337  
[asia@futurelightingsolutions.com](mailto:asia@futurelightingsolutions.com)

Japan:  
800 5864 5337  
[japan@futurelightingsolutions.com](mailto:japan@futurelightingsolutions.com)

©2011 Philips Lumileds Lighting Company. All rights reserved.  
Product specifications are subject to change without notice.  
LUXEON is a registered trademark of the Philips Lumileds Lighting Company in the United States and other countries.

**PHILIPS**  
**LUMILEDS**