



PARA LIGHT NANJING ELECTRONICS CO., LTD.

4F, No.1, Lane 93, Chien Yi Road, Chung Ho City, Taipei, Taiwan, R.O.C.

Tel: 886-2-2225-3733

Fax: 886-2-2225-4800

E-mail: para@para.com.tw

<http://www.para.com.tw>

DATA SHEET

PART NO. : L-C170KGCT-U1

REV : A / 0

CUSTOMER'S APPROVAL : _____

DCC : _____

DRAWING NO. : DS-72-07-0006

DATE : 2007-01-22

PAGE 1 of 14

● PACKAGE OUTLINE DIMENSIONS

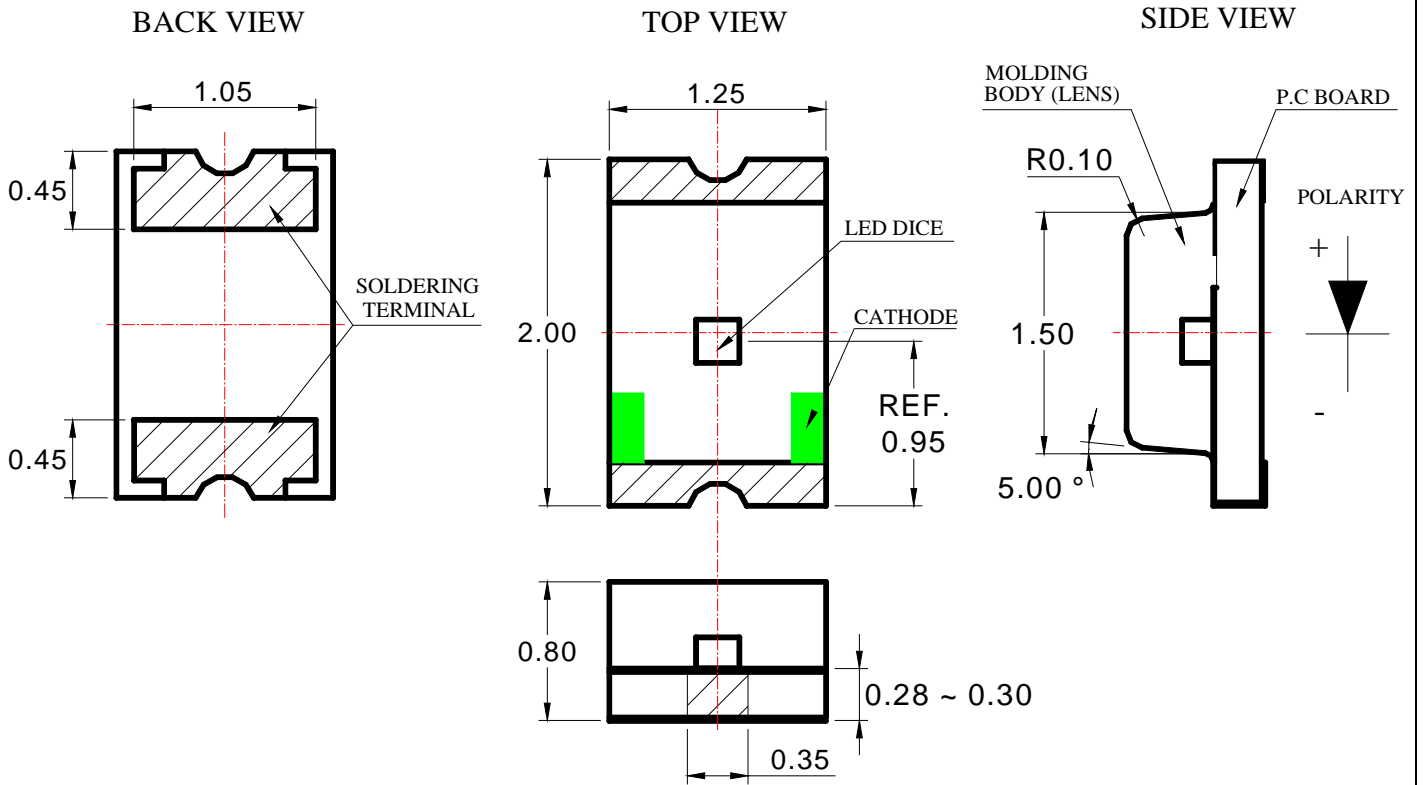

Notes:

1. All dimensions are in millimeters.
2. Tolerance is $\pm 0.1\text{mm}$ (.004") unless otherwise noted.

● Features

- * Top view, wide view angle, single color Chip LED.
- * Package in 8mm tape on 7" diameter reels.
- * Compatible with automatic Pick & Place equipment.
- * Compatible with Infrared and Wave soldering reflow solder processes.
- * EIA STD package.
- * I.C. compatible.
- * Pb free product.

● **Chip Materials**

- * Dice Material : AlInGaP
- * Light Color : Super Green
- * Lens Color : Water Clear

● **Absolute Maximum Ratings(Ta=25)**

| Symbol | Parameter | Rating | Unit |
|--------|--|----------------------|------|
| PD | Power Dissipation | 60 | mW |
| IPF | Peak Forward Current (1/10 Duty Cycle, 0.1ms Pulse Width) | 60 | mA |
| IF | Continuous Forward Current | 30 | mA |
| - | De-rating Linear From 25 | 0.25 | mA/ |
| VR | Reverse Voltage | 5 | V |
| ESD | Electrostatic Discharge Threshold(HBM) ^{Note A} | 2000 | V |
| Topr | Operating Temperature Range | -40 ~ +85 | |
| Tstg | Storage Temperature Range | -40 ~ +85 | |
| - | Wave Soldering Condition (Two times Max.) | 260 (for 5 seconds) | |
| - | Infrared Soldering Condition (Two times MAX.) | 240 (for 10 seconds) | |

Note A :

HBM : Human Body Model. Seller gives no other assurances regarding the ability of to withstand ESD.

● **Electro-Optical Characteristics(Ta=25)**

| Parameter | Symbol | Min. | Typ. | Max. | Unit | Test Condition |
|--------------------------|--------|------|------|------|------|-------------------|
| Luminous Intensity | IV | 16.0 | 30.0 | | mcd | IF=20mA |
| Viewing Angle | 2 1/2 | | 130 | | deg | Note 2 |
| Peak Emission Wavelength | p | | 571 | | nm | Measurement @Peak |
| Dominant Wavelength | d | | 570 | | nm | IF=20mA |
| Spectral Line Half-Width | | | 15 | | nm | |
| Forward Voltage | VF | | 2.05 | 2.4 | V | IF =20mA |
| Reverse Current | IR | | | 100 | μ A | VR = 5V |

Notes:

1. Luminous intensity is measured with a light sensor and filter combination that proximities the CIE eye-response curve.
2. $1/2$ is the off-axis angle at which the luminous intensity is half the axial luminous intensity.
3. The dominant wavelength λ_d is derived from the CIE chromaticity diagram and represents the single wavelength which defines the color of the device.
4. Caution in ESD :
Static Electricity and surge damages the LED. It is recommended use a wrist band or anti-electrostatic glove when handling the LED. All devices, equipment and machinery must be properly grounded.
5. Major standard testing equipment by "Instrument System" Model : CAS140B Compact Array Spectrometer and "KEITHLEY" Source Meter Model : 2400.

● Typical Electro-Optical Characteristics Curves

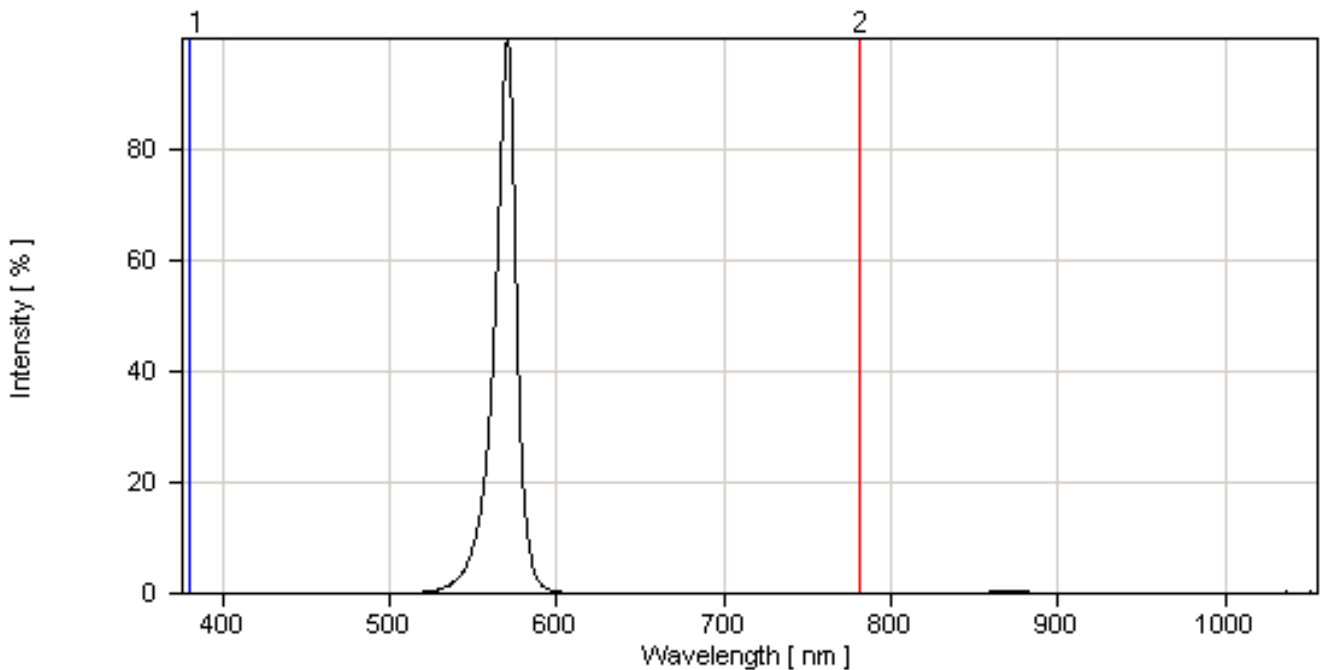

Fig.1 Relative Intensity vs. Wavelength

● Typical Electro-Optical Characteristics Curves

(25 Ambient Temperature Unless Otherwise Noted)

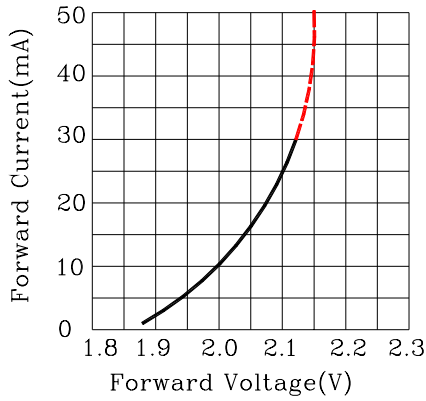

Fig.2 Forward Current vs. Forward Voltage

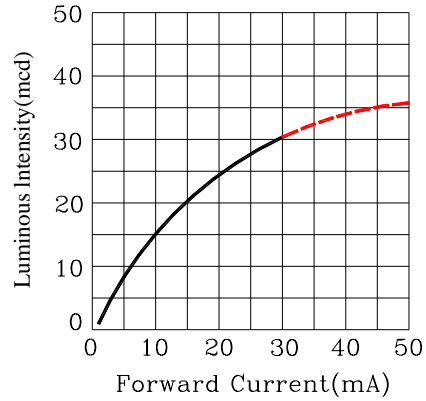

Fig.3 Luminous Intensity vs. Forward Current

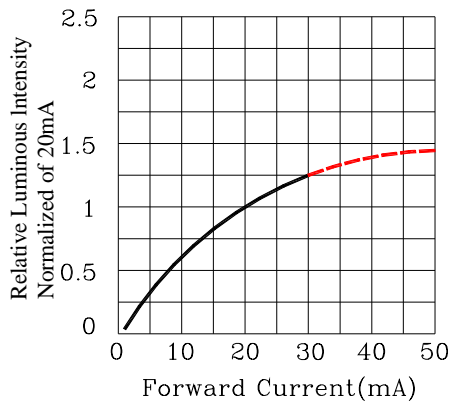

Fig.4 Relative Luminous Intensity vs. Forward Current

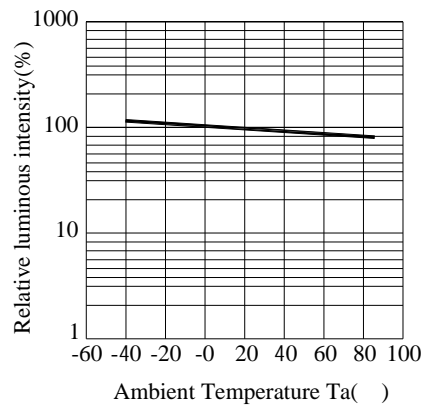

Fig.5 Luminous Intensity vs. Ambient Temperature

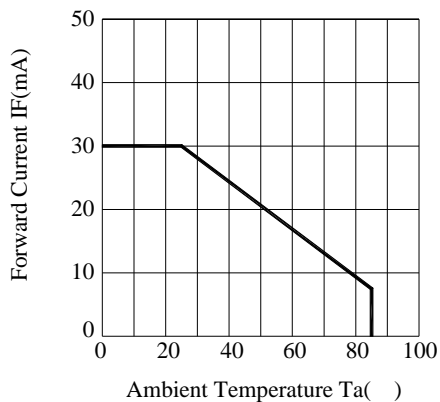

Fig.6 Forward Current Derating Curve

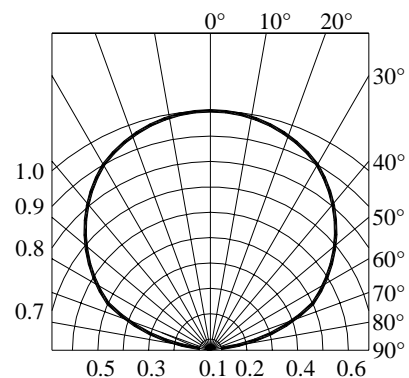

Fig.7 Relative Intensity vs. Angle

● Label Explanation



CUS. PART NO: To be denominated.

CUSTOMER: To be denominated.

PART NO: Refer to P14

BATCH: N5GA(actual code will be base on page 11 specification).

N--- Luminous Intensity Code

5--- Forward Voltage Code

GA--- Dominant Wavelength Code

LOT NO: E L S 4 7 0009
 A B C D E F

A---E: For series number

B---L: Local **F:** Foreign

C---S: SMD

D---Year

E---Month

F---SPEC.

QUANTITY: (Below are standard specification, actual packing quantity reference page 7)

3000pcs for 150、170、110、155、115 series

4000pcs for 191 series

5000pcs for 192 series

● Reel Dimensions

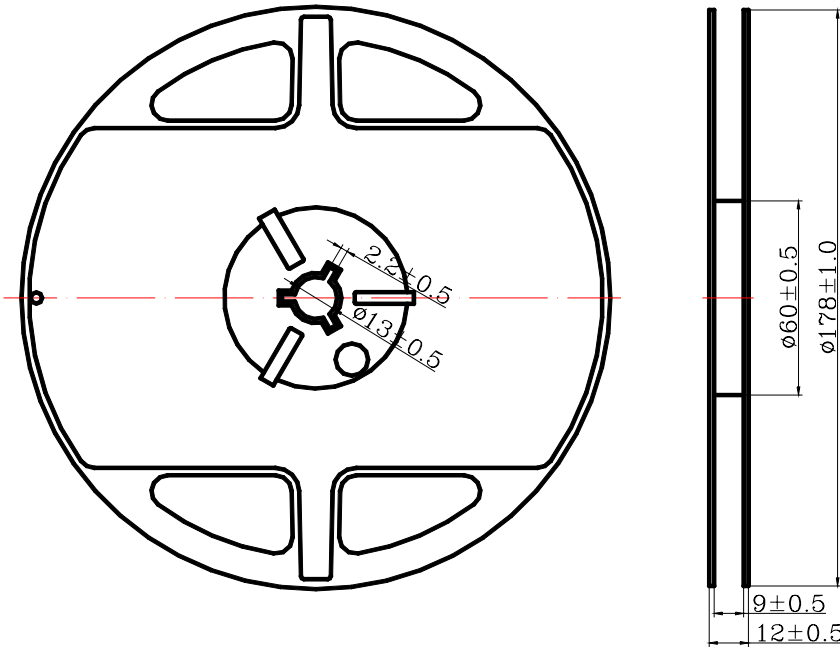

Notes:

1. Taping Quantity : 3000pcs
2. The tolerances unless mentioned is $\pm 0.1\text{mm}$, Angle $\pm 0.5^\circ$, Unit : mm.

● Package Dimensions Of Tape And Reel

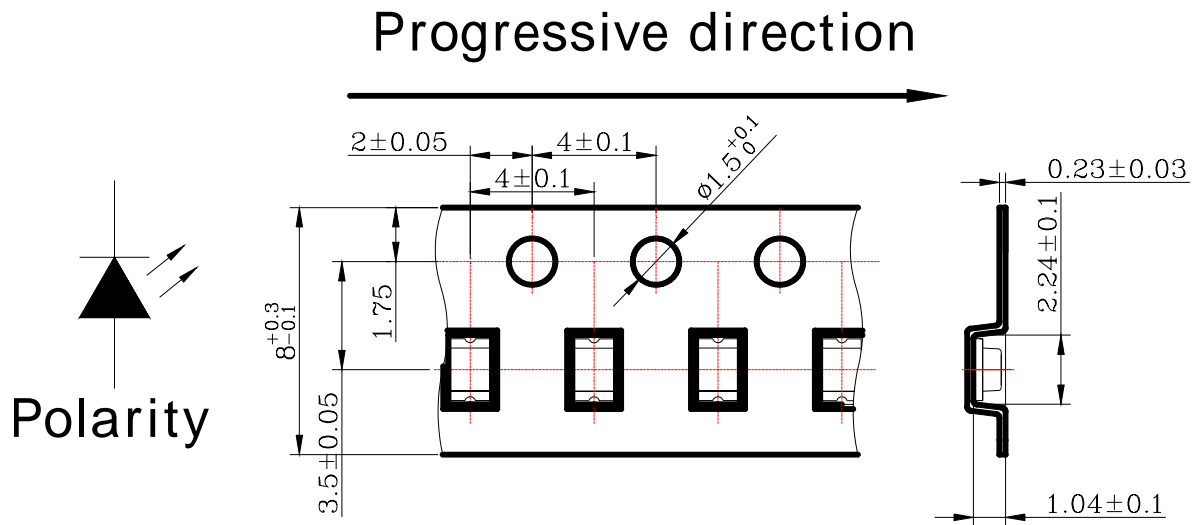

Notes: All dimensions are in millimeters.

Moisture Resistant Packaging

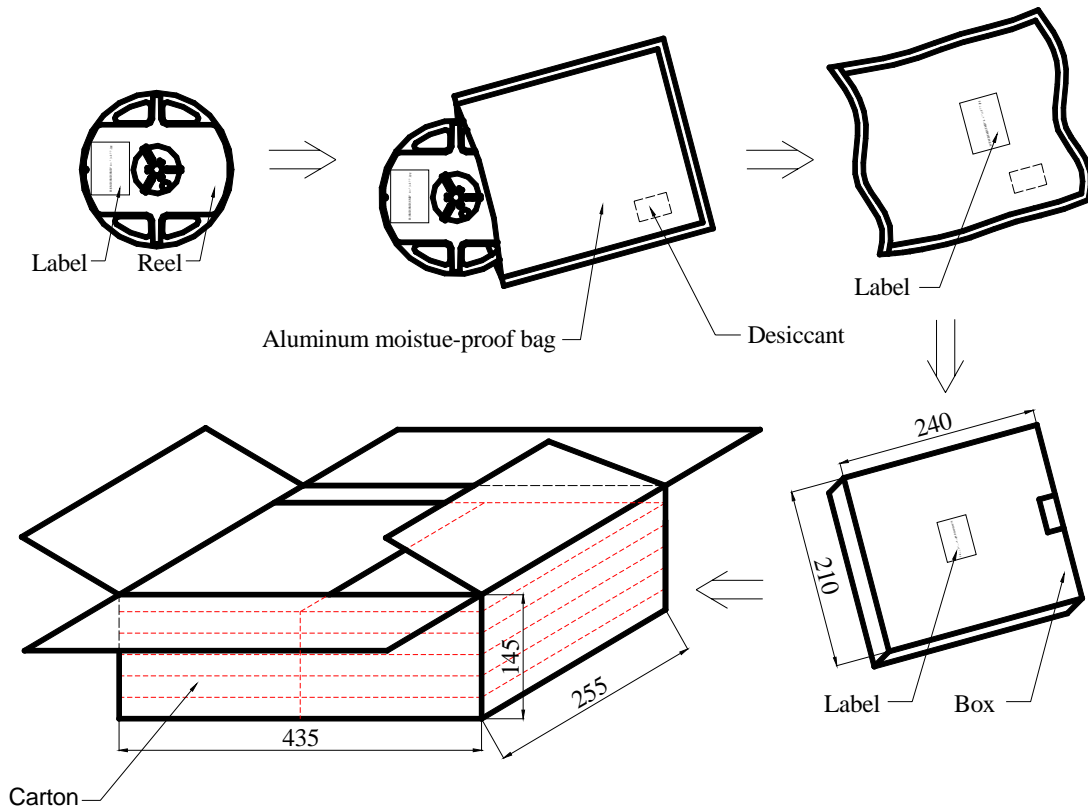

Notes : One reel in a bag, one bag in a inner box, ten inner boxes in a carton. Unit : mm.

● Cleaning

- * If cleaning is required , use the following solutions for less than 1 minute and less than 40 .
- * Appropriate chemicals: Ethyl alcohol and isopropyl alcohol.
- * Effect of ultrasonic cleaning on the LED resin body differs depending on such factors as the oscillator output, size of PCB and LED mounting method. The use of ultrasonic cleaning should be enforced at proper output after confirming there is no problem.

● Suggest Soldering Pad Dimensions

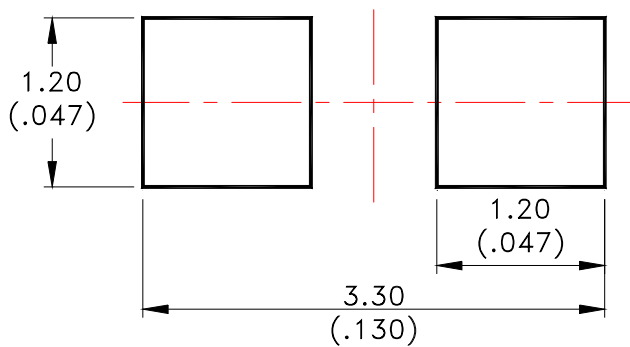

Direction of PWB camber
and go to reflow furnace

Suggest Sn/Pb IR Reflow Soldering Profile Condition:

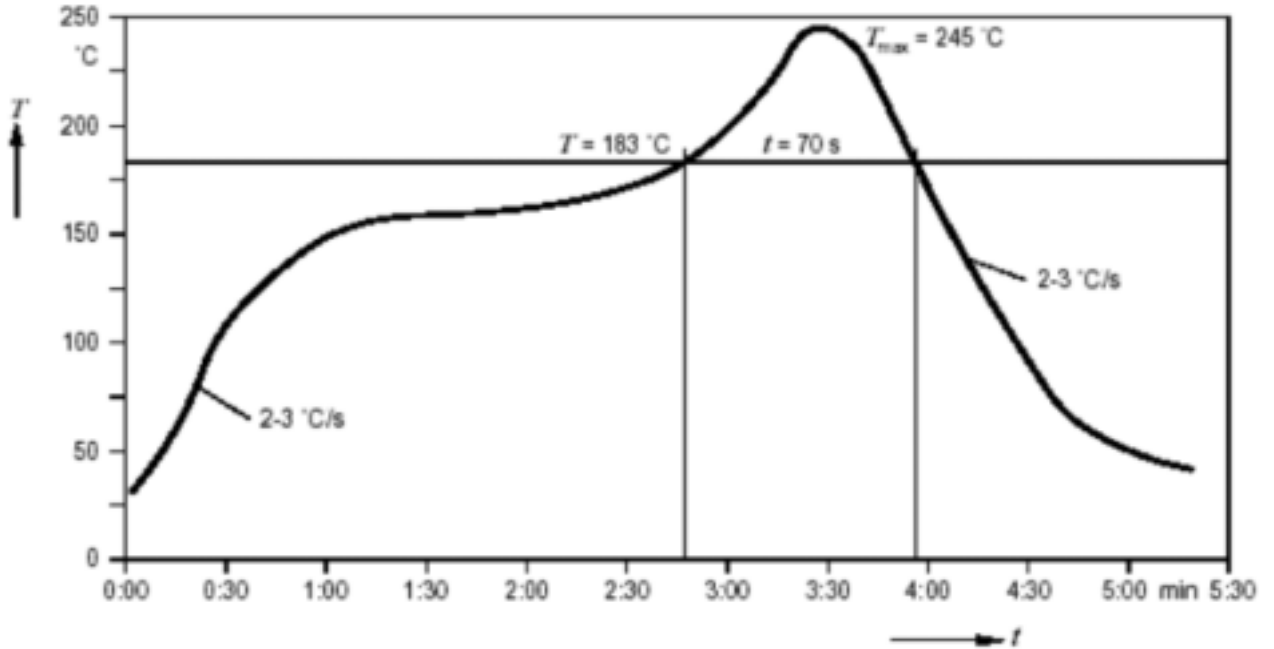

Suggest Pb-Free IR Reflow Soldering Profile Condition:

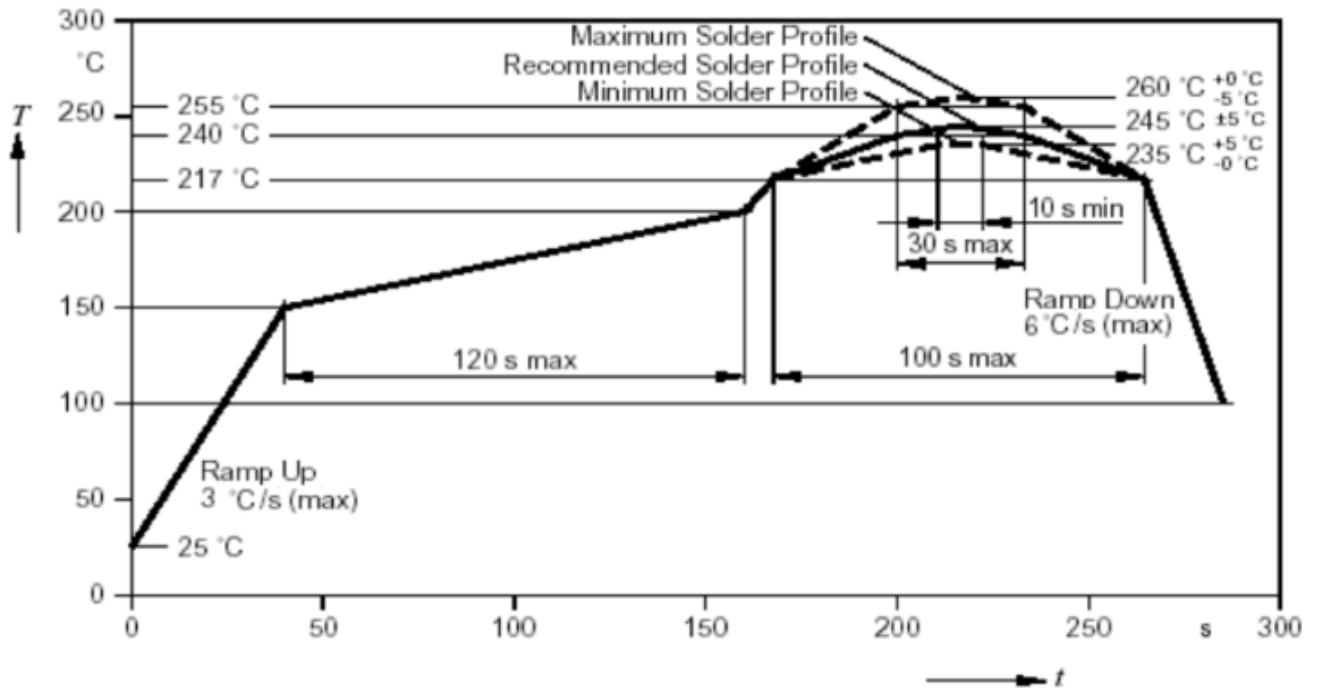



SURFACE MOUNT DEVICE LED

Part No. : L-C170KGCT-U1

REV:A / 0

● Bin Code List

| Luminous Intensity(IV), Unit:mcd@20mA | | |
|---------------------------------------|------|------|
| Bin Code | Min | Max |
| M | 18.0 | 28.0 |
| N | 28.0 | 45.0 |
| P | 45.0 | 71.0 |
| | | |

Tolerance of each bin are $\pm 15\%$

| Forward Voltage(VF), Unit:V@20mA | | |
|----------------------------------|------|------|
| Bin Code | Min | Max |
| 4 | 1.90 | 2.00 |
| 5 | 2.00 | 2.10 |
| 6 | 2.10 | 2.20 |
| 7 | 2.20 | 2.30 |

Tolerance of each bin are ± 0.1 Volt

| Dominant Wavelength (Hue),Unit: nm@20mA | | |
|---|-------|-------|
| Bin Code | Min | Max |
| GA | 567.0 | 570.0 |
| GB | 570.0 | 573.0 |
| GC | 573.0 | 576.0 |

Tolerance of each bin are ± 1 nm

● CAUTIONS

1.Application Limitation :

The LED's described here are intended to be used for ordinary electronic equipment (such as office equipment, communication equipment and household application).Consult PARA's sales in advance for information on application in which exceptional quality and reliability are required, particularly when the failure or malfunction of the LED's may directly jeopardize life or health (such as airplanes, automobiles, traffic control equipment, life support system and safety devices).

2.Storage :

Before opening the package :

The LEDs should be store kept at **5°C to 30°C** or less and 85%RH or less.

After opening the package :

The LEDs should be kept at **5°C to 30°C** or less and 70%RH or less. The LEDs should be soldered within 168 hours(7 days) after opening the package.

Please avoid rapid transitions in ambient temperature in high humidity environments where condensation may occur.

LEDs stored out of their original packaging for more than a week should be baked at 30 ° C for at 24 hours before solder assembly.

3.Soldering

Do not apply any stress to the lead frame during soldering while the LED is at high temperature.

Recommended soldering condition.

Reflow Soldering :

Pre-heat 120~150°C, 120sec. MAX., Peak temperature : 240°C Max. Soldering time : 10 sec Max.

Soldering Iron : (Not recommended)

Temperature 300°C Max., Soldering time : 3 sec. Max.(one time only), power dissipation of iron : 20W Max. use SN60 solder of solder with silver content and don't to touch LED lens when soldering.

Wave soldering :

Pre-heat 100°C Max, Pre-heat time 60 sec. Max, Solder wave 260°C Max, Soldering time 5 sec. Max. performed consecutively cooling process is required between 1st and 2nd soldering processes.

4. Lead-Free Soldering

For Reflow Soldering :

- 1、 Pre-Heat Temp:150-180 ,120sec.Max.
- 2、 Soldering Temp:Temperature Of Soldering Pot Over 230 ,40sec.Max.
- 3、 Peak Temperature:260 , 5sec.
- 4、 Reflow Repetition:2 Times Max.
- 5、 Suggest Solder Paste Formula 93.3 Sn/3.1 Ag/3.1 Bi /0.5 Cu

For Soldering Iron (Not Recommended) :

- 1、 Iron Tip Temp:350 Max.
- 2、 Soldering Iron:30w Max.
- 3、 Soldering Time:3 Sec. Max. One Time.

For Dip Soldering :

- 1、 Pre-Heat Temp:150 Max. 120 Sec. Max.
- 2、 Bath Temp:265 Max.
- 3、 Dip Time:5 Sec. Max.

5. Drive Method

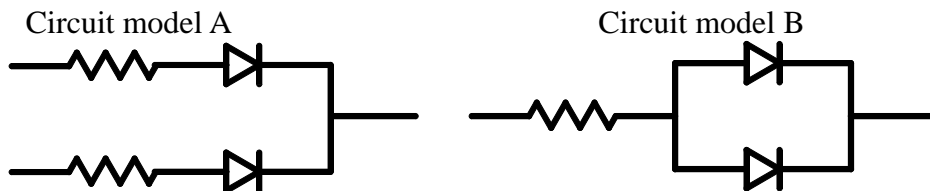

(A)Recommended circuit.

(B)The difference of brightness between LED`s could be found due to the Vf-If characteristics of LED.

6. Reliability Test

| Classification | Test Item | Test Condition | Reference Standard |
|--------------------|--|---|---|
| Endurance Test | Operation Life | Ta= Under Room Temperature As Per Data Sheet Maximum Rating *Test Time= 1000HRS (-24HRS,+72HRS)*@20mA. | MIL-STD-750D:1026 (1995) MIL-STD-883D:1005 (1991) JIS C 7021:B-1 (1982) |
| | High Temperature High Humidity Storage | IR-Reflow In-Board, 2 Times Ta= 65±5 ,RH= 90 ~ 95% *Test Time= 1000HRS±2HRS | MIL-STD-202F:103B(1980) JIS C 7021:B-11(1982) |
| | High Temperature Storage | Ta= 105±5 Test Time= 1000HRS (-24HRS,72HRS) | MIL-STD-883D:1008 (1991) JIS C 7021:B-10 (1982) |
| | Low Temperature Storage | Ta= -55±5 *Test Time=1000HRS (-24HRS,72HRS) | JIS C 7021:B-12 (1982) |
| Environmental Test | Temperature Cycling | 105±5 -55±5 10mins 10mins 100 Cycles | MIL-STD-202F:107D (1980) MIL-STD-750D:1051(1995) MIL-STD-883D:1010 (1991) JIS C 7021:A-4(1982) |
| | Thermal Shock | IR-Reflow In-Board, 2 Times 105±5 -55 ±5 10mins 10mins 100 Cycles | MIL-STD-202F:107D(1980) MIL-STD-750D:1051(1995) MIL-STD-883D:1011 (1991) |
| | Solder Resistance | Tsol= 260 ± 5 Dwell Time= 10 ± 1sec | MIL-STD-202F:210A(1980) MIL-STD-750D:2031(1995) JIS C 7021:A-1(1982) |
| | Solder ability | Tsol= 235 ± 5 Immersion time 2±0.5 sec Immersion rate 25±2.5 mm/sec Coverage 95% of the dipped surface | MIL-STD-202F:208D(1980) MIL-STD-750D:2026(1995) MIL-STD-883D:2003(1991) IEC 68 Part 2-20 JIS C 7021:A-2(1982) |

7. Others:

The appearance and specifications of the product may be modified for improvement without notice.

DRAWING NO. : DS-72-07-0006

DATE : 2007-01-22

PAGE 13 of 14

PARA-FOR-068

| | | |
|---|--------------------------|-----------|
|  | SURFACE MOUNT DEVICE LED | |
| | Part No. : L-C170KGCT-U1 | REV:A / 0 |

● PART NO. SYSTEM :

L - C 1 7 0 X C X X - X X X X

XXXX : Special specification for customer

T : Taping for 7 inch reel
TC : Taping for 13 inch reel
TH : IV half binning
TP : Wavelength binning

Lens color
C : Water Clear
W : White Diffused
T : Color Transparent
D : Color Diffused

G : Gap 570nm Green
Y : GaAsp 585 nm Yellow
E : GaAsp 620 nm Orange
SR : GaAlAs 634 nm Red
KG : AlInGap 570nm Super Green
KY : AlInGap 590nm Super Yellow
KF : AlInGap 605nm Super Amber
KR : AlInGap 630 nm Super Red
LB : InGaN 470nm Blue
LG : InGaN 525nm Green

0 : Single chip
1/2 : Super thin single chip
5/6 : Dual chip
F : Three chip(Full color)

150 : 1206 1.1T Type
170 : 0805 0.8T Type
191 : 0603 0.6T Type
192 : 0603 0.4T Type
110 : 1206 1.0T Type

C : Top View Type
S : Side View Type