

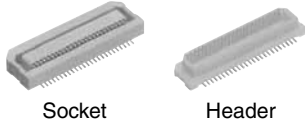

TOUGH CONTACT

• P5K



Socket

Header

• P5KS

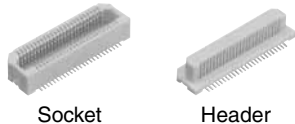

Socket

Header

Note: The external appearance and PC board pattern differs for the P5K and P5KS series.

Compliance with RoHS Directive

FEATURES

1. The product lineup consists of 3.0 mm, 3.5 mm, 4.0 mm, 4.5 mm, 5.0 mm, 5.5 mm, 6.0 mm, 6.5 mm, 7.0 mm, 8.0 mm, and 9.0 mm.

Type	Mated height	Notes
P5K	3 mm, 3.5 mm	The external appearance and PC board pattern differs for the P5K and P5KS series.
P5KS	4 mm, 4.5 mm, 5 mm, 5.5 mm, 6 mm, 6.5 mm, 7 mm, 8 mm, 9 mm	

2. Strong resistance to adverse environments! Utilizes **TOUGH CONTACT** construction for high contact reliability. (See Page 6 for details of the structure)
3. Even with the low profile, the effective mating length has been extended to ensure that there is some latitude in the mating.

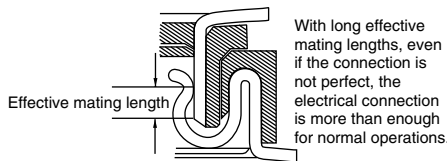

With long effective mating lengths, even if the connection is not perfect, the electrical connection is more than enough for normal operations.

Type	Effective mating length
P5K	0.65 mm
P5KS	1.0 mm

4. Automatic mounting

1) Suction area for suction-type automatic mounting machines is employed.

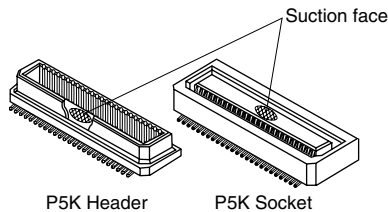

P5K Header

P5K Socket

APPLICATIONS

1. Compact portable devices “Cellular phones, DVC, Digital cameras, etc”
2. The 160-contacts connector: This connector is particularly suited to the motherboard, CPU board, and other multi-pin expansion boards on notebook PCs and other info-communications applications.

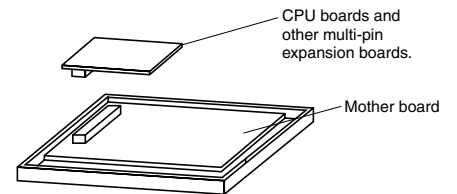

ORDERING INFORMATION

1. P5K (3.0 mm and 3.5 mm)

AXK [] [] [] [] 7 Y G

5: Narrow Pitch Connector P5K Socket

6: Narrow Pitch Connector P5K Header

Number of contacts (2 digits)

Mated height

<Socket>

1: For mated height 3.0 mm and 3.5 mm

<Header>

2: For mated height 3.5 mm

3: For mated height 3.0 mm

Functions

3: With positioning bosses

4: Without positioning bosses

Surface treatment (Contact portion / Terminal portion)

7: Ni plating on base, Au plating on surface /

Ni plating on base, Au plating on surface (Ni barrier product)

Contact portion

<Socket> Y: V notch type product

<Header> Y: V notch type product

Packing

G: 1,500 pieces embossed tape and plastic reel × 2

AXK(5(S)/6(S))

2. P5KS (4.0 mm, 4.5 mm, 5.0 mm, 5.5 mm, 6.0 mm, 6.5 mm, 7.0 mm, 8.0 mm and 9.0 mm)

	AXK	□	□	□	□	□	7	Y	G
5S: Narrow Pitch Connector P5KS Socket 6S: Narrow Pitch Connector P5KS Header									
Number of contacts (2 digits)									
Mated height <Socket> 0: For mated height 4.0 mm, 5.0 mm and 6.0 mm 2: For mated height 4.5 mm, 5.5 mm and 6.5 mm 3: For mated height 7.0 mm, 8.0 mm and 9.0 mm <Header> 4: For mated height 4.0 mm, 4.5 mm and 7.0 mm 5: For mated height 5.0 mm, 5.5 mm and 8.0 mm 6: For mated height 6.0 mm, 6.5 mm and 9.0 mm									
Functions 3: With positioning boss and direction for protection from reverse mating 4: Without positioning boss/with direction for protection from reverse mating 7: With positioning boss/without direction for protection from reverse mating 8: Without positioning boss and direction for protection from reverse mating									
Surface treatment (Contact portion / Terminal portion) 7: Ni plating on base, Au plating on surface / Ni plating on base, Au plating on surface (Ni barrier product)									
Contact portion <Socket> Y: V notch type product <Header> Y: V notch type product									
Packing G: 1,500 pieces embossed tape and plastic reel × 2 (Socket: Mated heights 4.0 mm, 4.5 mm, 5.0 mm, 5.5 mm, 6.0 mm, 6.5 mm) (Header: Mated heights 4.0 mm, 4.5 mm, 7.0 mm) 1,000 pieces plastic reel × 2 (Socket: Mated heights 7.0 mm, 8.0 mm, 9.0 mm) (Header: Mated heights 5.0 mm, 5.5 mm, 6.0 mm, 6.5 mm, 8.0 mm, 9.0 mm)									

Note: Models with mating directionality to prevent reverse insertion have less than 100 contacts. Models without mating directionality to prevent reverse insertion have over 100 contacts.

PRODUCT TYPES

1. P5K

Product name	Mated height	No. of contacts	Part No.		Packing		
			Socket	Header	Inner carton (1 reel)	Outer carton	
			TOUGH CONTACT	TOUGH CONTACT			
P5K	3.0 mm	20	AXK520147YG	AXK620347YG	1,500 pieces	3,000 pieces	
		22	AXK522147YG	AXK622347YG			
		30	AXK530147YG	AXK630347YG			
		40	AXK540147YG	AXK640347YG			
		50	AXK550147YG	AXK650347YG			
		60	AXK560147YG	AXK660347YG			
		70	AXK570147YG	AXK670347YG			
		80	AXK580147YG	AXK680347YG			
		100	AXK500147YG	AXK600347YG			
		120	AXK5A2147YG	AXK6A2347YG			
		3.5 mm	20	AXK520147YG			AXK620247YG
			22	AXK522147YG			AXK622247YG
	30		AXK530147YG	AXK630247YG			
	34		AXK534147YG	AXK634247YG			
	40		AXK540147YG	AXK640247YG			
	50		AXK550147YG	AXK650247YG			
	60		AXK560147YG	AXK660247YG			
	70		AXK570147YG	AXK670247YG			
	80		AXK580147YG	AXK680247YG			
	100		AXK500147YG	AXK600247YG			
	120		AXK5A2147YG	AXK6A2247YG			

- Notes: 1. Regarding ordering units: During production: Please make orders in 1 reel units.
Samples for mounting confirmation: Available in units of 50 pieces. Please consult us. (See "Regarding sample orders to confirm proper mounting" on page 19.)
Samples: Small lot orders are possible.
2. The standard type comes without positioning bosses.
Connectors with positioning bosses are available on-demand production. For P5K type of 8th digit of the part no. changes from 4 to 3.
e.g. Mated height 3.0 mm, 20 contacts for sockets: AXK520137YG
3. Previous non-**TOUGH CONTACT** types and current **TOUGH CONTACT** types are compatible for mating.

2. P5KS

Product name	Mated height	No. of contacts	Part No.		Packing	
			Socket	Header	Inner carton (1 reel)	Outer carton
			<i>TOUGH CONTACT</i>	<i>TOUGH CONTACT</i>		
P5KS	4.0 mm	20	AXK5S20047YG	AXK6S20447YG	1,500 pieces	3,000 pieces
		24	AXK5S24047YG	AXK6S24447YG		
		30	AXK5S30047YG	AXK6S30447YG		
		34	AXK5S34047YG	AXK6S34447YG		
		40	AXK5S40047YG	AXK6S40447YG		
		50	AXK5S50047YG	AXK6S50447YG		
		60	AXK5S60047YG	AXK6S60447YG		
		70	AXK5S70047YG	AXK6S70447YG		
		80	AXK5S80047YG	AXK6S80447YG		
		100	AXK5S00047YG	AXK6S00447YG		
	120	AXK5SA2077YG	AXK6SA2477YG			
	160	AXK5SA6077YG	AXK6SA6477YG			
	4.5 mm	20	AXK5S20247YG	AXK6S20447YG		
		24	AXK5S24247YG	AXK6S24447YG		
		30	AXK5S30247YG	AXK6S30447YG		
		34	AXK5S34247YG	AXK6S34447YG		
		36	AXK5S36247YG	AXK6S36447YG		
		40	AXK5S40247YG	AXK6S40447YG		
		50	AXK5S50247YG	AXK6S50447YG		
		60	AXK5S60247YG	AXK6S60447YG		
70		AXK5S70247YG	AXK6S70447YG			
80		AXK5S80247YG	AXK6S80447YG			
P5KS	5.0 mm	20	AXK5S20047YG	AXK6S20547YG	Socket: 1,500 pieces Header: 1,000 pieces	Socket: 3,000 pieces Header: 2,000 pieces
		24	AXK5S24047YG	AXK6S24547YG		
		30	AXK5S30047YG	AXK6S30547YG		
		34	AXK5S34047YG	AXK6S34547YG		
		40	AXK5S40047YG	AXK6S40547YG		
		50	AXK5S50047YG	AXK6S50547YG		
		60	AXK5S60047YG	AXK6S60547YG		
		70	AXK5S70047YG	AXK6S70547YG		
		80	AXK5S80047YG	AXK6S80547YG		
		100	AXK5S00047YG	AXK6S00547YG		
	5.5 mm	20	AXK5S20247YG	AXK6S20547YG		
		24	AXK5S24247YG	AXK6S24547YG		
		30	AXK5S30247YG	AXK6S30547YG		
		34	AXK5S34247YG	AXK6S34547YG		
		40	AXK5S40247YG	AXK6S40547YG		
		50	AXK5S50247YG	AXK6S50547YG		
		60	AXK5S60247YG	AXK6S60547YG		
		70	AXK5S70247YG	AXK6S70547YG		
		80	AXK5S80247YG	AXK6S80547YG		
		100	AXK5S00247YG	AXK6S00547YG		
6.0 mm	20	AXK5S20047YG	AXK6S20647YG			
	30	AXK5S30047YG	AXK6S30647YG			
	40	AXK5S40047YG	AXK6S40647YG			
	50	AXK5S50047YG	AXK6S50647YG			
	60	AXK5S60047YG	AXK6S60647YG			
	70	AXK5S70047YG	AXK6S70647YG			
	80	AXK5S80047YG	AXK6S80647YG			
	100	AXK5S00047YG	AXK6S00647YG			
6.5 mm	20	AXK5S20247YG	AXK6S20647YG			
	30	AXK5S30247YG	AXK6S30647YG			
	40	AXK5S40247YG	AXK6S40647YG			
	50	AXK5S50247YG	AXK6S50647YG			
	60	AXK5S60247YG	AXK6S60647YG			
	70	AXK5S70247YG	AXK6S70647YG			
	80	AXK5S80247YG	AXK6S80647YG			
100	AXK5S00247YG	AXK6S00647YG				
		130	AXK5SA3277YG	AXK6SA3677YG		

AXK(5(S)/6(S))

Product name	Mated height	No. of contacts	Part No.		Packing	
			Socket	Header	Inner carton (1 reel)	Outer carton
			TOUGH CONTACT	TOUGH CONTACT		
P5KS	7.0 mm	20	AXK5S20347YG	AXK6S20447YG	Socket: 1,000 pieces Header: 1,500 pieces	Socket: 2,000 pieces Header: 3,000 pieces
		30	AXK5S30347YG	AXK6S30447YG		
		40	AXK5S40347YG	AXK6S40447YG		
		50	AXK5S50347YG	AXK6S50447YG		
		60	AXK5S60347YG	AXK6S60447YG		
		70	AXK5S70347YG	AXK6S70447YG		
		80	AXK5S80347YG	AXK6S80447YG		
	100	AXK5S00347YG	AXK6S00447YG			
	8.0 mm	20	AXK5S20347YG	AXK6S20547YG	1,000 pieces	2,000 pieces
		30	AXK5S30347YG	AXK6S30547YG		
		40	AXK5S40347YG	AXK6S40547YG		
		50	AXK5S50347YG	AXK6S50547YG		
		60	AXK5S60347YG	AXK6S60547YG		
		70	AXK5S70347YG	AXK6S70547YG		
		80	AXK5S80347YG	AXK6S80547YG		
	100	AXK5S00347YG	AXK6S00547YG			
	9.0 mm	20	AXK5S20347YG	AXK6S20647YG	1,000 pieces	2,000 pieces
		30	AXK5S30347YG	AXK6S30647YG		
		40	AXK5S40347YG	AXK6S40647YG		
		50	AXK5S50347YG	AXK6S50647YG		
		60	AXK5S60347YG	AXK6S60647YG		
		70	AXK5S70347YG	AXK6S70647YG		
		80	AXK5S80347YG	AXK6S80647YG		
	100	AXK5S00347YG	AXK6S00647YG			

Notes: 1. Regarding ordering units: During production: Please make orders in 1 reel units.

Samples for mounting confirmation: Available in units of 50 pieces. Please consult us. (See "Regarding sample orders to confirm proper mounting" on page 19.)

Samples: Small lot orders are possible.

- The standard type comes without positioning bosses (However, mated heights of 4 mm or higher and 120 pins or more comes standard with bosses). Connectors with positioning bosses are available for on-demand production. For P5KS type of 9th digit of the part no. changes from 4 to 3.
e.g. Mated height 4.0 mm, 20 contacts for sockets: AXK5S20037YG
- Previous non-**TOUGH CONTACT** types and current **TOUGH CONTACT** types are compatible for mating.

SPECIFICATIONS

1. Characteristics

Item	Specifications			Conditions
	3mm, 3.5mm type	4mm, 4.5mm, 5mm, 5.5mm, 6mm, 6.5mm type	7mm, 8mm, 9mm type	
Electrical characteristics	Rated current	0.5A/terminal (Max. 10A)	0.5A/terminal (Max. 16A)	
	Rated voltage	60V AC/DC		
	Breakdown voltage	150V AC for 1 min.		Detection current: 1mA
	Insulation resistance	Min. 1000MΩ		Using 500V DC megger
	Contact resistance	Max. 60mΩ	Max. 80mΩ	Based on the contact resistance measurement method specified by JIS C 5402.
Mechanical characteristics	Composite insertion force	Max. 0.785N {80gf} × no. of contacts (initial)		
	Composite removal force	Min. 0.0588N {6gf} × no. of contacts		
	Contact holding force	Min. 0.98N {100gf}/contacts		Measuring the maximum force. As the contact is axially pull out.
Environmental characteristics	Ambient temperature	-55°C to +85°C		No freezing at low temperatures
	Soldering heat resistance	Max. peak temperature of 260°C (on the surface of the PC board around the connector terminals)		Infrared reflow soldering
		300°C within 5 sec., 350°C within 3 sec.		Soldering iron
	Thermal shock resistance (header and socket mated)	5 cycles, insulation resistance min. 100MΩ, contact resistance max. 60mΩ	5 cycles, insulation resistance min. 100MΩ, contact resistance max. 80mΩ	Sequence 1. -55 [±] 3°C, 30 minutes 2. ~, Max. 5 minutes 3. 85 [±] 3°C, 30 minutes 4. ~, Max. 5 minutes
	Humidity resistance (header and socket mated)	120 hours, insulation resistance min. 100MΩ, contact resistance max. 60mΩ	120 hours, insulation resistance min. 100MΩ, contact resistance max. 80mΩ	Bath temperature 40±2°C, humidity 90 to 95% R.H.
	Saltwater spray resistance (header and socket mated)	24 hours, insulation resistance min. 100MΩ, contact resistance max. 60mΩ	24 hours, insulation resistance min. 100MΩ, contact resistance max. 80mΩ	Bath temperature 35±2°C, saltwater concentration 5±1%
H ₂ S resistance (header and socket mated)	48 hours, contact resistance max. 60mΩ	48 hours, contact resistance max. 80mΩ	Bath temperature 40±2°C, gas concentration 3±1 ppm, humidity 75 to 80% R.H.	
Lifetime characteristics	Insertion and removal life	50 times		Repeated insertion and removal speed of max. 200 times/hours
Unit weight	P5K 3mm 30 contacts P5KS 4mm 30 contacts	Socket: 0.17g Header: 0.09g Socket: 0.18g Header: 0.16g		

2. Material and surface treatment

Part name	Mated height 3mm, 3.5mm, 4mm, 4.5mm, 5mm, 5.5mm, 6mm, 6.5mm, 7mm, 8mm, 9mm	
	Material	Surface treatment
Molded portion	Heat-resistant resin (UL94V-0)	—
Contact/post	Copper alloy	Contact portion: Ni plating on base, Au plating on surface Terminal portion: Ni plating on base, Au plating on surface (Except for thick of terminal) The section close to the soldering portion has a nickel barrier. (The nickel base is exposed.)

DIMENSIONS (Unit: mm) The CAD data of the products with a **CAD Data** mark can be downloaded from: <http://panasonic-electric-works.net/ac>

P5K: Mated height 3mm, 3.5mm type

- Socket

CAD Data

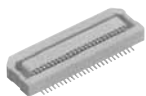

Dimension table (mm)

No. of contacts	A	B
20	8.20	4.50
22	8.70	5.00
30	10.70	7.00
34	11.70	8.00
40	13.20	9.50
50	15.70	12.00
60	18.20	14.50
70	20.70	17.00
80	23.20	19.50
100	28.20	24.50
120	33.20	29.50

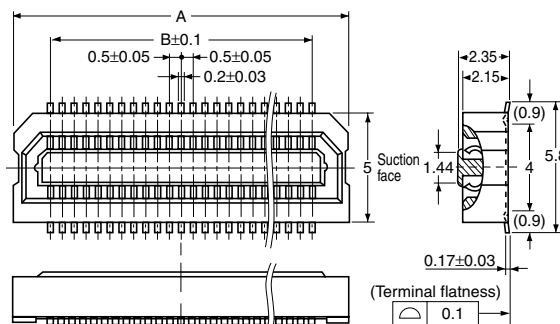

General tolerance: ±0.2

AXK(5(S)/6(S))

• Header

CAD Data



Dimension table (mm)

No. of contacts	A	B
20	8.20	4.50
22	8.70	5.00
30	10.70	7.00
34	11.70	8.00
40	13.20	9.50
50	15.70	12.00
60	18.20	14.50
70	20.70	17.00
80	23.20	19.50
100	28.20	24.50
120	33.20	29.50

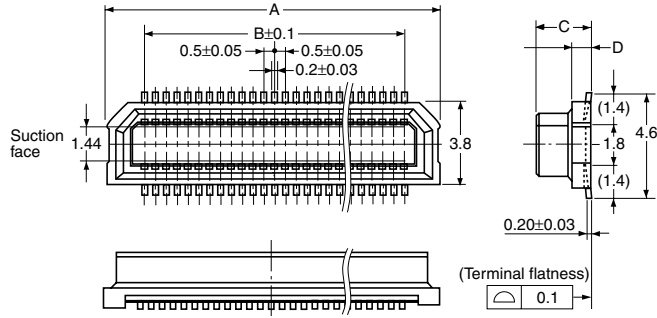

General tolerance: ±0.2

Mated height	C	D
3.0 mm	2.4	0.85
3.5 mm	2.9	1.35

• Socket and header are mated

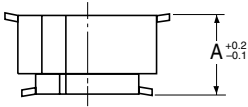

Mated height	A
3.0 mm	3.0
3.5 mm	3.5

Note) P5KS series (mated heights 4.0mm, 4.5mm, 5.0mm, 5.5mm, 6.0mm, 6.5mm, 7.0mm, 8.0mm, and 9.0mm) cannot be mated to this type.

P5KS: Mated height 4.0mm, 4.5mm, 5.0mm, 5.5mm, 6.0mm, 6.5mm, 7.0mm, 8.0mm, 9.0mm type

• Socket

CAD Data

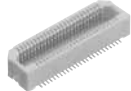

Dimension table (mm)

No. of contacts	A	B
20	8.20	4.50
24	9.20	5.50
30	10.70	7.00
34	11.70	8.00
36	12.20	8.50
40	13.20	9.50
50	15.70	12.00
60	18.20	14.50
70	20.70	17.00
80	23.20	19.50
100	28.20	24.50

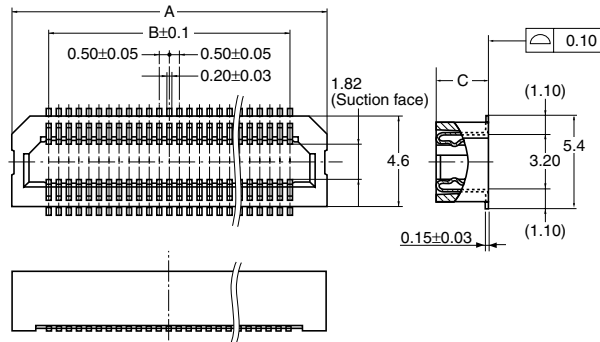

General tolerance: ±0.2

Mated height	C
4.0 mm, 5.0 mm, 6.0 mm	3.05
4.5 mm, 5.5 mm, 6.5 mm	3.55
7.0 mm, 8.0 mm, 9.0 mm	6.05

• Header

CAD Data



Dimension table (mm)

No. of contacts	A	B
20	8.20	4.50
24	9.20	5.50
30	10.70	7.00
34	11.70	8.00
36	12.20	8.50
40	13.20	9.50
50	15.70	12.00
60	18.20	14.50
70	20.70	17.00
80	23.20	19.50
100	28.20	24.50

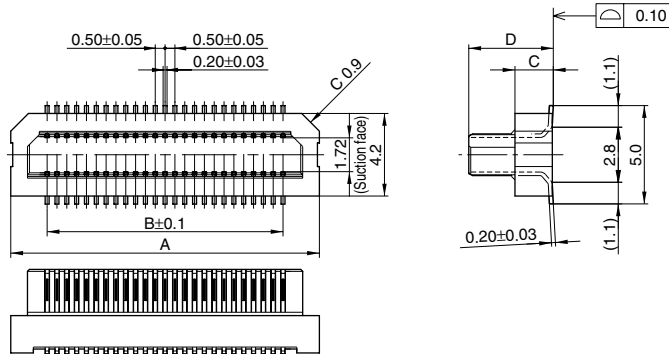

General tolerance: ±0.2

Mated height	C	D
4.0 mm, 4.5 mm, 7.0 mm	0.95	3.3
5.0 mm, 5.5 mm, 8.0 mm	1.95	4.3
6.0 mm, 6.5 mm, 9.0 mm	2.95	5.3

• Socket and header are mated

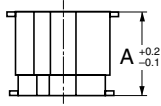

Mated height	A
4.0 mm	4.0
4.5 mm	4.5
5.0 mm	5.0
5.5 mm	5.5
6.0 mm	6.0
6.5 mm	6.5
7.0 mm	7.0
8.0 mm	8.0
9.0 mm	9.0

Note) P5K series (mated heights 3.0mm, 3.5mm) cannot be mated to this type.

P5KS: Mated height 4.0mm, 4.5mm for 120 contacts and 160 contacts types, 6.5mm for 130 contacts type

• Socket

CAD Data



No. of contacts	A	B	C
120	32.50	29.50	32.00
130	35.00	32.00	34.50
160	42.50	39.50	42.00

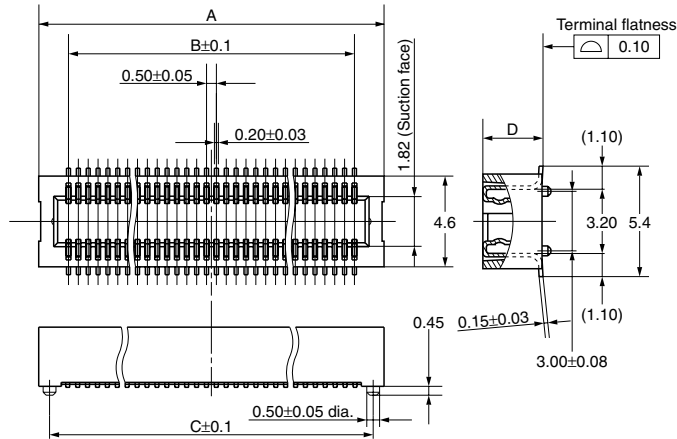

General tolerance: ±0.2

Mated height	D
4.0 mm	3.05
4.5 mm, 6.5 mm	3.55

• Header

CAD Data



No. of contacts	A	B	C
120	32.50	29.50	31.00
130	35.00	32.00	33.50
160	42.50	39.50	41.00

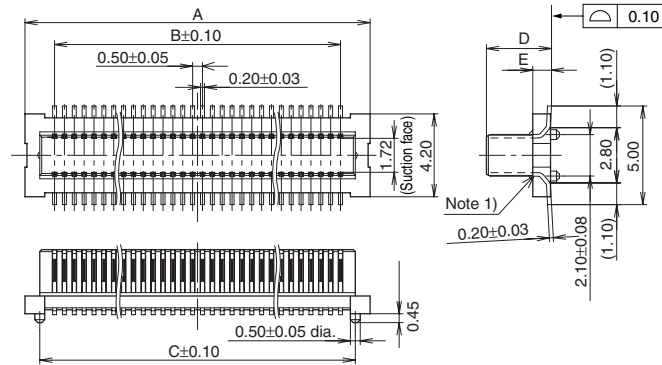

General tolerance: ±0.2

Mated height	D	E
4.0 mm, 4.5 mm	3.30	0.95
6.5 mm	5.30	2.95

• Socket and header are mated

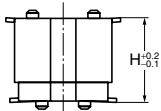

Mated height	H
4.0 mm	4.0
4.5 mm	4.5
6.5 mm	6.5

Notes) 1. Inquiry separately for diagrams of the embossed tape and cautions for use.
2. Be sure to ask for proper specifications and drawings before actual use.

AXK(5(S)/6(S))

EMBOSSED TAPE DIMENSIONS (unit: mm, Common for respective contact type, socket and header)

• Tape dimensions (Conforming to JIS C 0806-1990.

• Plastic reel dimensions (Conforming to EIAJ ET-7200B)

However, some tapes have mounting hole pitches that do not comply with the standard.)

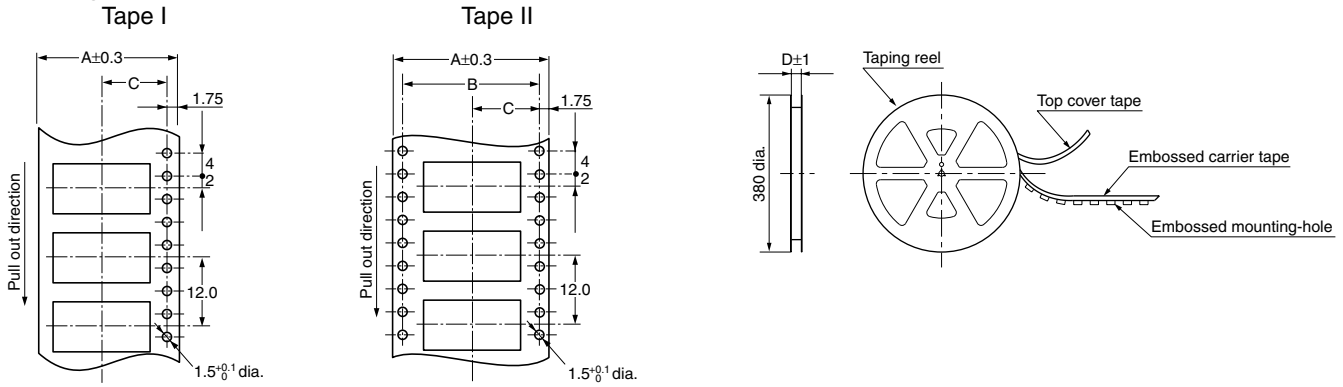

Dimension table (mm)

Suffix: G (1 reel, 1,500 pieces or 1,000 pieces embossed tape and plastic reel package)

Type	Mated height	No. of contacts	Type of taping	A	B	C	D	Quantity per reel
P5K	Socket and header are common 3.0mm, 3.5mm	20 to 50	Tape I	24.0	—	11.5	25.4	1,500 pcs.
		60 to 70	Tape II	32.0	28.4	14.2	33.4	
		80 to 100	Tape II	44.0	40.4	20.2	45.4	
		120	Tape II	56.0	52.4	26.2	57.4	
P5KS	Socket: 4.0mm, 4.5mm, 5.0mm, 5.5mm, 6.0mm, 6.5mm Header: 4.0mm, 4.5mm, 7.0mm	20 to 50	Tape I	24.0	—	11.5	25.4	1,500 pcs.
		60 to 70	Tape II	32.0	28.4	14.2	33.4	
		80 to 100	Tape II	44.0	40.4	20.2	45.4	
		120 to 160	Tape II	56.0	52.4	26.2	57.4	
	Socket: 7.0mm, 8.0mm, 9.0mm Header: 5.0mm, 5.5mm, 6.0mm, 6.5mm, 8.0mm, 9.0mm	20 to 50	Tape I	24.0	—	11.5	25.4	1,000 pcs.
		60 to 70	Tape II	32.0	28.4	14.2	33.4	
		80 to 100	Tape II	44.0	40.4	20.2	45.4	
		130	Tape II	56.0	52.4	26.2	57.4	

Connector orientation with respect to direction of progress of embossed tape

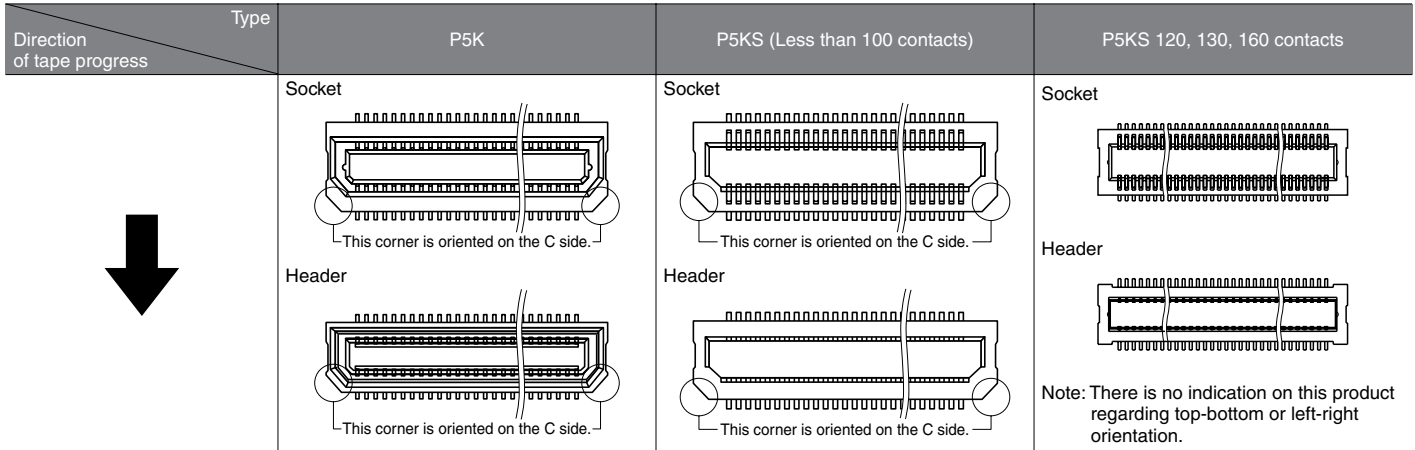

NOTES

1. Prevention of reverse mating

Other than P5KS series 120, 130, 160 contacts type, the socket and header are protected from reverse mating by a molded resin key. Excessive mating force may damage the key, so be sure to match chamfered corners when mating.

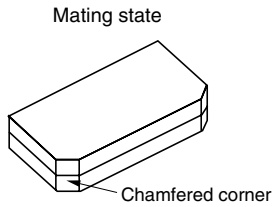
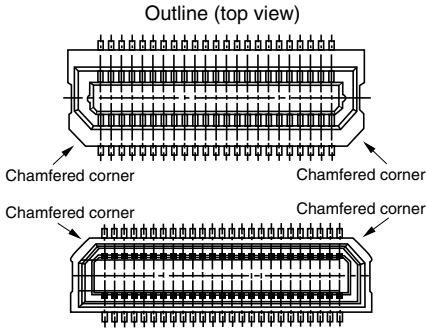

2. PC Boards and Recommended Metal Mask Patterns

Connectors are mounted with high density, with a pitch interval of 0.4 to 0.5 mm. It is therefore necessary to make sure that the right levels of solder are used, in order to reduce solder bridge and other issues. The figures to the right are recommended metal mask patterns. Please use them as a reference.

• P5K Socket

Recommended PC board pattern (TOP VIEW)

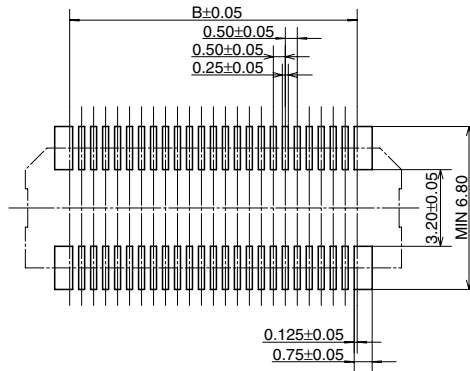

Recommended metal mask pattern
Metal mask thickness: Here, 150 μm
(Opening area ratio: 56%)

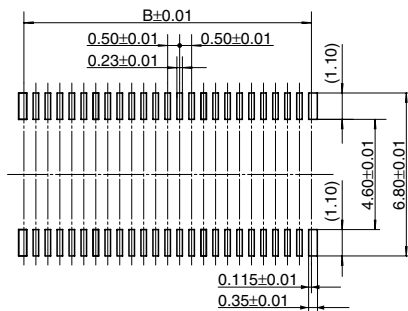

Recommended metal mask pattern
Metal mask thickness: Here, 120 μm
(Opening area ratio: 69%)

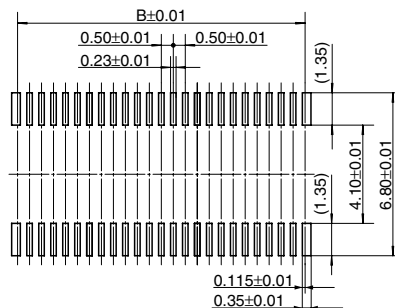

• P5K Header

Recommended PC board pattern (TOP VIEW)

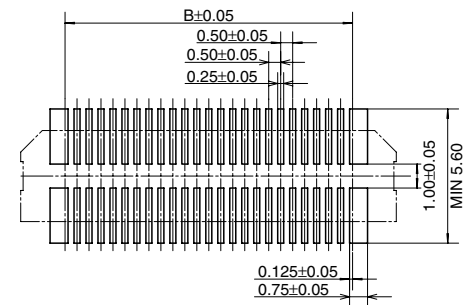

Recommended metal mask pattern
Metal mask thickness: Here, 150 μm
(Opening area ratio: 62%)

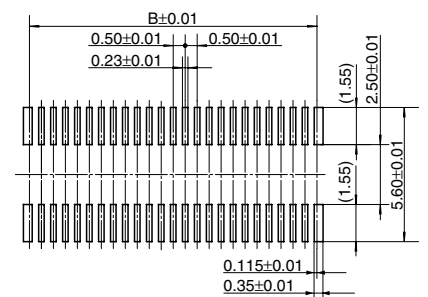

Recommended metal mask pattern
Metal mask thickness: Here, 120 μm
(Opening area ratio: 78%)

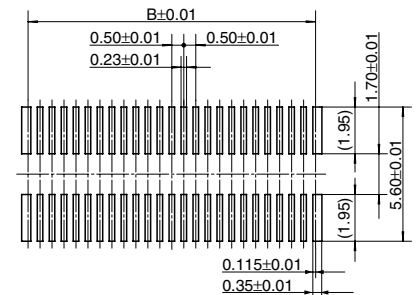

* See the dimension table on page 95 for more information on the B dimension of the socket and header.

AXK(5(S)/6(S))

P5KS: Mated height 4.0mm, 4.5mm, 5.0mm, 5.5mm, 6.0mm, 6.5mm, 7.0mm, 8.0mm, 9.0mm type

• Socket

Recommended PC board pattern
(TOP VIEW)

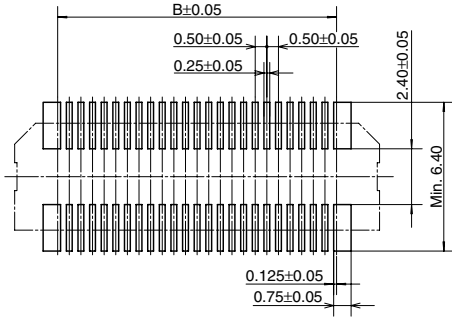

Recommended metal mask pattern
Metal mask thickness: Here, 150 μm
(Opening area ratio: 60%)

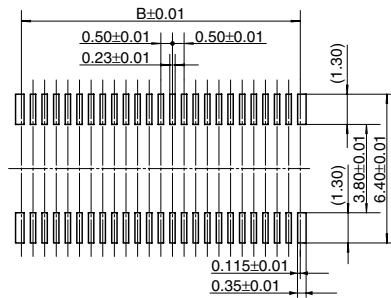

Recommended metal mask pattern
Metal mask thickness: Here, 120 μm
(Opening area ratio: 76%)

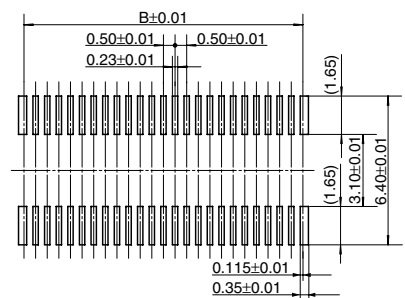

* See the dimension table on page 96 for more information on the B dimension.

• Header

Recommended PC board pattern
(TOP VIEW)

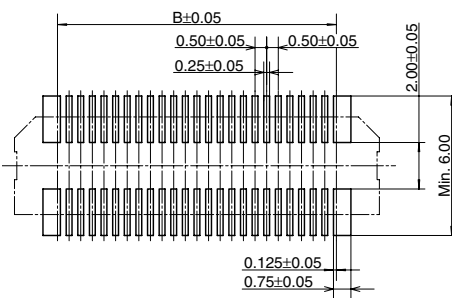

Recommended metal mask pattern
Metal mask thickness: Here, 150 μm
(Opening area ratio: 69%)

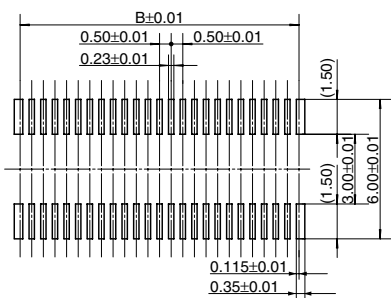

Recommended metal mask pattern
Metal mask thickness: Here, 120 μm
(Opening area ratio: 87%)

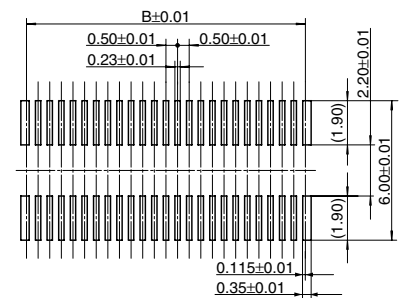

* See the dimension table on page 96 for more information on the B dimension.

P5KS: Mated height 4.0mm, 4.5mm for 120 contacts and 160 contacts types, 6.5mm for 130 contacts type

• Socket

Recommended PC board pattern
(TOP VIEW)

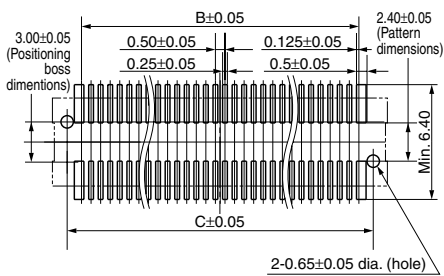

Recommended metal mask pattern
Metal mask thickness: Here, 150 μm
(Opening area ratio: 60%)

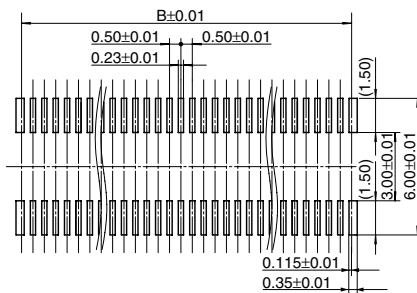

Recommended metal mask pattern
Metal mask thickness: Here, 120 μm
(Opening area ratio: 76%)

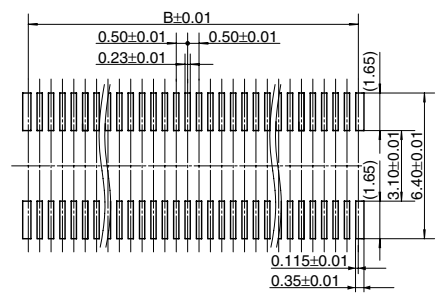

* See the dimension table on page 97 for more information on the B and C dimensions.

• Header

Recommended PC board pattern
(TOP VIEW)

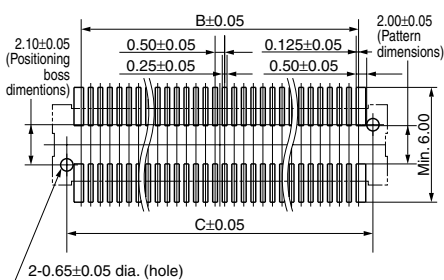

Recommended metal mask pattern
Metal mask thickness: Here, 150 μm
(Opening area ratio: 69%)

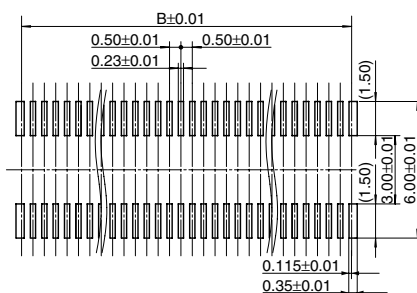

Recommended metal mask pattern
Metal mask thickness: Here, 120 μm
(Opening area ratio: 87%)

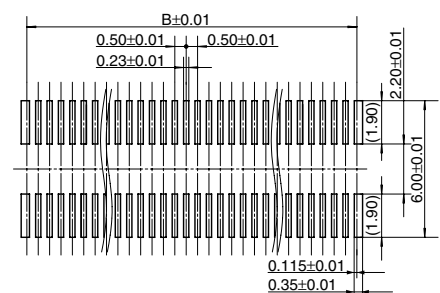

* See the dimension table on page 97 for more information on the B and C dimensions.

For other details, please verify with the product specification sheets.