

# Distinctive Characteristics

Antirotation design, standard on noncylindrical levers, mates toggle and bushing; bottom of toggle has two flatted sides which fit into a complementary opening inside bushing.

Antijamming design protects contacts from damage due to excessive downward force on actuator.

High torque bushing construction prevents rotation or separation from frame during installation.

High insulating barriers increase isolation of circuits in multipole devices and provide added protection to contact points.

Molded diallyl phthalate case has a UL flammability rating of 94V-0.

Epoxy sealed terminals prevent entry of solder flux and other contaminants.

Prominent external insulating barriers increase insulation resistance and dielectric strength.

Interlocked actuator block, lever, and interior guide prevent switch failure due to biased lever movement.

Clinching of frame to case well above base and terminals provides 1,500V dielectric strength.

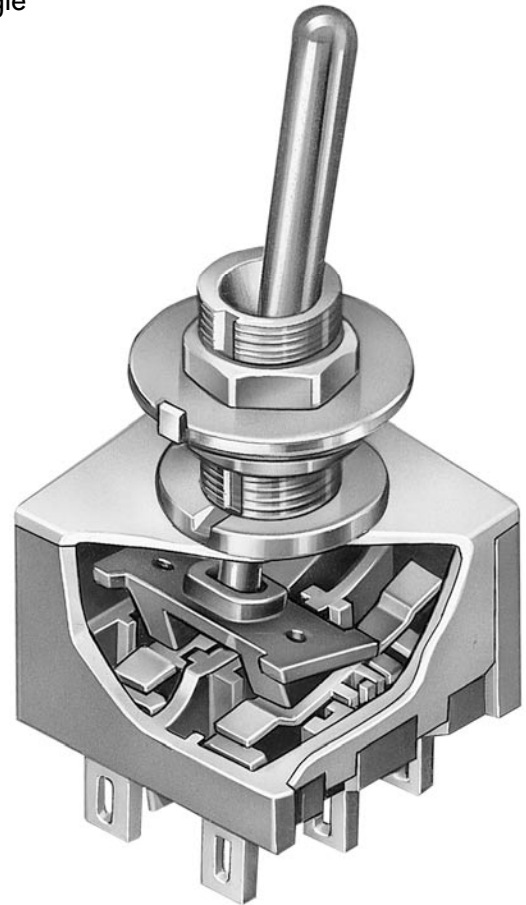

Actual Size

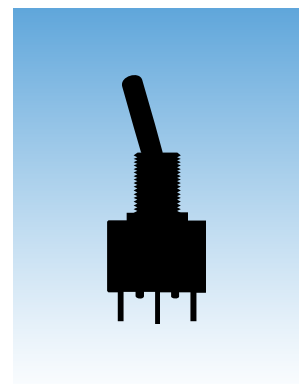

## General Specifications

### Electrical Capacity (Resistive Load)

**Power Level (code W):** 6A @ 125V AC & 3A @ 250V AC  
 4A @ 30V DC for On-None-On & On-None-Off; 3A @ 30V DC for all other circuits

**Logic Level (code G):** 0.4VA maximum @ 28V AC/DC maximum (Applicable Range 0.1mA ~ 0.1A @ 20mV ~ 28V)

**Logic/Power Level (code A):** Combines W & G ratings

Note: Find additional explanation of dual rating & operating range in Supplement section.

### Other Ratings

**Contact Resistance:** 10 milliohms maximum for silver; 20 milliohms maximum for gold

**Insulation Resistance:** 1,000 megohms minimum @ 500V DC

**Dielectric Strength:** 1,000V AC minimum between contacts for 1 minute minimum;  
 1,500V AC minimum between contacts and case for 1 minute minimum

**Mechanical Life:** 100,000 operations minimum; 50,000 operations minimum for flat, locking, & splashproof devices

**Electrical Life:** 25,000 operations minimum for silver; 50,000 operations minimum for gold;  
 50,000 operations minimum for silver at 3A @ 125V AC

**Nominal Operating Force:** 3.92N for Single Pole; 4.41N for Double Pole; 6.86N for Three Pole; 7.85N for Four Pole

**Angle of Throw:** 25°

### Materials & Finishes

<b>Toggle:</b>	Brass with chrome plating	<b>Frame:</b>	Stainless steel
<b>Bushing:</b>	Brass with nickel plating	<b>Support Bracket:</b>	Steel with tin plating
<b>Case:</b>	Diallyl phthalate resin (UL94V-0)		
<b>Movable Contactor:</b>	Phosphor bronze with silver or gold plating		
<b>Movable Contacts:</b>	Silver alloy (code W); copper with gold plating (code G); or silver alloy with gold plating (code A)		
<b>Stationary Contacts:</b>	Silver with silver plating (code W); copper or brass with gold plating (code G); or silver with gold plating (code A)		
<b>Terminals:</b>	Copper or brass with silver plating; or copper or brass with gold plating		

### Environmental Data

**Operating Temp Range:** -30°C through +85°C (-22°F through +185°F)

**Humidity:** 90 ~ 95% humidity for 96 hours @ 40°C (104°F)

**Vibration:** 10 ~ 55Hz with peak-to-peak amplitude of 1.5mm traversing the frequency range & returning in 1 minute; 3 right angled directions for 2 hours

**Shock:** 50G (490m/s<sup>2</sup>) acceleration (tested in 6 right angled directions, with 5 shocks in each direction)

**Sealing:** Panel seal bushing options B3 & D3 meet IP67 of IEC60529 Standards

### Installation

**Mounting Torque:** 3.0Nm (26.55 lb•in) double nut for large bushing;  
 1.5Nm (13 lb•in) double nut & 0.7Nm (6 lb•in) single nut for all other bushings

### Processing

**Soldering:** Wave Soldering (PC version) for Gold: See Profile A in Supplement section.  
 Manual Soldering for Gold: See Profile A in Supplement section.  
 Wave Soldering (PC version) for Silver: See Profile B in Supplement section.  
 Manual Soldering for Silver: See Profile B in Supplement section.  
 Note: Lever must be in OFF (center) position while soldering.

**Cleaning:** These devices are not process sealed. Hand clean locally using alcohol based solution.

### Standards & Certifications

**Flammability Standards:** UL94V-0 for case

**UL Recognized:** All models recognized at 6A @ 125V AC, 3A @ 250V AC or 0.4VA maximum @ 28V DC maximum; UL File No. WOYR2.E44145; add "/U" to end of part number to order UL mark on switch.

**C-UL Recognized:** All models recognized at 6A @ 125V AC, 3A @ 250V AC or 0.4VA maximum @ 28V DC maximum; C-UL File No. WOYR8.E44145; add "/C-UL" to end of part number to order C-UL mark on switch.

**CSA Certified:** All models recognized at 6A @ 125V AC or 3A @ 250V AC or 0.4VA maximum @ 28V maximum; CSA File No. 023535-0-000; add "/C" to end of part number to order CSA mark on switch.



**TYPICAL SWITCH ORDERING EXAMPLE**

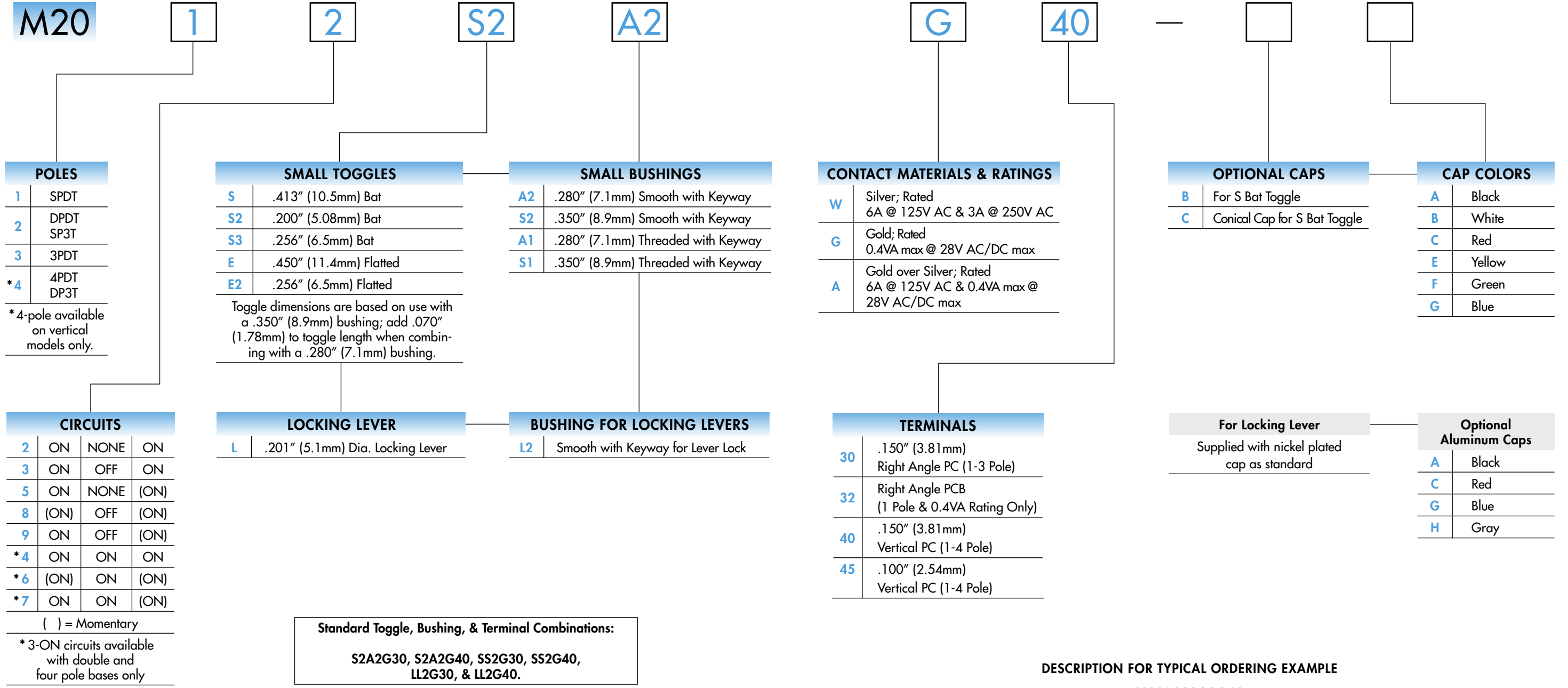

**DESCRIPTION FOR TYPICAL ORDERING EXAMPLE**



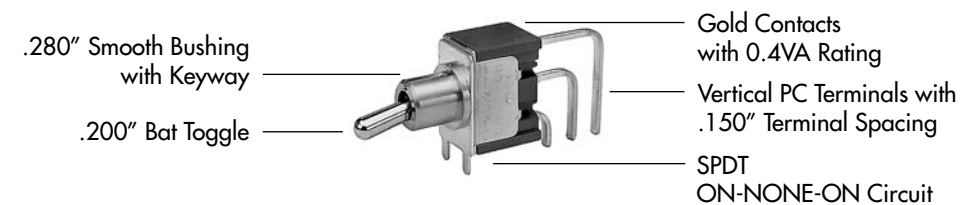



**M2012S2A2G40**



**IMPORTANT:**

Switches are supplied without UL, C-UL & CSA marking unless specified. Specific models & ratings noted on General Specifications page.

## POLES & CIRCUITS

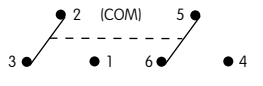
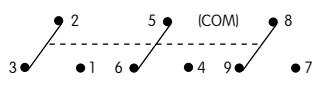
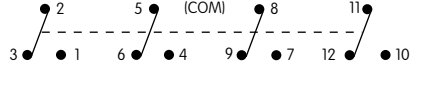
Pole	Model	Toggle Position ( ) = Momentary			Connected Terminals			Throw & Schematics
		Down 	Center 	Up 	Down 	Center 	Up 	
SP	M2012 *M2013 M2015 *M2018 M2019	ON ON ON (ON) ON	NONE OFF NONE OFF OFF	ON ON (ON) ON ON	2-3	OPEN	2-1	SPDT 
DP	M2022 *M2023 M2025 *M2028 M2029	ON ON ON (ON) ON	NONE OFF NONE OFF OFF	ON ON (ON) ON ON	2-3 5-6	OPEN	2-1 5-4	DPDT 
3P	M2032 M2033 M2035 M2038 M2039	ON ON ON (ON) ON	NONE OFF NONE OFF OFF	ON ON (ON) ON ON	2-3 5-6 8-9	OPEN	2-1 5-4 8-7	3PDT 
4P	M2042 M2043 M2045 M2048 M2049	ON ON ON (ON) ON	NONE OFF NONE OFF OFF	ON ON (ON) ON ON	2-3 5-6 8-9 11-12	OPEN	2-1 5-4 8-7 11-10	4PDT 

### For 3 Throw (3-On)

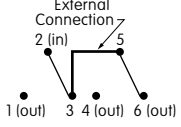
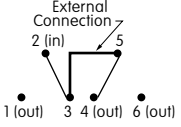
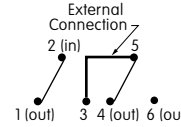
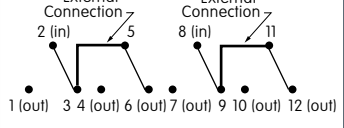
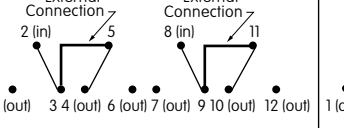
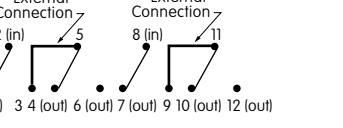
Pole	Model	Down	Center	Up	Connected Terminals & Schematics		
SP	M2024 M2026 M2027	ON (ON) ON	ON ON ON	ON (ON) (ON)	 2-3 5-6	 2-3 5-4	 2-1 5-4
DP	M2044 M2046 M2047	ON (ON) ON	ON ON ON	ON (ON) (ON)	 2-3 5-6 8-9 11-12	 2-3 5-4 8-9 11-10	 2-1 5-4 8-7 11-10

The SP3T model utilizes a double pole base.

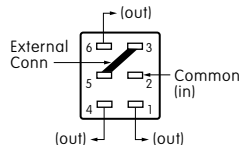

External connection must be made during field installation.

The DP3T model utilizes a four pole base.

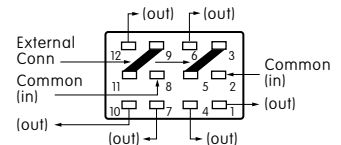

External connection must be made during field installation.

### SMALL TOGGLES

**Important:**

Toggle length changes based on bushing selected. All illustrations are shown with .350" (8.9mm) long bushing. When using a .280" (7.1mm) long bushing, toggle length increases .070" (1.78mm).

**S** .413" (10.5mm) Bat

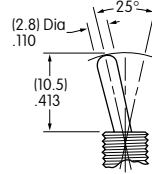

**S2** .200" (5.08mm) Bat

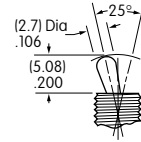

**S3** .256" (6.5mm) Bat

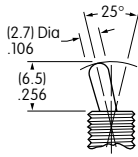

**E** .450" (11.4mm) Flatted

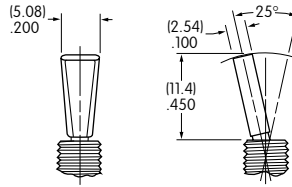

**E2** .256" (6.5mm) Flatted

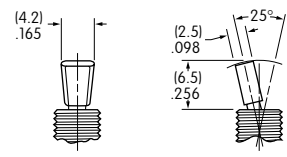

**Standard Material & Finish:** Brass with Bright Chrome  
Contact factory for optional finishes.

### SMALL BUSHINGS

**A2** .280" (7.1mm) Smooth with Keyway

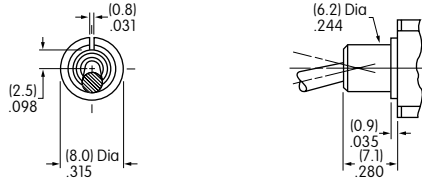

**S2** .350" (8.9mm) Smooth with Keyway

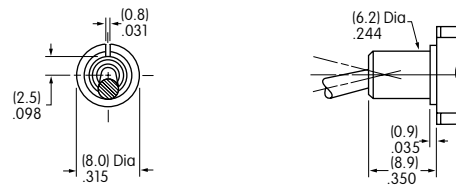

When using this bushing, toggle length is increased by .070" (1.78mm).

**A1** .280" (7.1mm) Threaded with Keyway

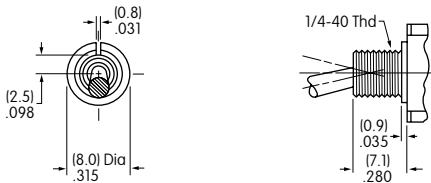

**S1** .350" (8.9mm) Threaded with Keyway

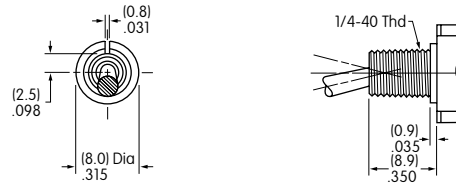

When using this bushing, toggle length is increased by .070" (1.78mm). Maximum Panel Thickness with Standard Hardware: .031" (0.8mm)

Maximum Panel Thickness with Standard Hardware: .102" (2.6mm)

### Panel Cutouts

For A2, S2, A1 or S1 Bushing with Keyway

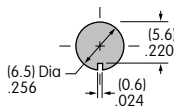

For A1 or S1 Bushing with Locking Ring

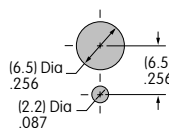

### Standard Hardware:

- 2 Hex Nuts (AT513H)
- 1 Lockwasher (AT509)
- 1 Locking Ring (AT507H)

For dimensions, see Accessories & Hardware section.

## LOCKING LEVER & BUSHING

**LL2**

**Smooth with Keyway**

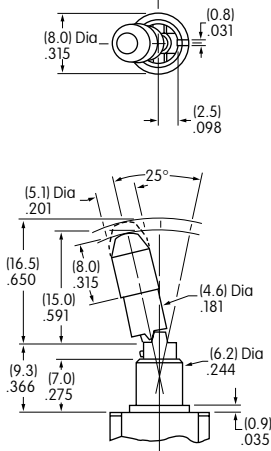

**Cap for Locking Lever**

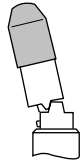

**Supplied with Cap AT427**

**Material & Finish:**  
Brass with Nickel Plating

**Lever Material & Finish:**  
Brass with Chrome Plating

**Color Codes for  
Optional Anodized Aluminum Caps**

- |                |                                     |
|----------------|-------------------------------------|
| <b>A</b> Black | <b>G</b> Blue                       |
| <b>C</b> Red   | <b>H</b> Gray<br>(natural aluminum) |

**Locking Mechanism**

on-none-on

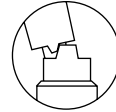

2 positions lock

on-none-(on)



1 position locks

on-off-(on)  
on-on-(on)

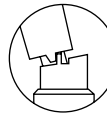

2 positions lock

on-off-on  
on-on-on

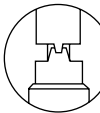

3 positions lock

(on)-off-(on)  
(on)-on-(on)

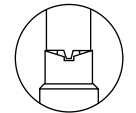

1 position locks

## CONTACT MATERIALS & RATINGS

**W**

**Silver over Silver**

**Power Level**

**6A @ 125V AC & 3A @ 250V AC**

**G**

**Gold over Brass or Copper**

**Logic Level**

**0.4VA maximum @ 28V AC/DC maximum**

Note: See Supplement section to find complete explanation of operating range.

**A**

**Gold over Silver**

**Power Level  
or Logic Level**

**6A @ 125V AC  
or 0.4VA maximum @ 28V AC/DC maximum**

Note: This dual rated option is suitable when two or more identical switches are used in logic and in power circuits within the same application. See Supplement section to find complete explanation of dual rating and operating range.

## TERMINALS

**30**

**.150" (3.81mm)  
Right Angle PC (1-3 Pole)**

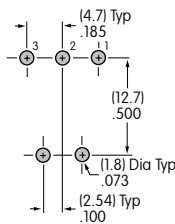
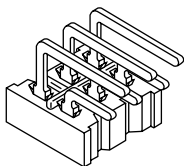

Single Pole

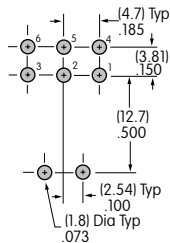

Double Pole

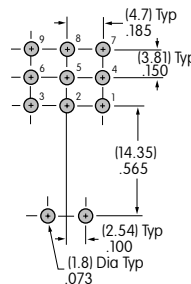

Three Pole

**32**

**Right Angle PCB  
with Reverse Circuit  
(1 Pole & 0.4VA Rating Only)**

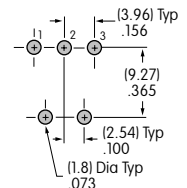
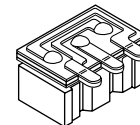

Terminal dimensions are shown on the Typical Switch Dimensions pages which follow.

### TERMINALS (Continued)

#### 40 .150" (3.81mm) Vertical PC (1-4 Pole)

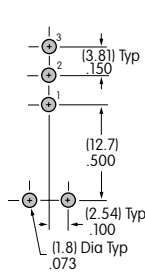
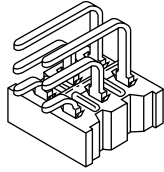

Single Pole

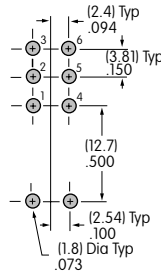

Double Pole

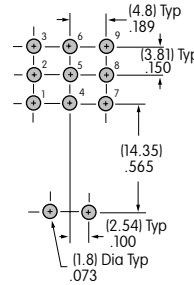

Three Pole

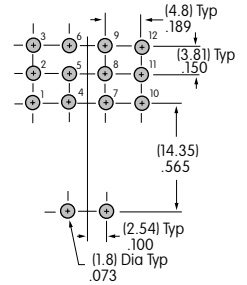

Four Pole

#### 45 .100" (2.54mm) Vertical PC (1-4 Pole)

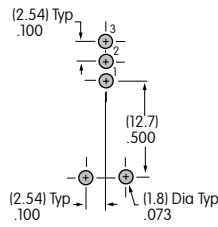
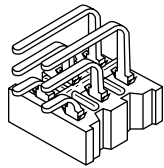

Single Pole

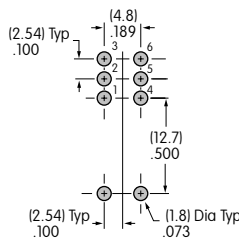

Double Pole

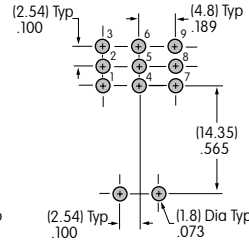

Three Pole

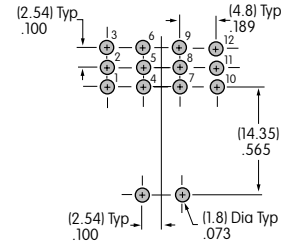

Four Pole

Terminal dimensions are shown on the Typical Switch Dimensions pages which follow.

### OPTIONAL CAPS & CAP COLORS

#### B AT415 for S Bat Toggle

Material:  
Polyethylene

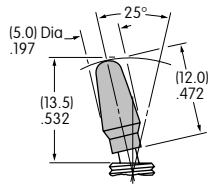

#### C AT444 Conical Cap for S Bat Toggle

Material:  
Polyethylene

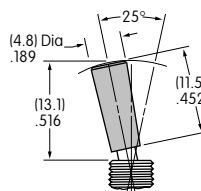

#### Colors Available

<b>A</b> Black	<b>E</b> Yellow
<b>B</b> White	<b>F</b> Green
<b>C</b> Red	<b>G</b> Blue

### STANDARD HARDWARE

**AT513H for Inch**  
**AT513M for Metric**  
Hex Nut (2 per switch)  
Brass/Nickel

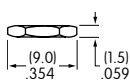
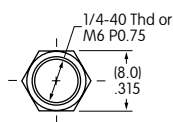

**AT507H for Inch**  
**AT507M for Metric**  
Locking Ring (1 per switch)  
Steel with Zinc/Chromate

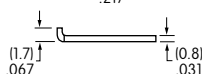
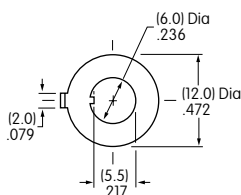

**AT509**  
Lockwasher (1 per switch, none with splashproof)  
Steel with Zinc/Chromate

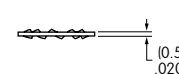
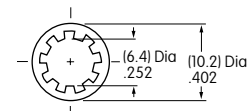

### TYPICAL SWITCH DIMENSIONS

#### .150" (3.81mm) Right Angle PC

#### Single Pole

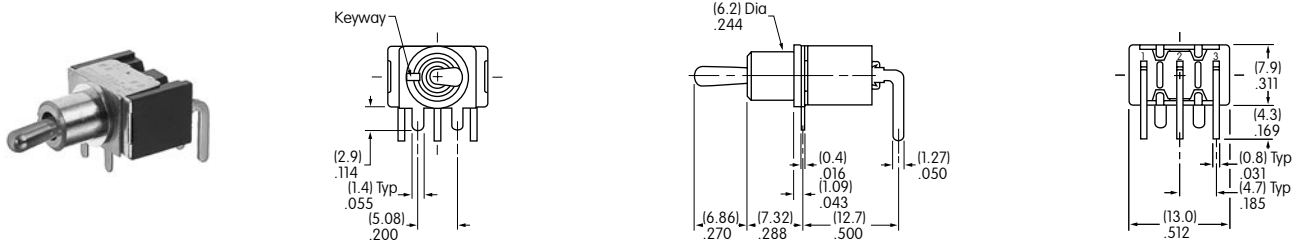

M2012S2A2G30

#### .150" (3.81mm) Right Angle PC

#### Double Pole

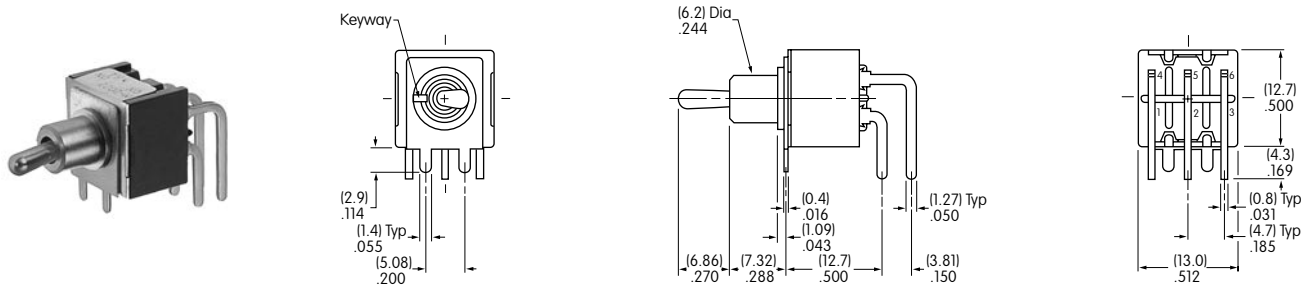

M2022S2A2G30

#### .150" (3.81mm) Right Angle PC

#### Three Pole

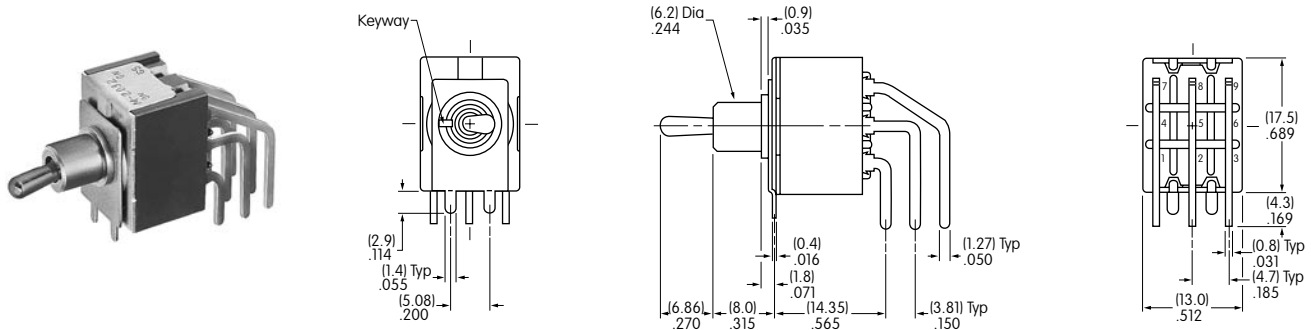

M2032S2A2G30

#### Right Angle PCB

#### Single Pole • Reverse Circuit

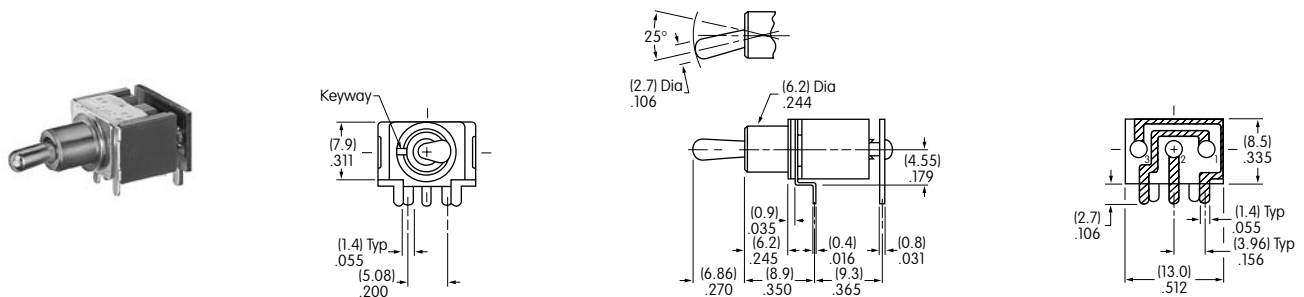

M2012S2A2G32



## TYPICAL SWITCH DIMENSIONS

### Single Pole

### .150" (3.81mm) Vertical PC

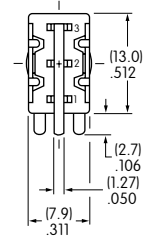
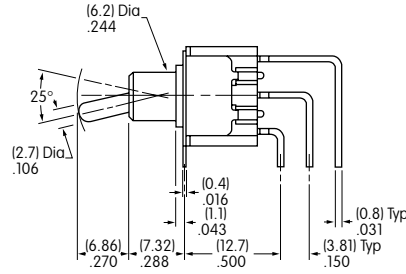
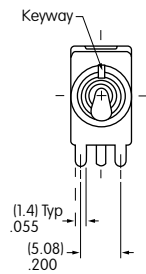
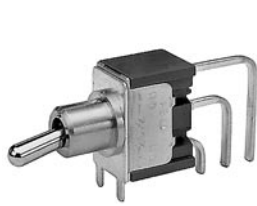

M2012S2A2G40

### Double Pole

### .150" (3.81mm) Vertical PC

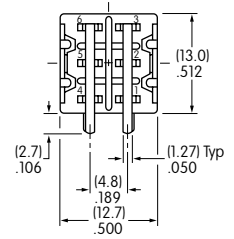
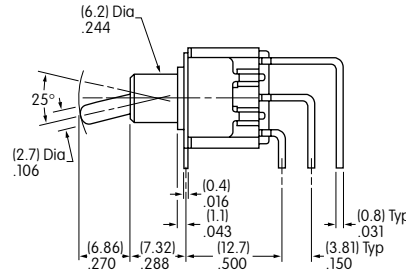
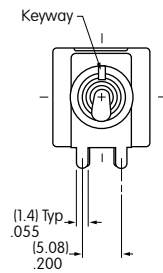

M2022S2A2G40

### Three Pole

### .150" (3.81mm) Vertical PC

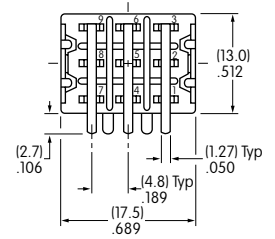
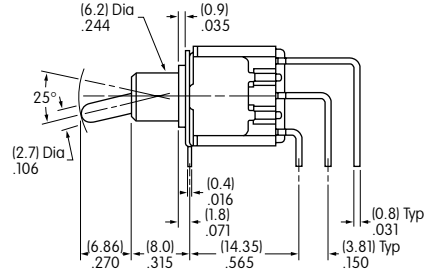
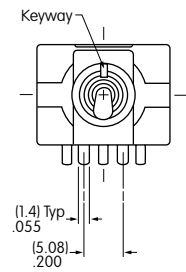

M2032S2A2G40

### Four Pole

### .150" (3.81mm) Vertical PC

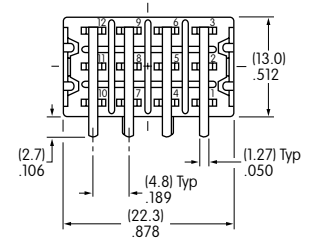
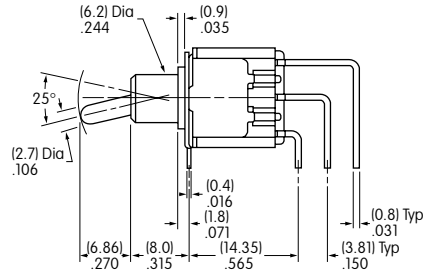
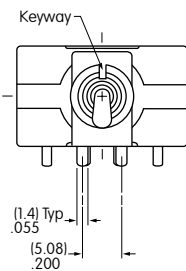

M2042S2A2G40

### TYPICAL SWITCH DIMENSIONS

#### .100" (2.54mm) Vertical PC

#### Single Pole

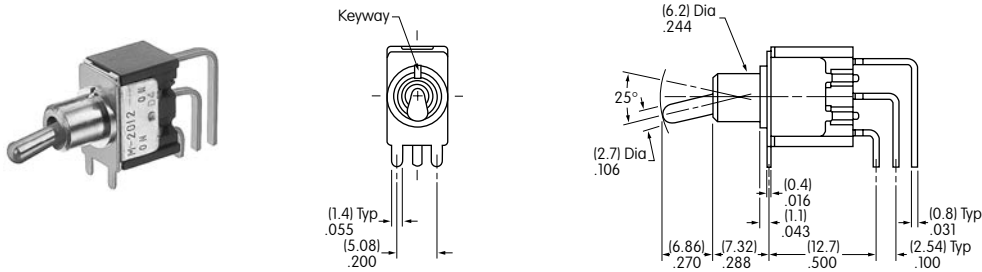

M2012S2A2G45

#### .100" (2.54mm) Vertical PC

#### Double Pole

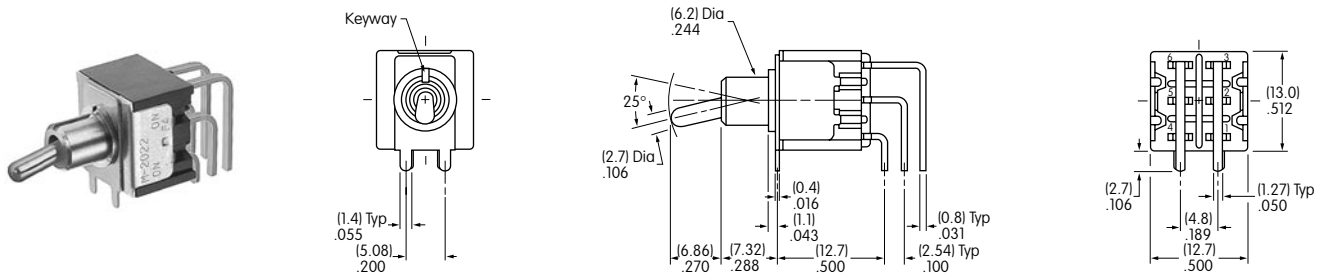

M2022S2A2G45

#### .100" (2.54mm) Vertical PC

#### Three Pole

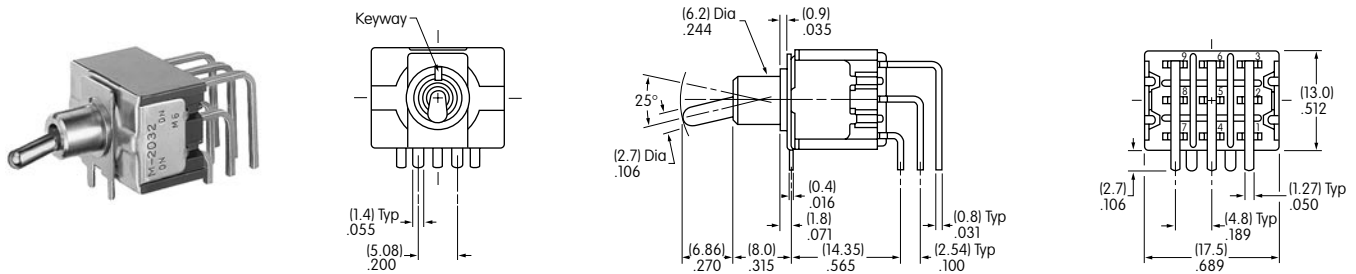

M2032S2A2G45

#### .100" (2.54mm) Vertical PC

#### Four Pole

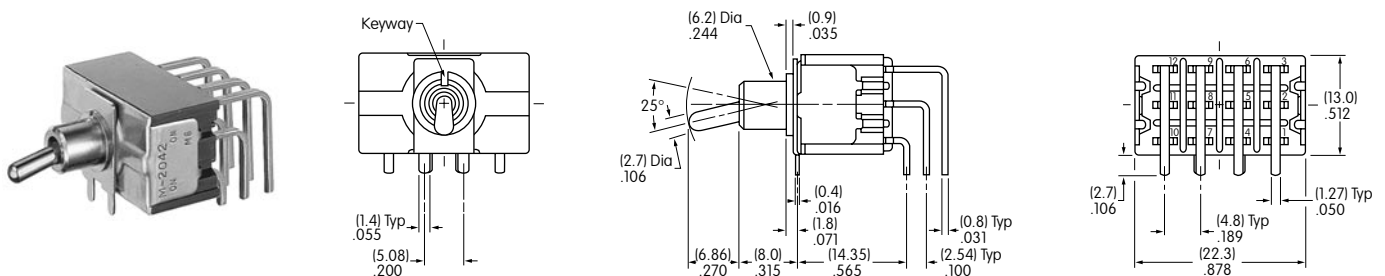

M2042S2A2G45