

Distinctive Characteristics

Power and logic level capabilities available to suit varying applications.

Bushing and snap-in mount versions available; snap-in models offer many style and color choices to enhance front panel appearance.

Light touch actuation.

High torque bushing prevents rotation and separation from metal frame during installation.

Stainless steel frame resists corrosion.

Case of heat resistant resin meets UL 94V-0 flammability rating.

Higher insulating barriers protect against crossover in double pole devices.

1,500V dielectric strength between contacts and case is accomplished by clinching the frame away from the terminals.

Epoxy sealed terminals prevent entry of solder flux and other contaminants.

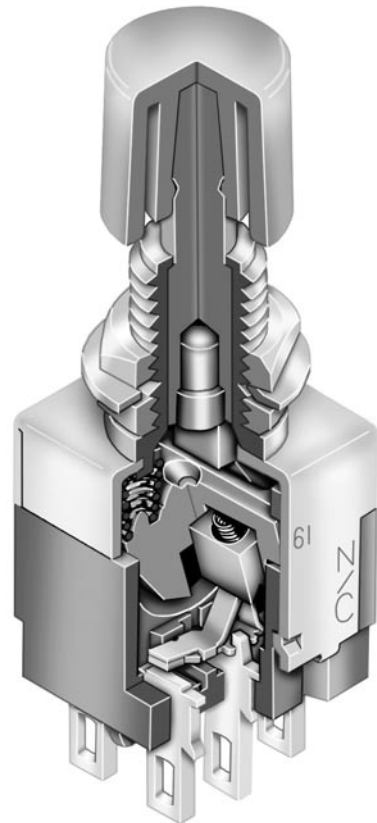

Actual Size

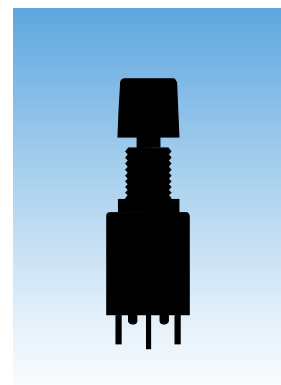

General Specifications

Electrical Capacity (Resistive Load)

Power Level (No code or P): 3A @ 125V AC for silver contacts
Logic Level (code G or PG): 0.4VA maximum @ 28V AC/DC maximum for gold contacts
 (Applicable Range 0.1mA ~ 0.1A @ 20mV ~ 28V)
 Note: Find additional explanation of operating range in Supplement section.

Other Ratings

Contact Resistance: 10 milliohms maximum for silver; 20 milliohms maximum for gold
Insulation Resistance: 1,000 megohms minimum @ 500V DC
Dielectric Strength: 1,000V AC minimum between contacts for 1 minute minimum;
 1,500V AC minimum between contacts and case for 1 minute minimum
Mechanical Life: 100,000 operations minimum
Electrical Life: 25,000 operations minimum for silver;
 50,000 operations minimum for gold
Nominal Operating Force: Single Pole: 2.35N for Momentary and 2.65N for Alternate Action
 Double Pole: 2.94N for Momentary and 3.63N for Alternate Action
Travel: Momentary: Pretravel .047" (1.2mm); Overtravel .016" (0.4mm); Total Travel .063" (1.6mm)
 Alternate: Pretravel .071" (1.8mm); Overtravel .016" (0.4mm); Total Travel .087" (2.2mm)

Materials & Finishes

Plunger: Brass with chrome plating for Momentary; brass with nickel plating for Alternate
Bushing: Brass with nickel plating
Frame: Stainless steel
Case: Melamine phenolic resin (UL94V-0)
Movable Contacts: Copper with silver or gold plating
Stationary Contacts: Silver with silver or gold plating
Terminals: Copper with silver or gold plating



Environmental Data

Operating Temp Range: -10°C through +70°C (+14°F through +158°F)
Humidity: 90 ~ 95% humidity for 96 hours @ 40°C (104°F)
Vibration: 10 ~ 55Hz with peak-to-peak amplitude of 1.5mm traversing the frequency range and returning in 1 minute; 3 right angled directions for 2 hours
Shock: 50G (490m/s²) acceleration (tested in 6 right angled directions, with 5 shocks in each direction)

Installation

Mounting Torque: 1.47Nm (13.0 lb•in) for double nut; 0.68Nm (6.0 lb•in) for single nut
Cap Installation Force: 78.5N (17.65 lbf) maximum downward force on actuator
Soldering Time & Temp: Wave Solder (Straight PC): See Profile B in Supplement section.
 Manual Soldering: See Profile B in Supplement section.
Cleaning: These devices are not process sealed. Hand clean locally using alcohol based solution.

Standards & Certifications

Flammability Standards: UL94V-0 case
 **UL Recognized:** All single and double pole models recognized at 3A @ 125V AC; UL File No. WOYR2.E44145; add "/U" to end of part number to order UL mark on switch.
 **C-UL Recognized:** All single and double pole models recognized at 3A @ 125V AC; UL File No. WOYR8.E44145; add "/C-UL" to end of part number to order C-UL mark on switch.
 **CSA Certified:** Single pole solder lug and PC models certified at 3A @ 125V AC; double pole PC models certified at 3A @ 125V AC; CSA File No. 023535-0-000; add "/C" to end of part number to order CSA mark on switch.

TYPICAL SWITCH ORDERING EXAMPLE

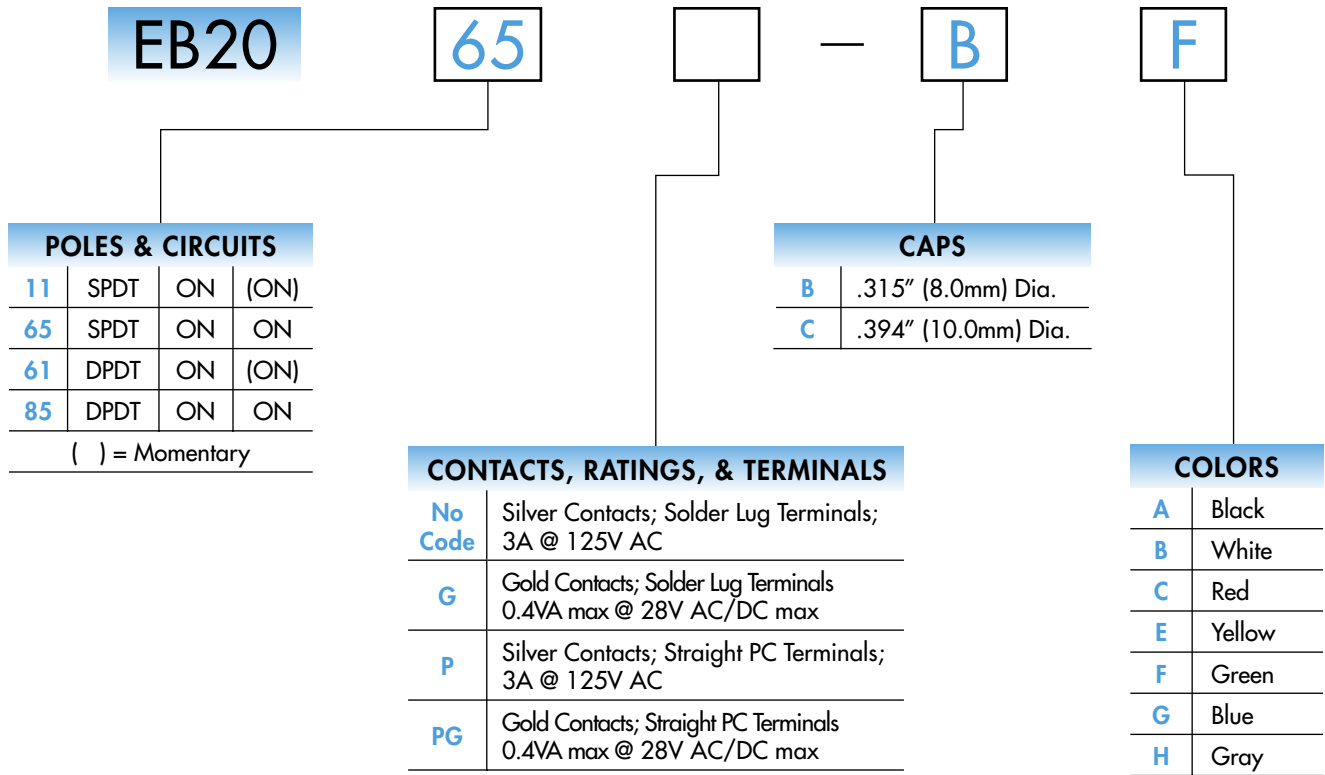

IMPORTANT:





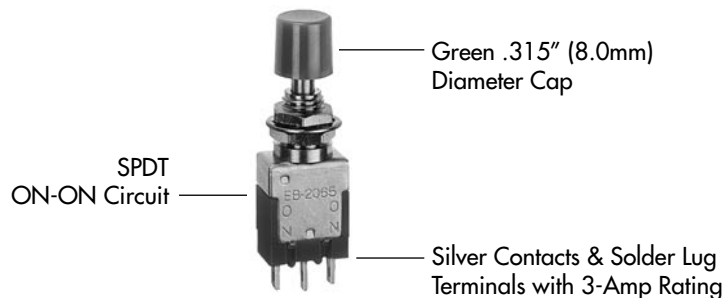

Switches are supplied without UL, C-UL & CSA markings unless specified. Specific models & ratings noted on General Specifications page.

DESCRIPTION FOR TYPICAL ORDERING EXAMPLE

EB2065-BF

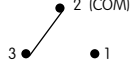
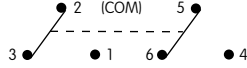

POLES & CIRCUITS

Pole	Model	Plunger Position () = Momentary		Connected Terminals		Throw & Switch Schematics
		Normal  Keyway	Down 	Normal  Keyway	Down 	
SP	EB2011 EB2065	ON ON	(ON) ON	2-3	2-1	SPDT 
DP	EB2061 EB2085	ON ON	(ON) ON	2-3 5-6	2-1 5-4	DPDT 

Note: Terminal numbers are not actually on the switch.

CONTACT MATERIALS, RATINGS, & TERMINALS



**Solder Lug
Silver Contacts**

Power Level

3A @ 125V AC



**Solder Lug
Gold Contacts**

Logic Level

0.4VA max @ 28V AC/DC max

Complete explanation of operating range in Supplement section.

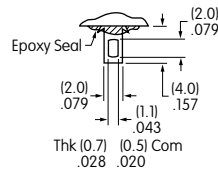

**Straight PC
Silver Contacts**

Power Level

3A @ 125V AC



**Straight PC
Gold Contacts**

Logic Level

0.4VA max @ 28V AC/DC max

Complete explanation of operating range in Supplement section.

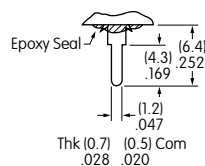

PCB Footprints

Single Pole

Double Pole

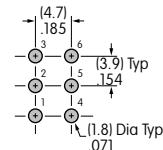
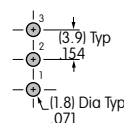

CAPS & COLORS

B AT443
.315" (8.0mm) Diameter Snap-on Cap

C AT442
.394" (10.0mm) Diameter Snap-on Cap

Cap Colors Available:

- | | |
|-----------------|----------------|
| A Black | F Green |
| B White | G Blue |
| C Red | H Gray |
| E Yellow | |

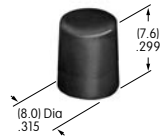

Cap Material: Polycarbonate Finish: Glossy

Cap Colors Available:

- | | |
|-----------------|----------------|
| A Black | F Green |
| B White | G Blue |
| C Red | H Gray |
| E Yellow | |

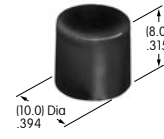

Cap Material: Polycarbonate Finish: Glossy

Plunger Extension

Due to a difference in plunger lengths on the momentary and alternate action models, cap distance from top of bushing varies.

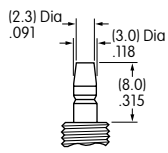

Momentary Plunger Length

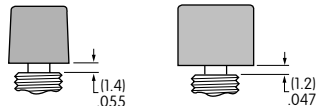

Momentary Cap Location

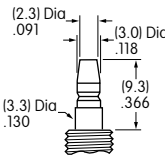

Alternate Plunger Length

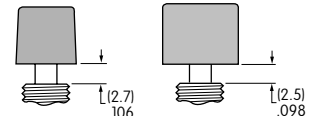

Alternate Cap Location

TYPICAL SWITCH DIMENSIONS

Solder Lug



EB2011-BA

Single Pole

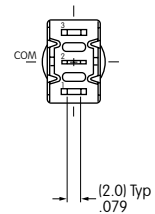
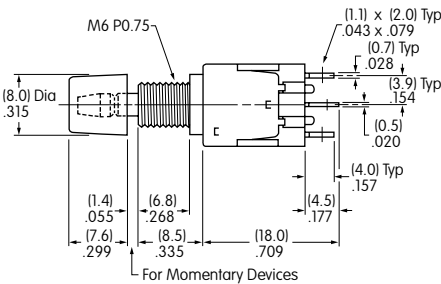
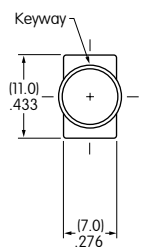

Solder Lug



EB2061-BA

Double Pole

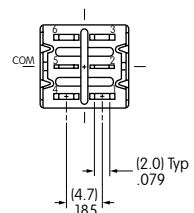
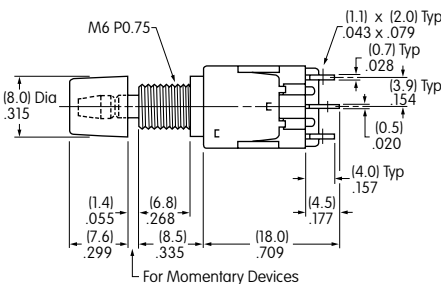
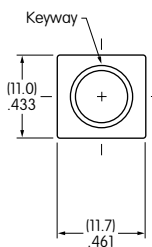

HARDWARE

Installation/Assembly

2 AT513M Metric Hexagon Nuts
1 AT509 Internal Tooth Lockwasher

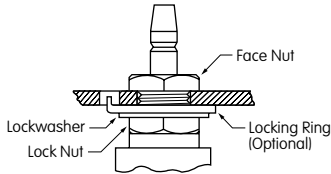

Optional Hardware:
AT507M Metric Locking Ring

Note: Cap must be snapped on after the switch is mounted into the panel.

Standard Hardware

AT513M
Metric Hexagon Nut

Material:
Brass with
Nickel Plating

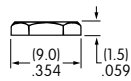
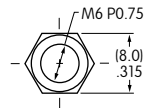

AT509
Lockwasher

Material:
Steel with
Zinc/Chromate

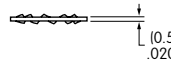
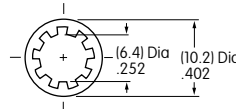

Optional Hardware

AT507M
Metric Locking Ring

Material:
Steel with
Zinc/Chromate

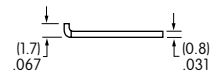
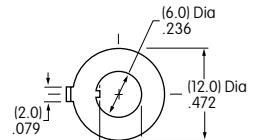

Panel Thicknesses & Panel Cutouts

Metric Bushing

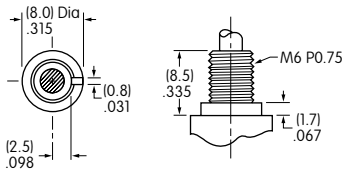

With Standard Hardware

Maximum Effective
Panel Thickness:
.118" (3.0mm)

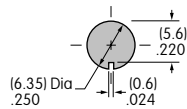

With Standard Hardware & Optional Locking Ring

Maximum Effective
Panel Thickness:
.055" (1.4mm)

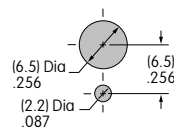

Without Bottom Hex Nut

Maximum Effective
Panel Thickness:
.185" (4.7mm)

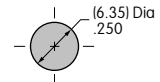

See Accessories & Hardware section for optional Conical Nuts:
AT512M used with cap AT443 and AT512CM used with cap AT442.