

## Audio Limiter

### ■ GENERAL DESCRIPTION

The **NJM2761** is the audio limiter for speaker protection. The limit level is adjustable by external resistor. It is suitable for PC, portable audio and others.

### ■ PACKAGE OUTLINE

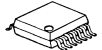

**NJM2761RB2**

**NJM2761V**

### ■ FEATURES

- |   |                 |
|---|-----------------|
| ● Wide Operating Voltage                    | +2.7V to +13.0V |
| ● Variable Limit Level by external resistor | 0.2 to 1V       |
| ● Low Output Noise                          | -90dBV max.     |
| ● Bipolar Technology                        |                 |
| ● Package Outline                           | TVSP10, SSOP14  |

### ■ BLOCK DIAGRAM

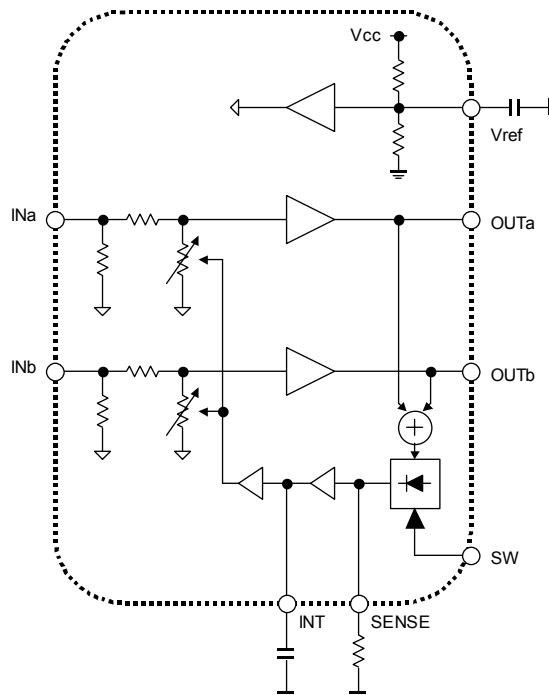

# NJM2761

## ■ PIN CONFIGURATION

TVSP10

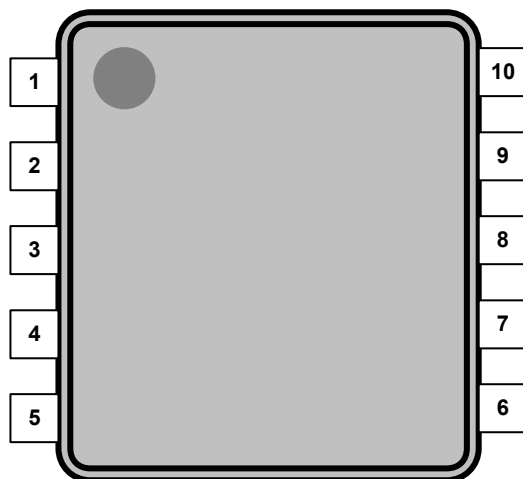

1. V+
2. OUTa
3. INa
4. INT
5. VREF
6. SENCE
7. SW
8. INb
9. OUTb
10. GND

SSOP14

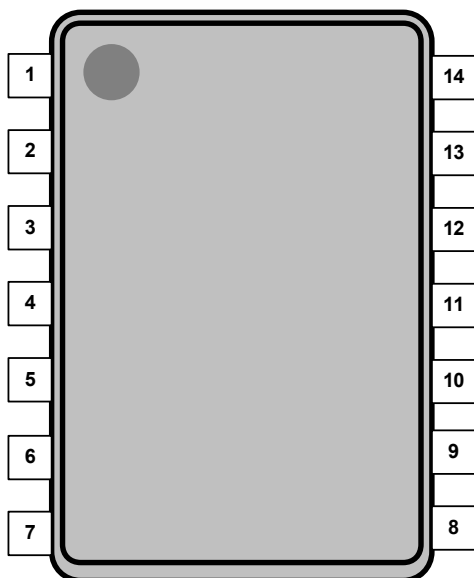

1. V+
2. OUTa
3. INa
4. INT
5. VREF
6. NC
7. NC
8. NC
9. NC
10. SENCE
11. SW
12. INb
13. OUTb
14. GND

## ■ABSOLUTE MAXIMUM RATING (Ta=25°C)

PARAMETER	SYMBOL	RATINGS	UNIT
Supply Voltage	V <sup>+</sup>	14	V
Power Dissipation	P <sub>D</sub>	320	mW
Operating Temperature Range	T <sub>opr</sub>	-20 to +75	°C
Storage Temperature Range	T <sub>stg</sub>	-40 to +125	°C

## ■ELECTRICAL CHARACTERISTICS

### ● POWER SUPPLY (Ta=25°C, V<sup>+</sup>=5V unless otherwise specified)

PARAMETER	SYMBOL	TEST CONDITION	MIN.	TYP.	MAX.	UNIT
Operating Voltage	V <sup>+</sup>	-	2.7	5.0	13.0	V
Operating Current	I <sub>CC</sub>	No Signal	-	1.5	2.0	mA
Reference Voltage	V <sub>ref</sub>	No Signal	2.2	2.5	2.7	V

### ● AC CHARACTERISTICS

(Ta=25°C, V<sup>+</sup>=5V, V<sub>IN</sub>=1Vrms/f=1kHz, R<sub>sense</sub>=20kΩ, BW=400-30kHz unless otherwise specified)

PARAMETER	SYMBOL	TEST CONDITION	MIN.	TYP.	MAX.	UNIT
Limit Level 1	G <sub>LIM1</sub>		150	200	250	mVrms
Limit Level 2	G <sub>LIM2</sub>	V <sup>+</sup> =13V, R <sub>sense</sub> =4kΩ, V <sub>IN</sub> =2Vrms	0.7	1.0	1.3	Vrms
Limit Off	G <sub>OFF</sub>	SW=2V	0.9	1.0	1.1	Vrms
Output Noise	V <sub>NO</sub>	R <sub>S</sub> =0Ω, A-weighting,	-	-100 (10)	-90 (31.6)	dBV (μVrms)
Total Harmonic Distortion	THD+N		-	-	1	%
Cross Talk	CT		-	-	-70	dB
Ripple Rejection	RR	V <sub>ripple</sub> =100mVrms, f=1kHz	-	-	-70 (316)	dBV (μVrms)

### ● CONTROL CHARACTERISTICS (Ta=25°C, V<sup>+</sup>=5V unless otherwise specified)

PARAMETER	SYMBOL	TEST CONDITION	MIN.	TYP.	MAX.	UNIT
Low Level Input Voltage	V <sub>IL</sub>	-	-	-	0.5	V
High Level Input Voltage	V <sub>IH</sub>	-	2.0	-	-	V
Control Current	I <sub>sw</sub>	SW=5V	-	-	100	μA

## ■CONTROL TERMINAL EXPLANATION

SW(TVSP10:7pin, SSOP14:10pin)

MODE	STATUS	NOTE
Limiter ON	L	Limiter is active.
Limiter OFF	H	Limiter is not active.

# NJM2761

## ■ TERMINAL DESCRIPTION

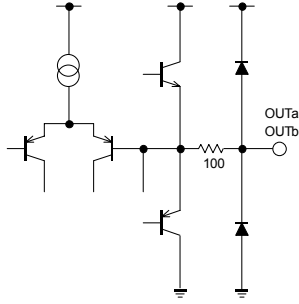
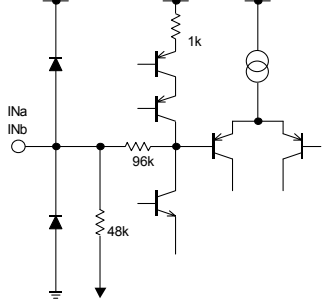
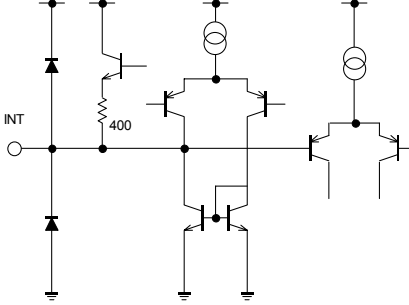
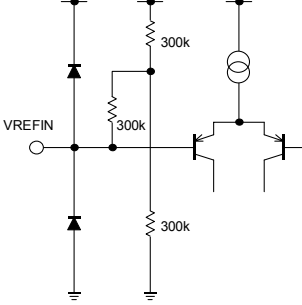
No. TVSP10(SSOP14)	SYMBOL	FUNCTION	EQUIVALENT CIRCUIT	VOLTAGE
1	V+	Power Supply Terminal		-
2 9(13)	OUTa OUTb	Ach Output Terminal Bch Output Terminal		V+/2
3 8(12)	INa INb	Ach Input Terminal Bch Input Terminal		V+/2
4	INT	Smoothing Capacitor Connection Terminal		0.7V
5	VREFIN	Reference Voltage Stabilizing Capacitor Connection Terminal		V+/2

## ■TERMINAL DESCRIPTION

No. TVSP10(SSOP14)	SYMBOL	FUNCTION	EQUIVALENT CIRCUIT	VOLTAGE
6(10)	SENSE	Resister Connection Terminal for Limit Level Setting		0V
7(11)	SW	Limiter ON/OFF Switch		-
10(14)	GND	Ground Terminal		-

# NJM2761

## APPLICATION CIRCUIT

TVSP10

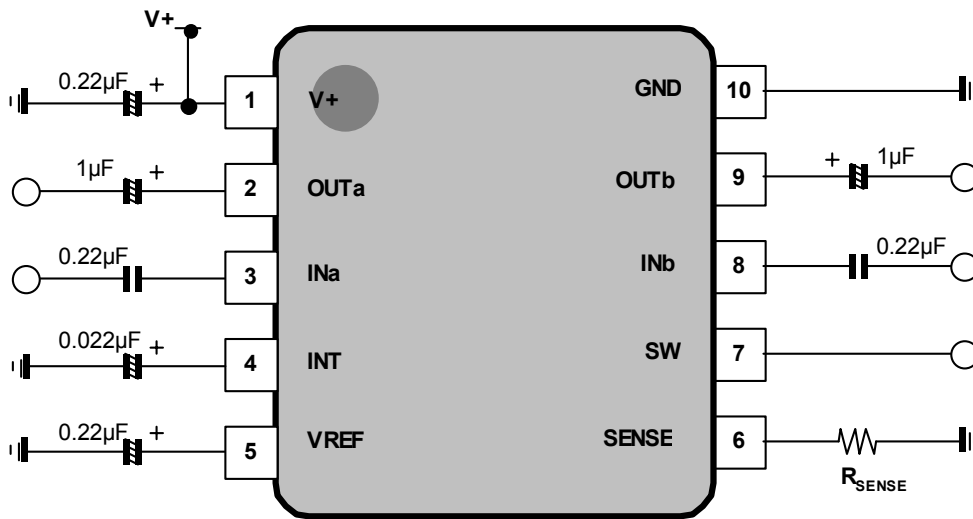

SSOP14

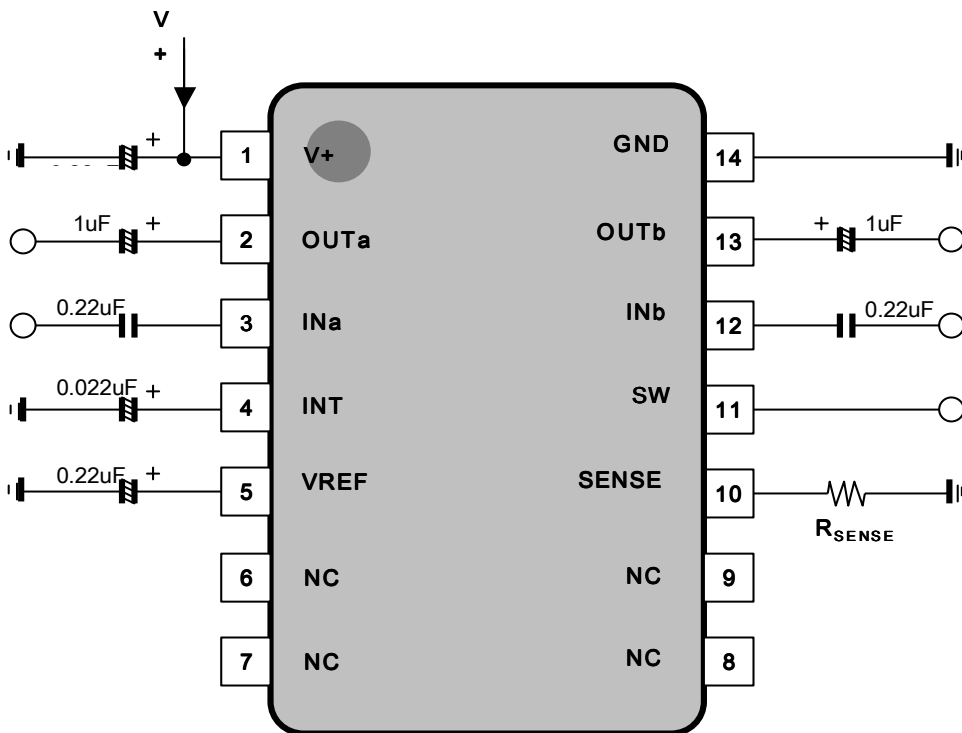

\* The limit level is twice as much as set point when a signal is input into a either one channel of Ach or Bch.

\* For the above reason, monaural signal should input both INa and INb.

$$R_{SENSE} = 4000 / V_{lim} [\text{Ohm}]$$

$V_{lim}$ : Limit level (Vrms)

Limit range: 200mVrms to 1Vrms (20k to 4kOhm)

## TYPICAL CHARACTERISTICS

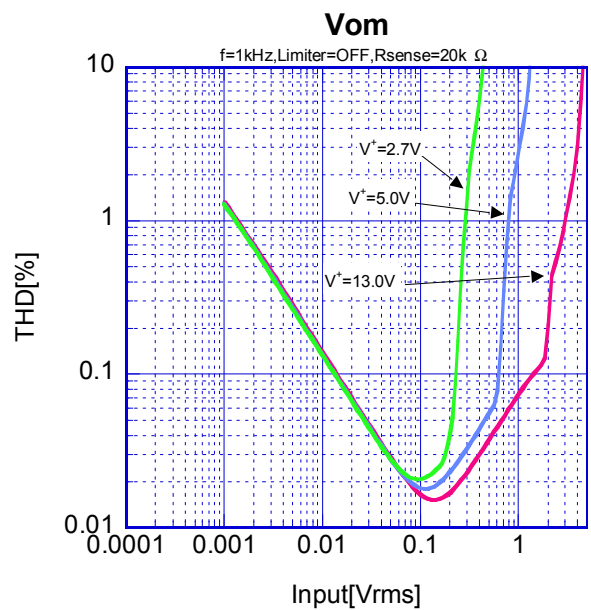
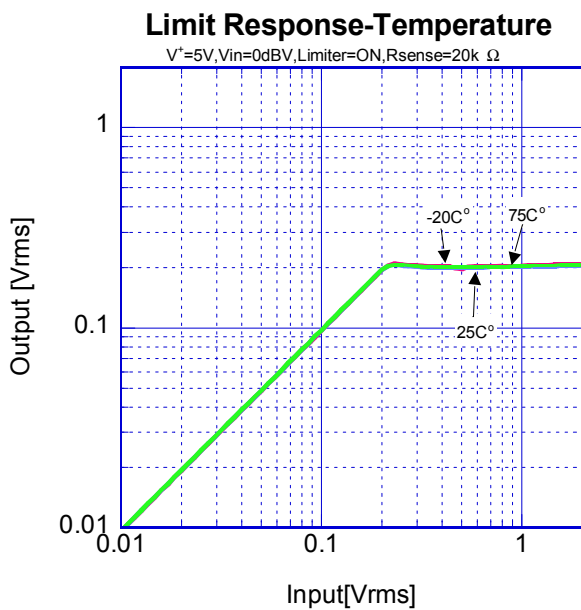
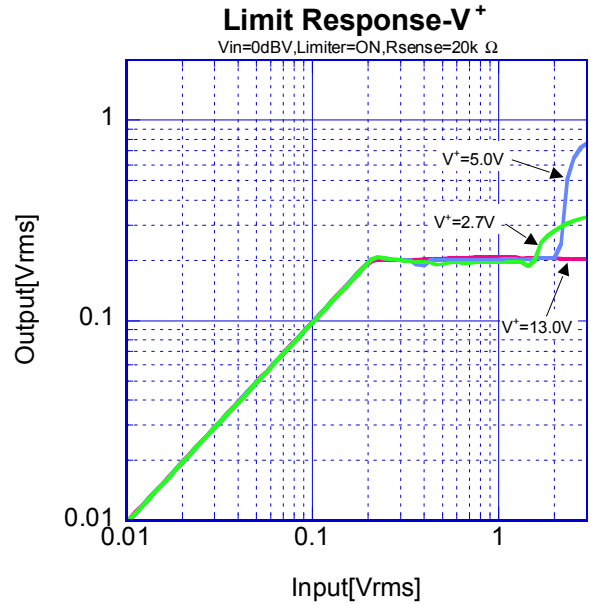
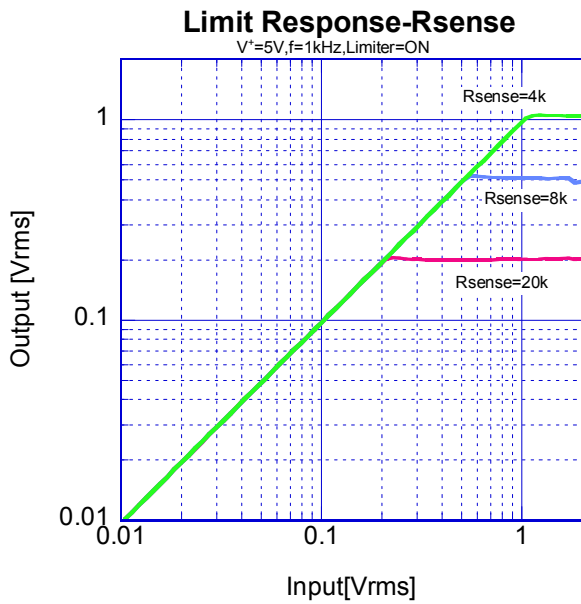
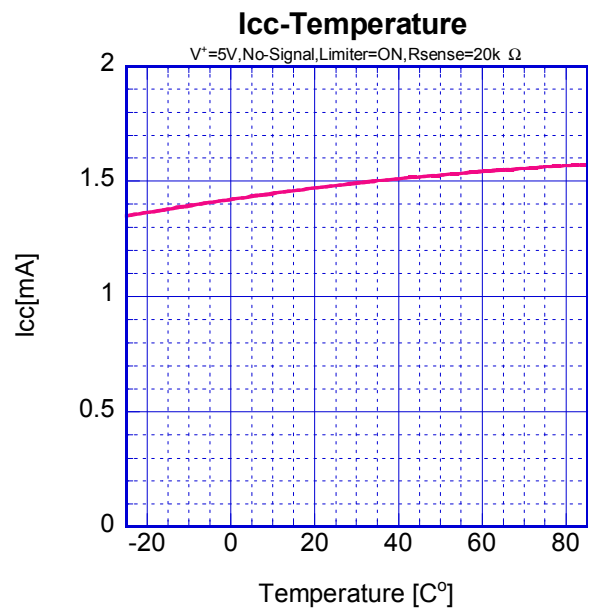
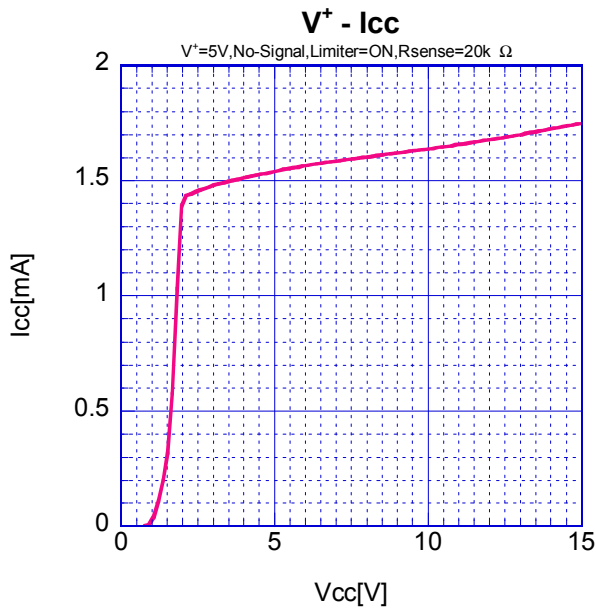

# NJM2761

## TYPICAL CHARACTERISTICS

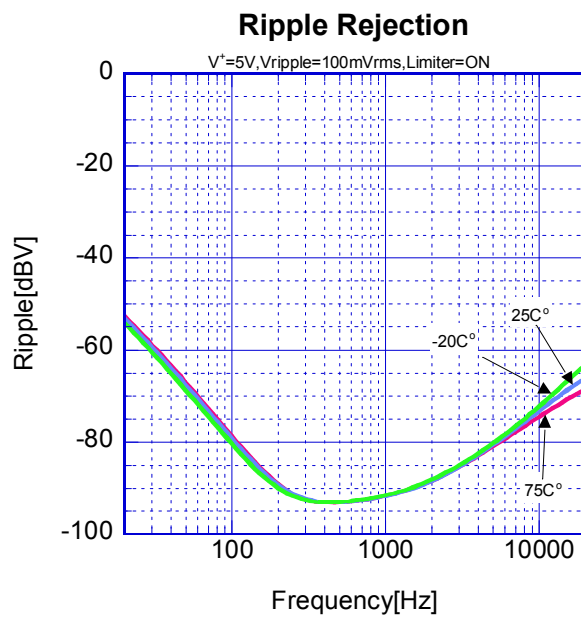
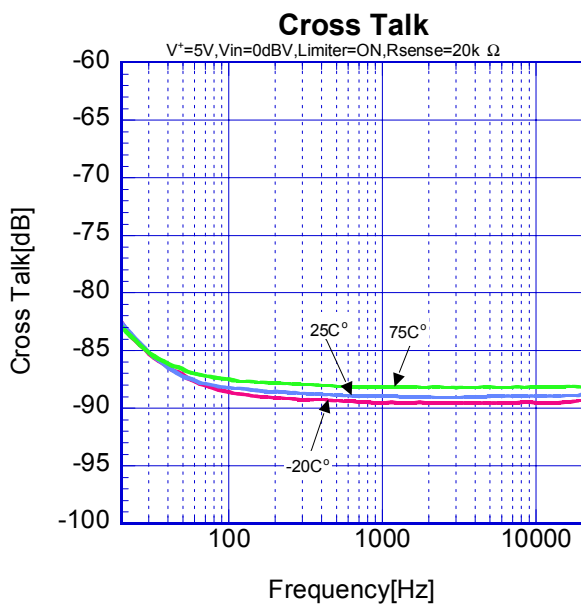
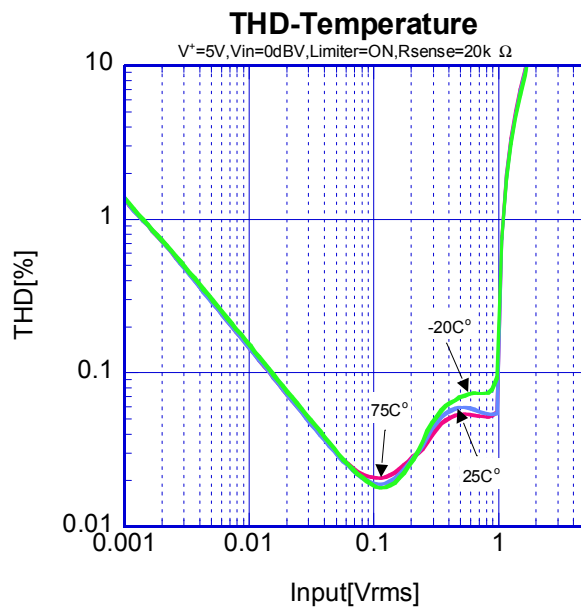
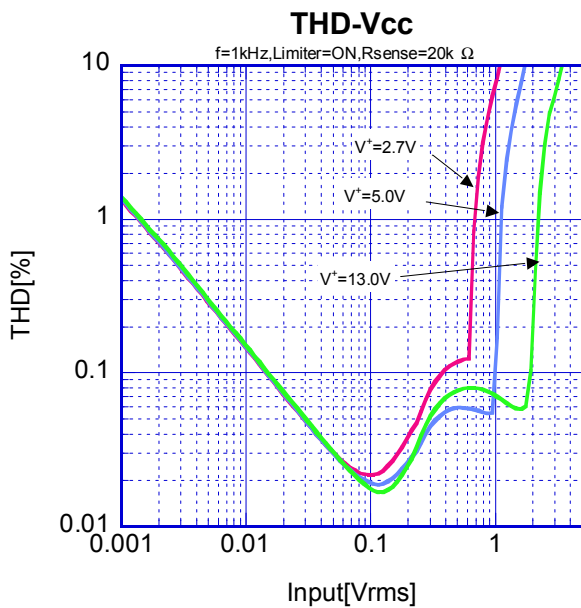

**[CAUTION]**  
 The specifications on this databook are only given for information, without any guarantee as regards either mistakes or omissions. The application circuits in this databook are described only to show representative usages of the product and not intended for the guarantee or permission of any right including the industrial rights.