

ADJUSTABLE LOW DROPOUT VOLTAGE REGULATOR WITH ON/OFF CONTROL

■ GENERAL DESCRIPTION

The NJM2387A is an adjustable low dropout voltage regulator. The output current is up to 1.0A and dropout voltage is 0.2V typ. at $I_o=0.5A$. OFF control quiescent current is drastically reduced compare with the current NJM2387 through changing ON/OFF control circuit. The NJM2387A is suitable for power module, TV, Display, car stereo and low power applications.

■ PACKAGE OUTLINE

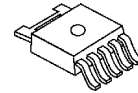

NJM2387ADL3

■ FEATURES

- Low Dropout Voltage $\Delta V_{I-O}=0.2V$ typ. at $I_o=0.5A$
- Output Current $I_o(\text{max.})=1.0A$
- Reference Voltage $V_{\text{ref}}=1.26V \pm 2\%$
- ON/OFF Control
- Internal Short Circuit Current Limit
- Internal Overvoltage Protection
- Internal Thermal Overload Protection
- Bipolar Technology
- Package Outline TO-252-5

■ PIN CONFIGURATION

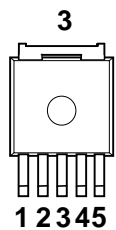

PIN FUNCTION

1. V_{IN}
2. ON/OFF CONTROL
3. V_{OUT}
4. V_{ADJ}
5. GND

NJM2387ADL3

■ EQUIVALENT CIRCUIT

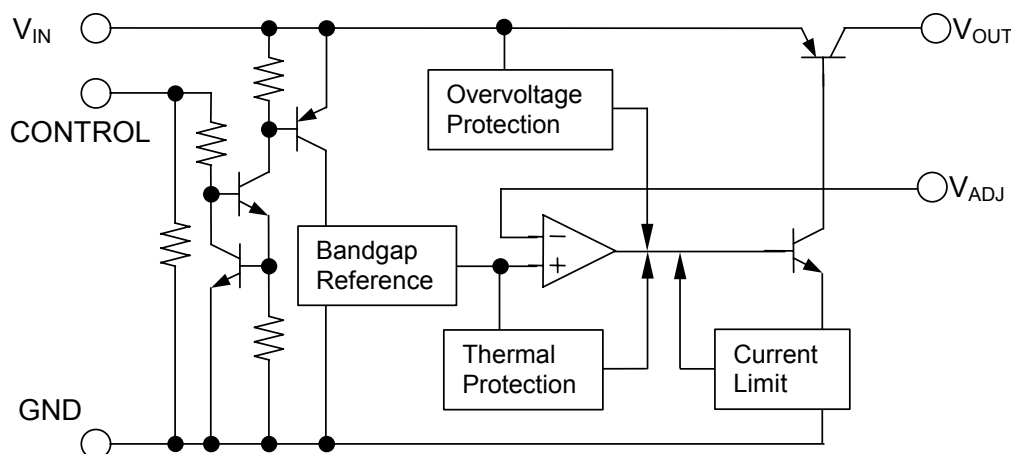

NJM2387ADL3

NJM2387A

■ ABSOLUTE MAXIMUM RATINGS

(Ta=25°C)

PARAMETER	SYMBOL	RATINGS	UNIT
Input Voltage	V _{IN}	+35	V
Control Voltage	V _{CONT}	+35(*1)	V
Adjust Terminal Voltage	V _{ADJ}	+6	V
Output Current	I _o	1.0	A
Power Dissipation	P _D	10(Tc≤25°C) / 1(Ta≤25°C)	W
Operating Junction Temperature Range	T _j	-40 ~ +150	°C
Operating Temperature Range	T _{opr}	-40 ~ +85	°C
Storage Temperature Range	T _{stg}	-50 ~ +150	°C

(*1): When input voltage is less than +35V, the absolute maximum control voltage is equal to the input voltage.

■ ELECTRICAL CHARACTERISTICS (V_{IN}=15V, V_O=10V, I_o=0.5A, R₁=1kΩ, C_{IN}=0.33μF, C_o=22μF, T_j=25°C)

Measurement is conducted by pulse testing.

PARAMETER	SYMBOL	CONDITIONS	MIN.	TYP.	MAX.	UNIT
Input Voltage	V _{IN}	-	3.8	-	30	V
Output Voltage	V _{O(ADJ)}	-	1.5	-	20	V
Reference Voltage	V _{ref}	-	1.235	1.26	1.285	V
Line Regulation	ΔV _o /ΔV _{IN}	V _{IN} =V _O +1V ~ V _O +17V	-	0.04	0.16	%/V
Load Regulation	ΔV _o /ΔI _o	V _{IN} =V _O +2V, I _o =0A ~ 1.0A	-	0.2	1.4	%/A
Average Temperature Coefficient of Output Voltage	ΔV _o /ΔT	T _j =0 ~ +125°C	-	± 0.02	-	%/°C
Quiescent Current	I _Q	I _o =0A, V _{CONT} =2.7V Except I _{CONT}	-	-	5	mA
OFF Control Quiescent Current	I _{Q(OFF)}	V _{CONT} =0V	-	-	1	μA
Dropout Voltage	ΔV _{LO}	I _o =0.5A	-	0.2	0.5	V
Ripple Rejection	RR	V _{in} =V _o +2V, e _{in} =0.5Vrms e _{in} =0.5Vrms, f=120Hz	52	65	-	dB
ON Control Voltage	V _{CONT(ON)}		2.0(*2)	-	-	V
OFF Control Voltage	V _{CONT(OFF)}		-	-	0.4	V
ON Control Current	I _{CONT(ON)}	V _C =2.7V	10	30	50	μA
OFF Control Current	I _{CONT(OFF)}	V _C =0.4V	1	3	5	μA

(*2): When ON/OFF CONTROL Terminal is open, Output Voltage is OFF.

TEST CIRCUIT

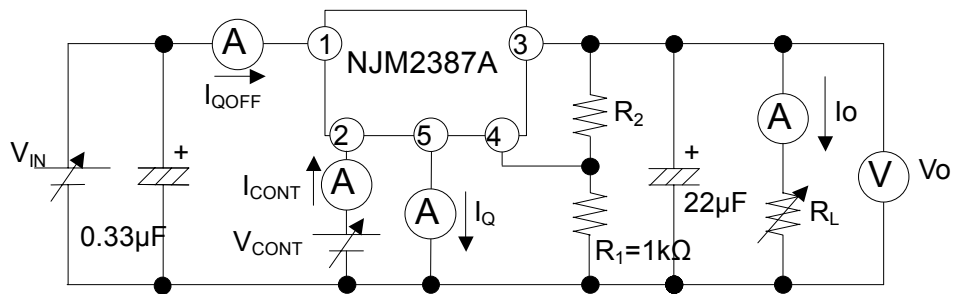

$$V_o = V_{ref} \times (1 + R_2/R_1)$$

TYPICAL APPLICATION

① In the case where ON/OFF Control is not required:

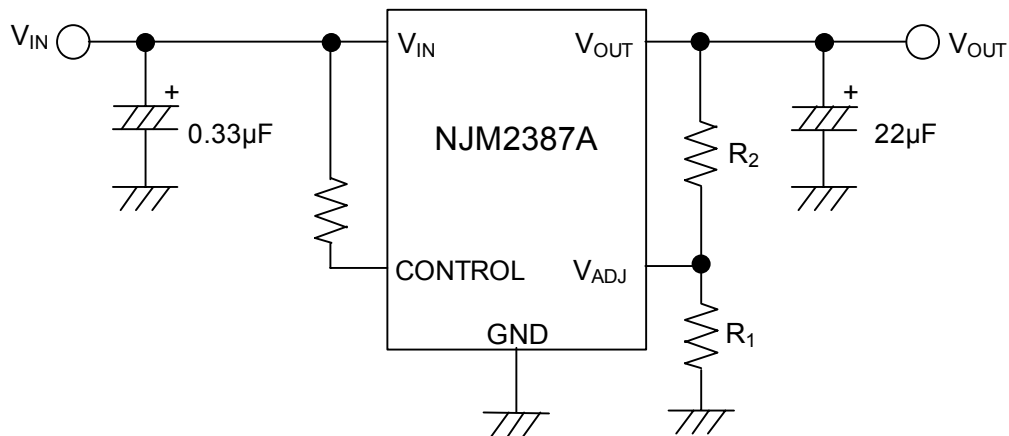

Connect control terminal to V_{IN} terminal.

The quiescent current can be reduced by using a resistance "R". Instead, it increases the minimum operating voltage. For further information, please refer to Figure "Output Voltage vs. Control Voltage".

② In use of ON/OFF CONTROL:

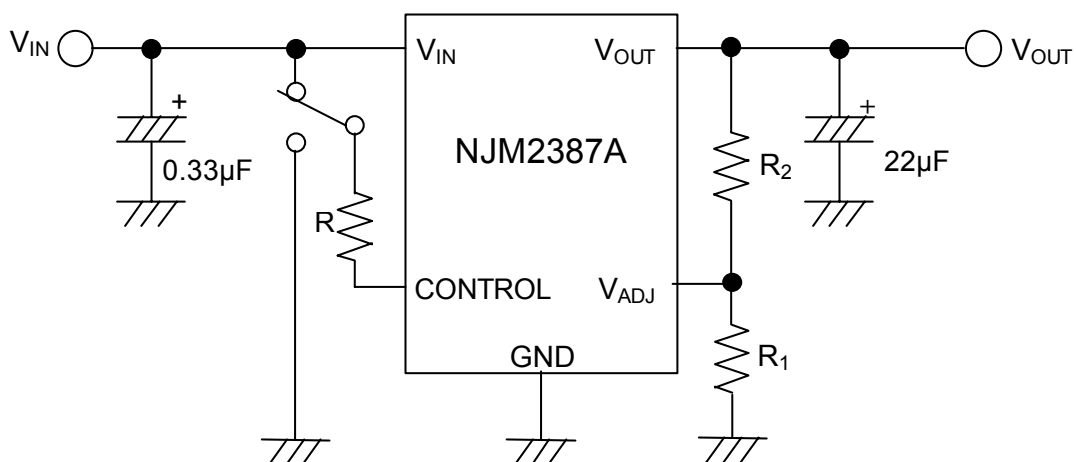

State of control terminal:

- "H" → output is enabled.
- "L" or "open" → output is disabled.

NJM2387A

ELECTRICAL CHARACTERISTICS

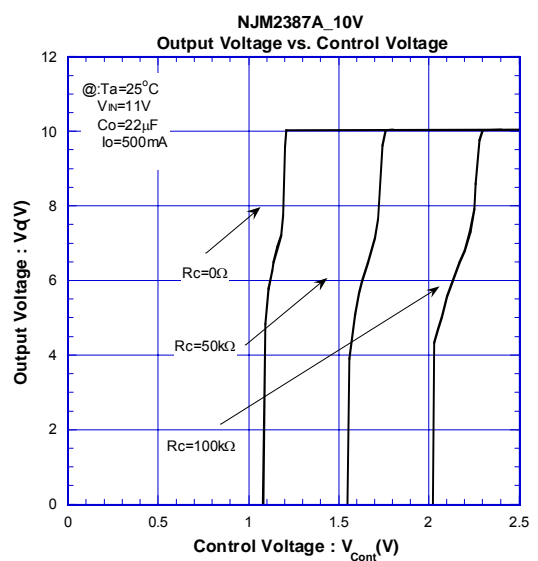
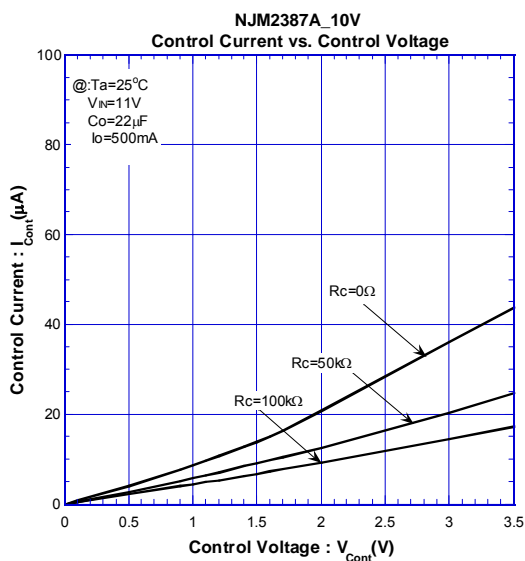
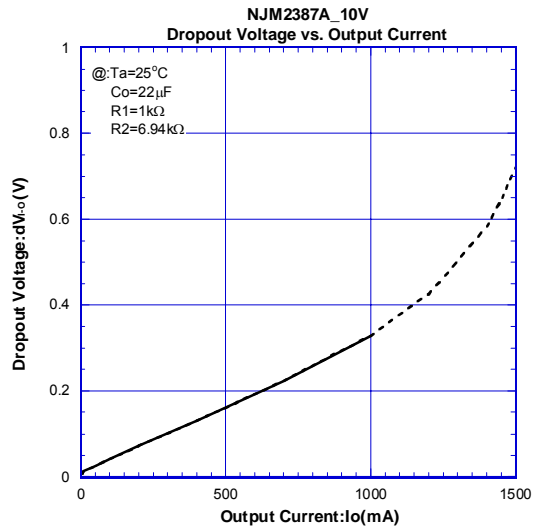
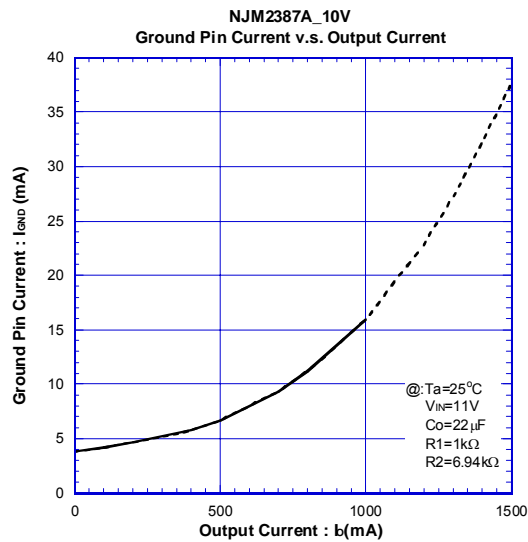
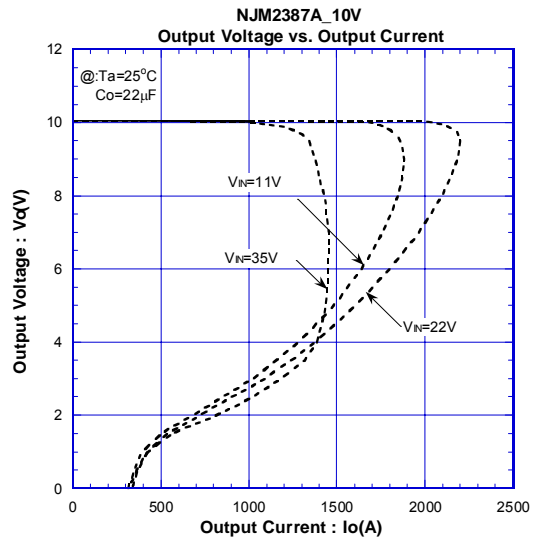
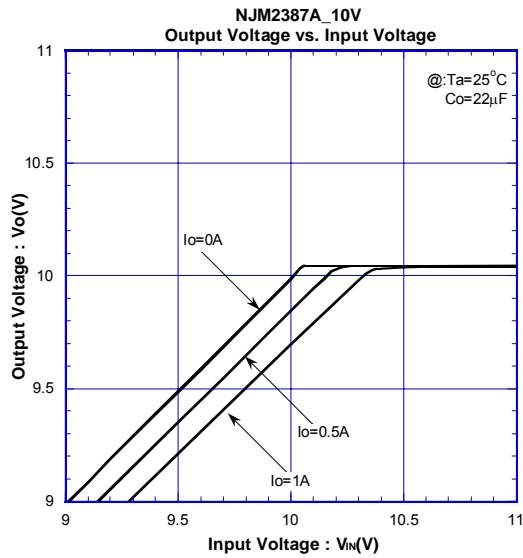

ELECTRICAL CHARACTERISTICS

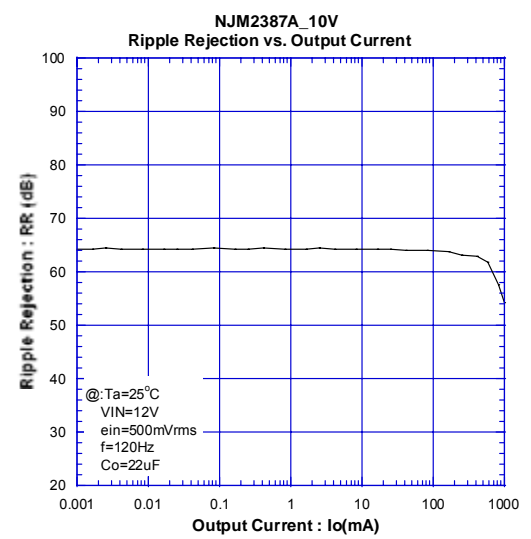
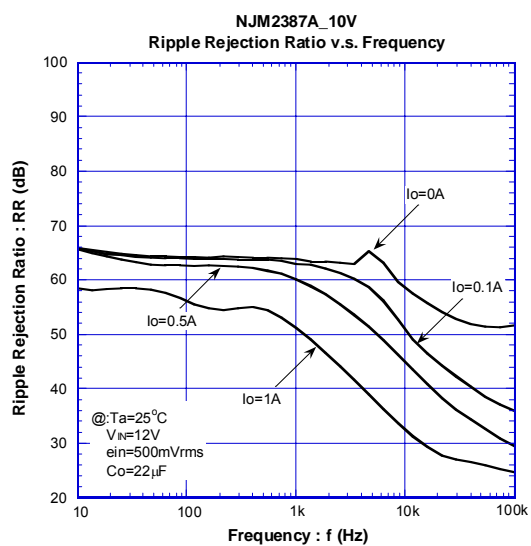
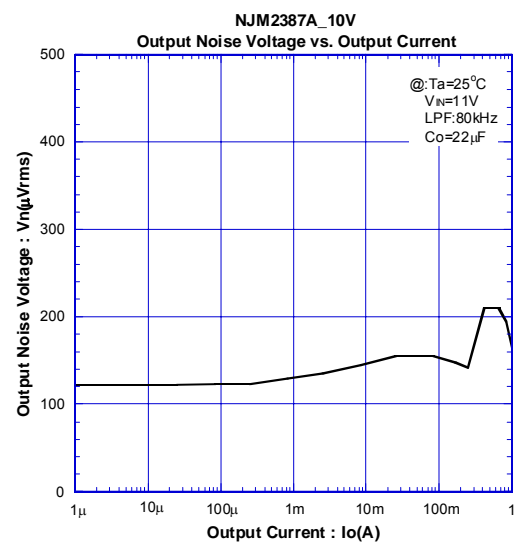
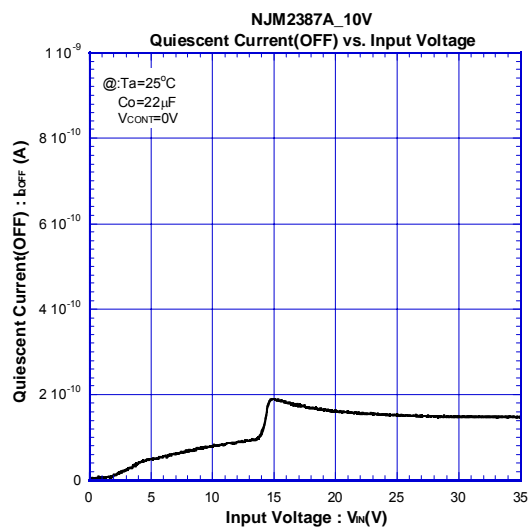
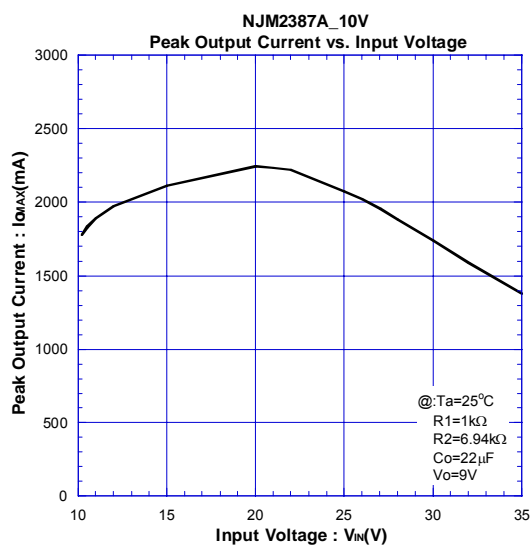
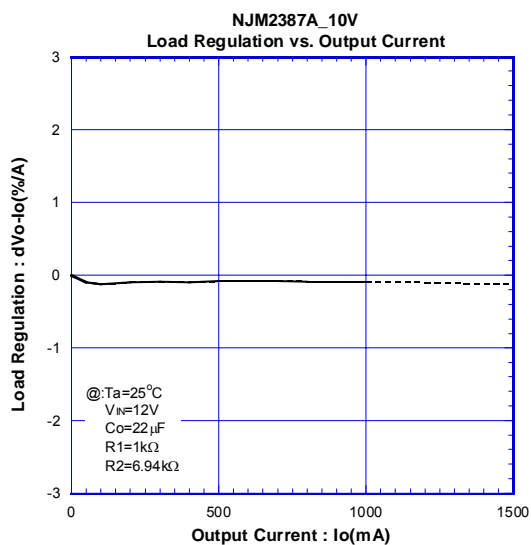

NJM2387A

ELECTRICAL CHARACTERISTICS

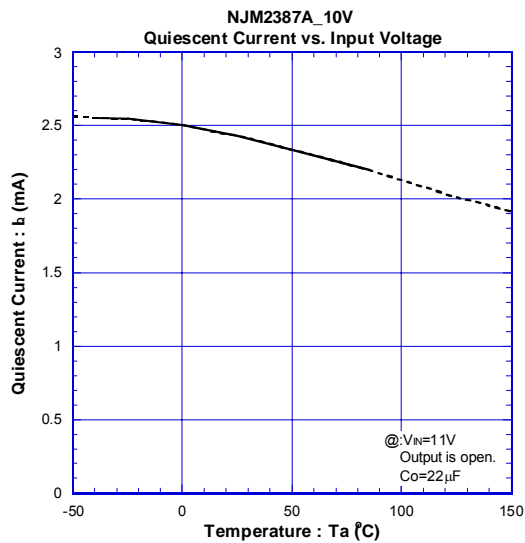
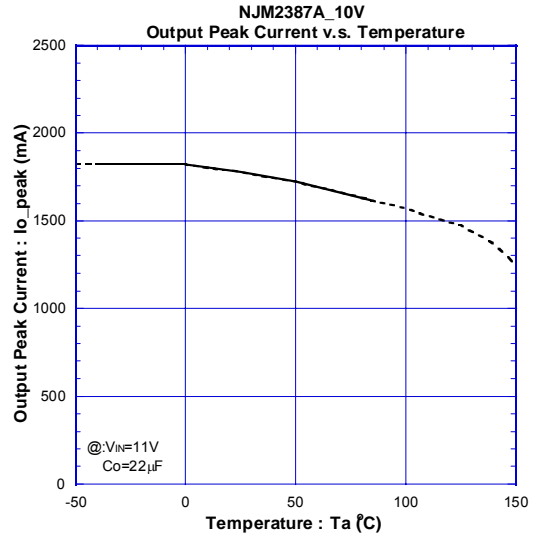
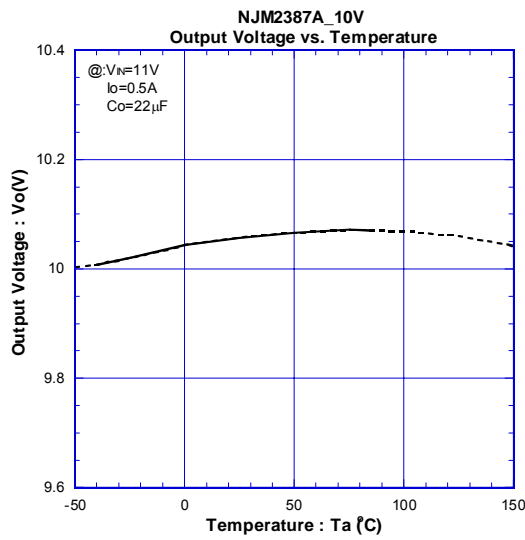
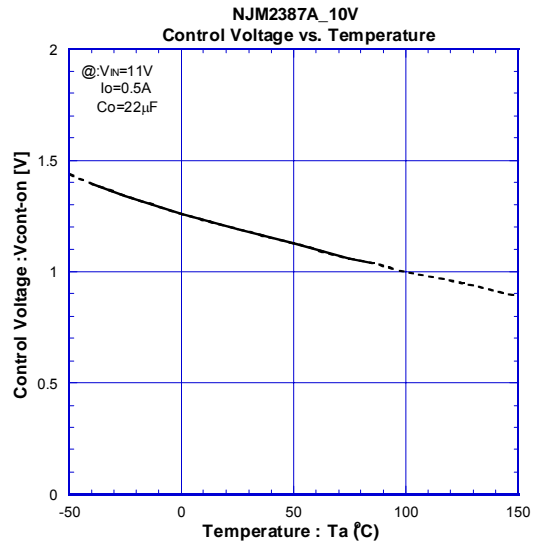
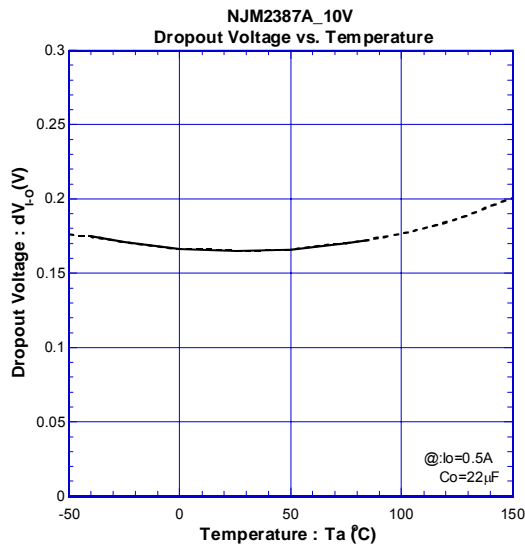

■ ELECTRICAL CHARACTERISTICS

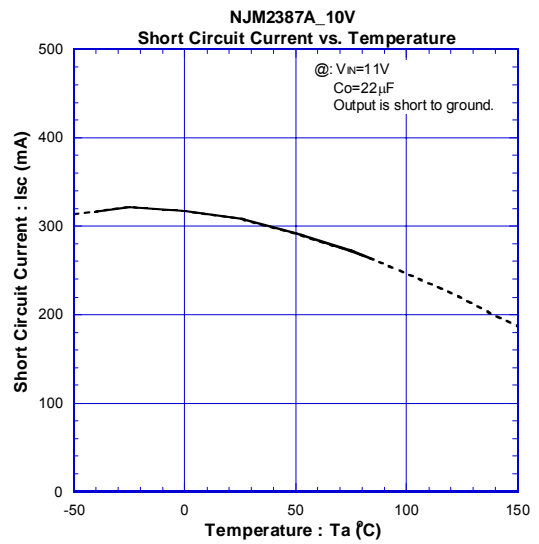
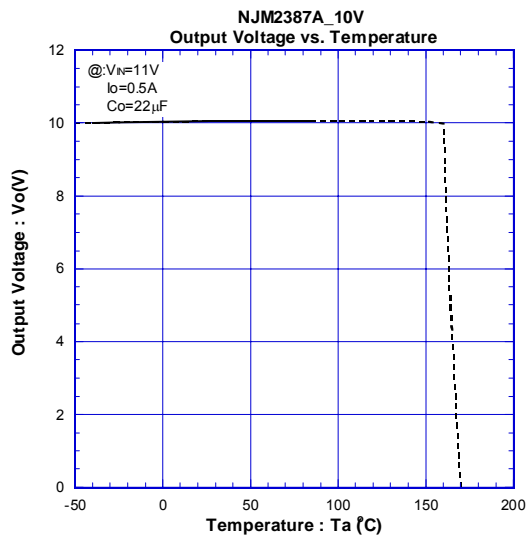
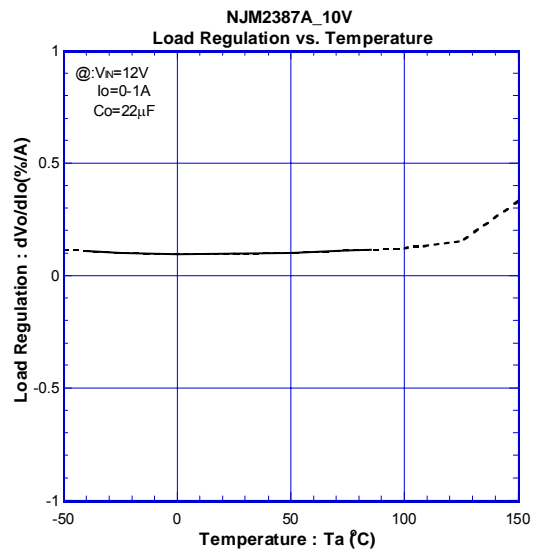
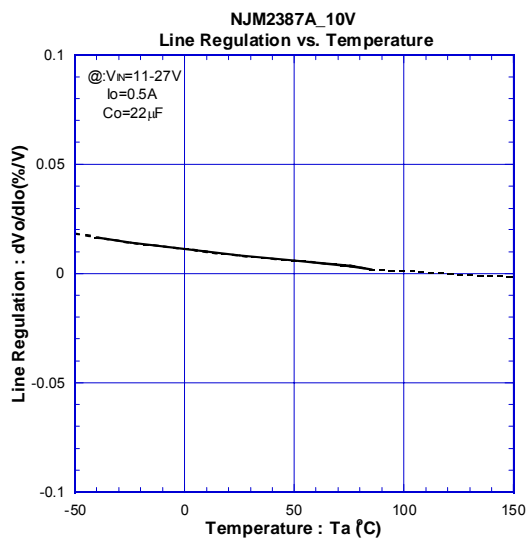

NJM2387A

■ ELECTRICAL CHARACTERISTICS

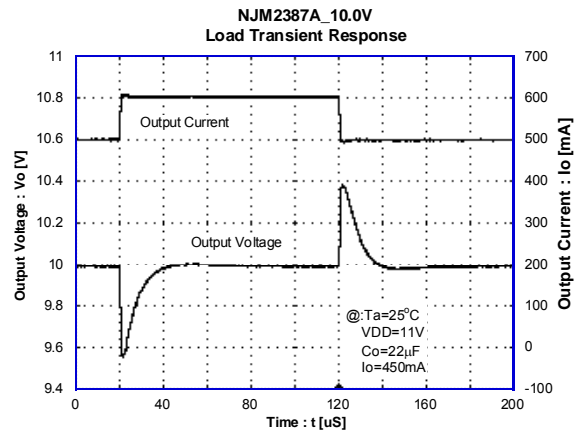
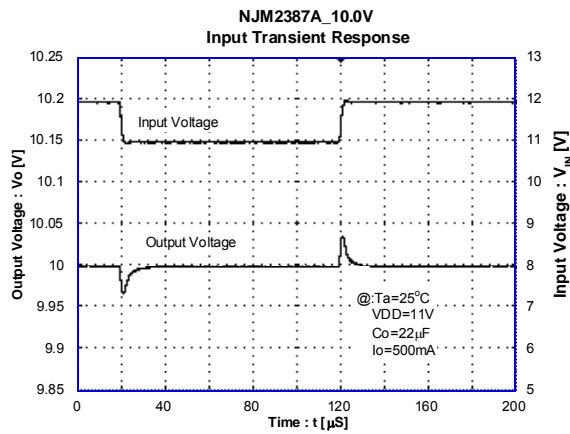
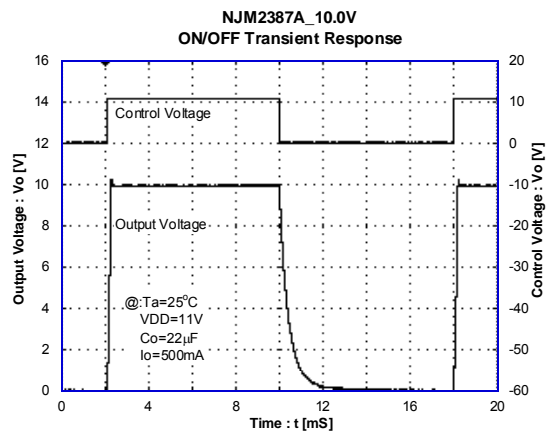
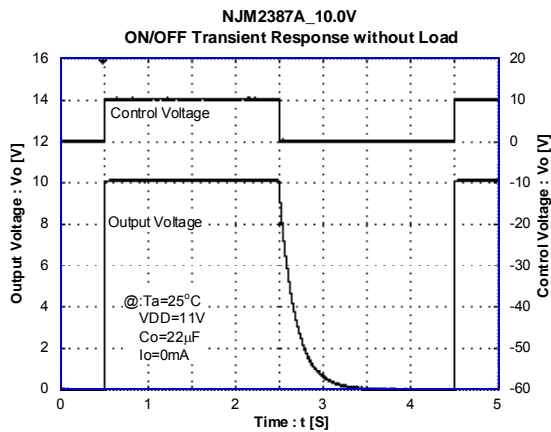

[CAUTION]
The specifications on this databook are only given for information, without any guarantee as regards either mistakes or omissions. The application circuits in this databook are described only to show representative usages of the product and not intended for the guarantee or permission of any right including the industrial rights.