

J-FET INPUT OPERATIONAL AMPLIFIER

■ GENERAL DESCRIPTION

The NJM2162/64 combines feature of the NJM062/064 as well as and providing the capability of wider bandwidth and higher slew rate.

It is suitable for telecom application (active filters etc.).

■ FEATURES

- Operating Voltage ($\pm 2V \sim \pm 18V$)
- High Input Resistance ($10^{12}\Omega$ typ.)
- Low Operating Current ($0.3mA/ch$ typ.)
- High Slew Rate ($10V/\mu s$ typ.)
- J-FET Input
- Wide Unity Gain Bandwidth ($3MHz$ typ.)
- Bipolar Technology
- Package Outline DIP8/14, DMP8/14, SIP8, SSOP8/14

■ PACKAGE OUTLINE

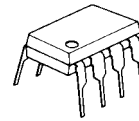

NJM2162D



NJM2162M

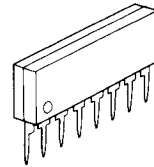

NJM2162L



NJM2162V

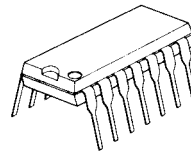

NJM2164D

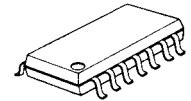

NJM2164M



NJM2164V

■ PIN CONFIGURATION

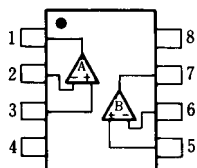

NJM2162D
NJM2162M
NJM2162V

- PIN FUNCTION**
- 1.A OUTPUT
 - 2.A -INPUT
 - 3.A +INPUT
 - 4.V⁺

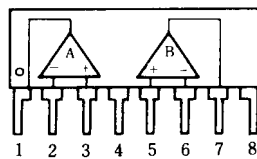

NJM2162L

- 5.B +INPUT
- 6.B -INPUT
- 7.B OUTPUT
- 8.V⁺

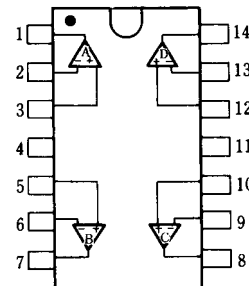

NJM2164D
NJM2164M
NJM2164V

- PIN FUNCTION**
- 1.A OUTPUT
 - 2.A -INPUT
 - 3.A +INPUT
 - 4.V⁺
 - 5.B +INPUT
 - 6.B -INPUT
 - 7.B OUTPUT
 - 8.C OUTPUT
 - 9.C -INPUT
 - 10.C +INPUT
 - 11.V⁻
 - 12.D +INPUT
 - 13.D -INPUT
 - 14.D OUTPUT

■ EQUIVALENT CIRCUIT (2162 is 1/2 Shown, 2164 is 1/4 Shown)

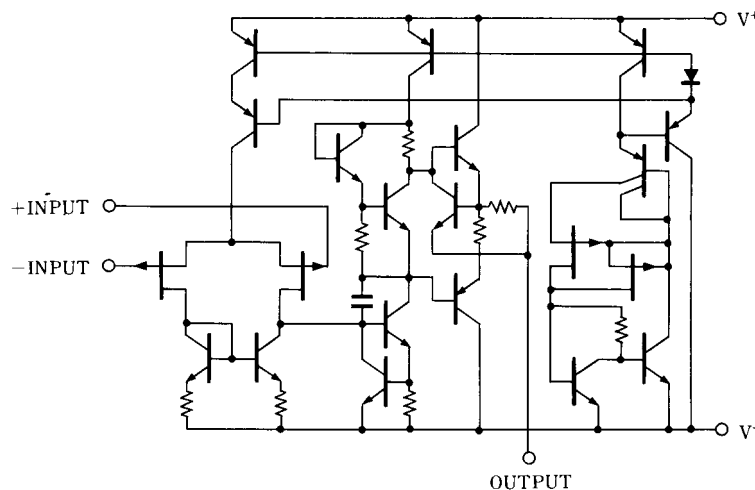

NJM2162/2164

■ ABSOLUTE MAXIMUM RATINGS

(Ta=25°C)

PARAMETER	SYMBOL	RATINGS	UNIT
Supply Voltage	V ⁺ /V	± 18	V
Differential Input Voltage	V _{ID}	± 30	V
Input Voltage	V _{IC}	± 15 (note1)	V
Power Dissipation	P _D	(DIP8) 500 (DMP8) 300 (SIP8) 800 (SSOP8) 250 (DIP14) 700 (DMP14) 700 (note2) (SSOP14) 300	mW
Operating Temperature Range	T _{opr}	-20~+75	°C
Storage Temperature Range	T _{stg}	-40~+125	°C

(note1) For supply voltage less than ±15V, the absolute maximum input voltage is equal to the supply voltage.

(note2) At on PC board

■ ELECTRICAL CHARACTERISTICS

(V⁺/V=±15V, Ta=25°C)

PARAMETER	SYMBOL	TEST CONDITION	MIN.	TYP.	MAX.	UNIT
Operating Voltage	V ⁺ /V		± 2	-	± 18	V
Input Offset Voltage	V _{IO}	R _S =50Ω	-	5	15	mV
Input Offset Current	I _{IO}		-	1	200	pA
Input Bias Current	I _B		-	2	400	pA
Input Common Mode Voltage Range	V _{ICM}		± 13	+15 -13.5	-	V
Maximum Output Voltage Swing	V _{OM}	R _L =10kΩ	± 13	+14 -14.0	-	V
Large Signal Voltage Gain	A _V	R _L ≥10kΩ, V _O =±10V	70	80	-	dB
Unity Gain Bandwidth	f _T	R _L =10Ω	-	3	-	MHz
Input Resistance	R _{IN}		-	10 ¹²	-	Ω
Common Mode Rejection Ratio	CMR	R _S ≤10kΩ	70	90	-	dB
Supply Voltage Rejection Ratio	SVR	R _S ≤10kΩ	70	100	-	dB
Operating Current	I _{CC}	R _L =∞ (1 circuit)	-	0.3	0.45	mA
Slew Rate	SR	R _L =10kΩ	-	10	-	V/μs
Equivalent Input Noise Voltage	e _n	R _S =100Ω, f=1kHz	-	40	-	nV/√Hz

(Note) The NJM2162/64 is the product in which the AC feature have been made much higher comparing to NJM062/64. Therefore special care being required for the oscillation due to the capacitive load when operation on voltage follower.

■ TYPICAL CHARACTERISTICS

Voltage Gain, Phase Shift vs. Frequency

($V^+/V^- = \pm 15V$, $Z_L = 10k\Omega // 100pF$, $T_a = 25^\circ C$)

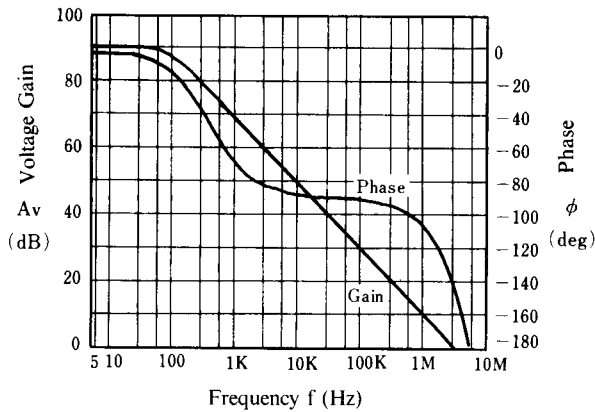

Maximum Output Voltage Swing vs. Frequency

($R_L = 10k\Omega$, $T_a = 25^\circ C$)

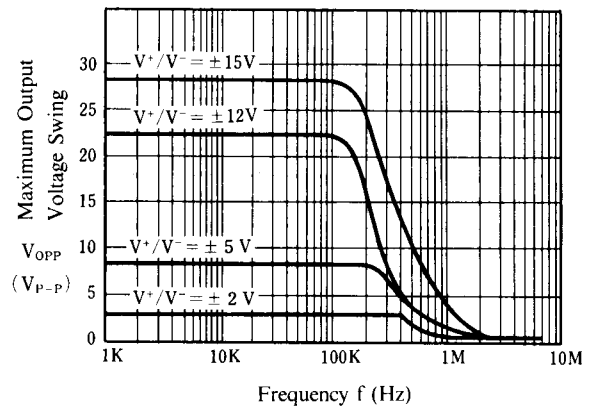

Maximum Output Voltage Swing vs. Load Resistance

($V^+/V^- = \pm 15V$, $T_a = 25^\circ C$)

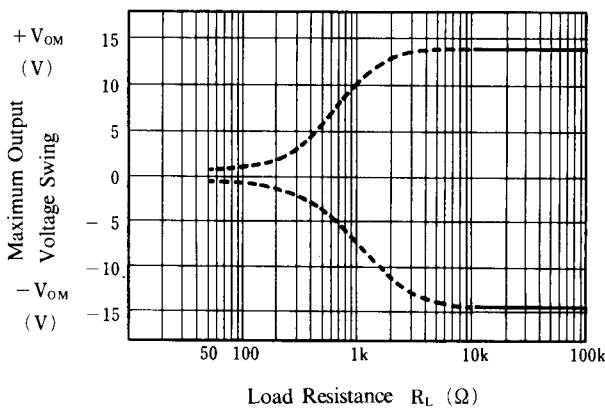

Maximum Output Voltage Swing vs. Output Current

($V^+/V^- = \pm 15V$, $T_a = 25^\circ C$)

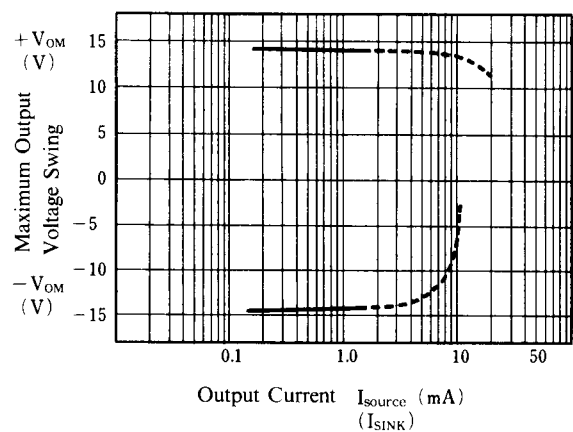

Equivalent Input Noise Voltage vs. Frequency

($V^+/V^- = \pm 15V$, $R_s = 100\Omega$, $T_a = 25^\circ C$)

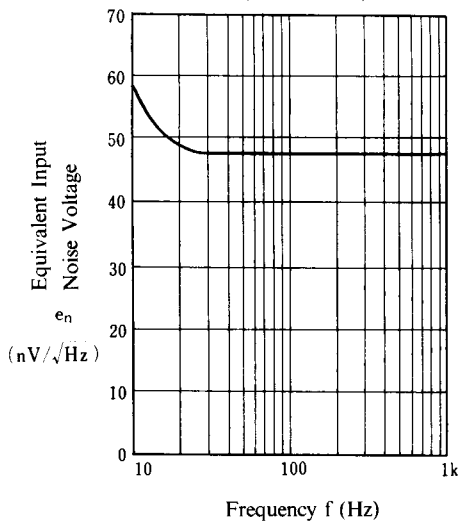

Voltage Follower Large Signal Pulse Response

($V^+/V^- = \pm 15V$, $R_L = 10k\Omega$, $C_L = 100pF$, $T_a = 25^\circ C$)

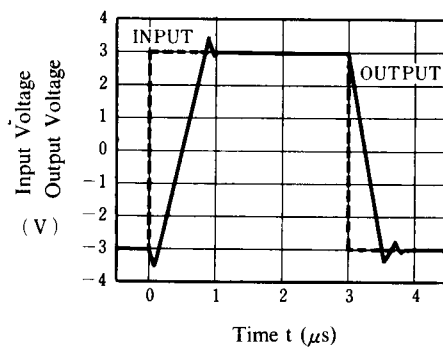

NJM2162/2164

■ TYPICAL CHARACTERISTICS

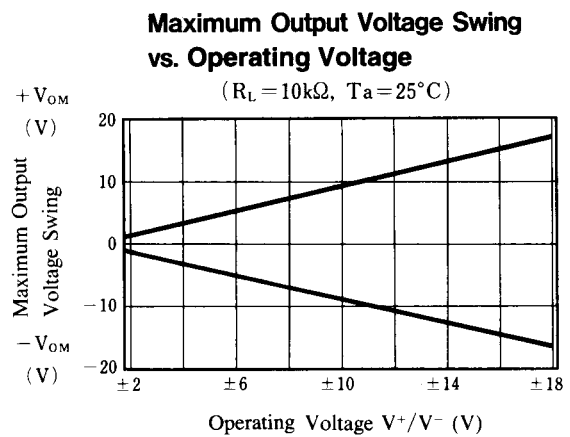
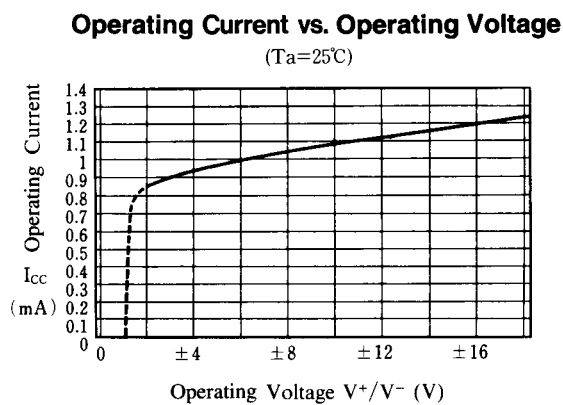
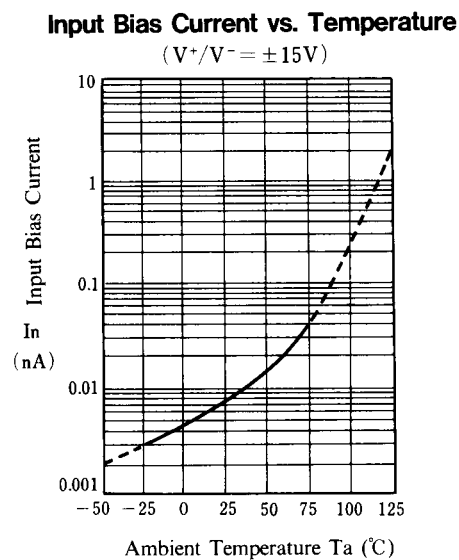
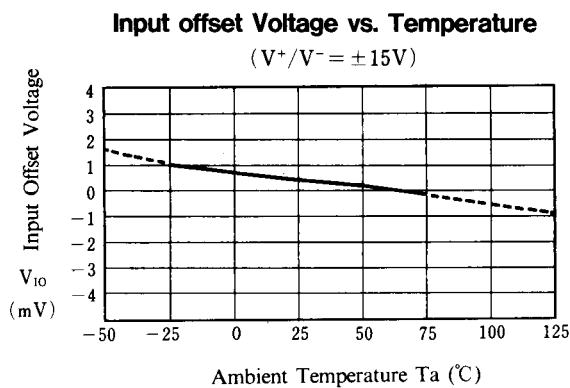
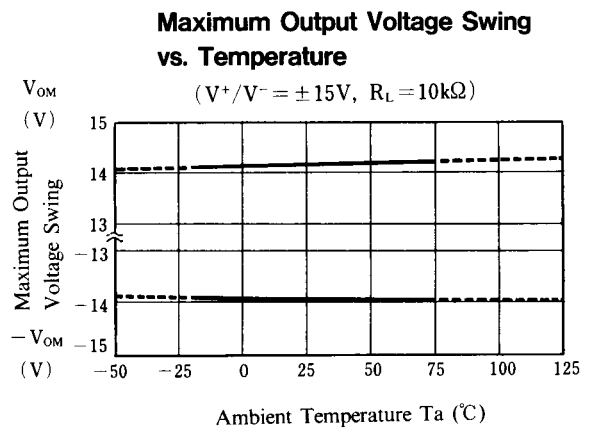
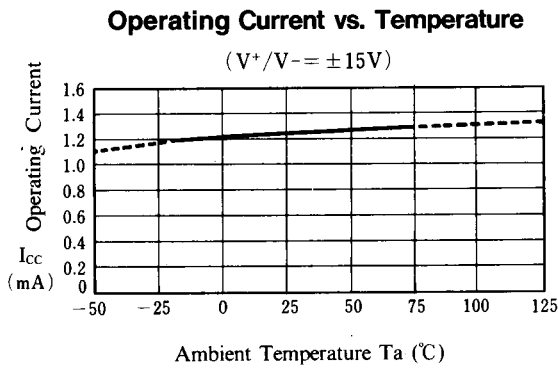

[CAUTION]

The specifications on this databook are only given for information, without any guarantee as regards either mistakes or omissions. The application circuits in this databook are described only to show representative usages of the product and not intended for the guarantee or permission of any right including the industrial rights.