

PRELIMINARY

NEC NEC LCD Technologies, Ltd.

Gleichmann & Co. Electronics GmbH
Product Marketing Displays & Systems
Industriestr. 16, D- 76297 Stutensee
Tel :07249-910-0, Fax: 07249-910-559
<http://www.msc-ge.com>

TFT COLOR LCD MODULE

NL10276BC30-17

38cm (15.0 Type)

XGA

LVDS interface (1port)

PRELIMINARY DATA SHEET 

DOD-PD-0568 (1st edition)

**All information is subject to change without notice.
Please confirm the sales representative before
starting to design your system.**

INTRODUCTION

No part of this document shall be copied in any form or by any means without the prior written consent of NEC Corporation.

NEC Corporation does not assume any liability for infringement of patents, copyrights or other intellectual property rights of third parties by or arising from use of a product described herein or any other liability arising from use of such application. No license, express, implied or otherwise, is granted under any patents, copyrights or other intellectual property rights of NEC Corporation or of others.

While NEC Corporation has been making continuous effort to enhance the reliability of its products, the possibility of failures cannot be eliminated entirely. To minimize risks of damage to property or injury to person arising from a failure in an NEC product, customers must incorporate sufficient safety measures in their design, such as redundancy, fire-containment and anti-failure features.

NEC products are classified into the following three quality grades:

"Standard", "Special", "Specific"

The *"Specific"* quality grade applies only to applications developed based on a customer designated "quality assurance program" for a specific application. The recommended applications of a product depend on its quality grade, as indicated below. Customers must check the quality grade of each application before using it in a particular application.

Standard: Computers, office equipment, communications equipment, test and measurement equipment, audio and visual equipment, home electronic appliances, machine tools, personal electronic equipment and industrial robots

Special: Transportation equipment (automobiles, trains, ships, etc.), traffic control systems, anti-disaster systems, anti-crime systems, safety equipment and medical equipment (not specifically designed for life support)

Specific: Military systems, aircraft, aerospace equipment, submersible repeaters, nuclear reactor control systems, life support systems (medical equipment, etc.) and any other equipment

The quality grade of this product is *"Standard"* unless otherwise specified in this document. If customers intend to use this product for applications other than those specified for *"Standard"* quality grade, they should contact NEC Corporation sales representative in advance.

CONTENTS

INTRODUCTION	2
1. OUTLINE.....	4
1.1 STRUCTURE AND PRINCIPLE.....	4
1.2 APPLICATIONS.....	4
1.3 FEATURES.....	4
2. GENERAL SPECIFICATIONS	5
3. BLOCK DIAGRAM.....	6
4. DETAILED SPECIFICATIONS	7
4.1 MECHANICAL SPECIFICATIONS.....	7
4.2 ABSOLUTE MAXIMUM RATINGS	7
4.3 ELECTRICAL CHARACTERISTICS.....	8
4.3.1 LCD panel signal processing board.....	8
4.3.2 Backlight lamp.....	9
4.3.3 Power supply voltage ripple.....	10
4.3.4 Fuse.....	10
4.4 POWER SUPPLY VOLTAGE SEQUENCE	11
4.5 CONNECTIONS AND FUNCTIONS FOR INTERFACE PINS.....	12
4.5.1 LCD panel signal processing board.....	12
4.5.2 Backlight lamp.....	13
4.5.3 Position of plug and socket.....	13
4.5.4 Connection between receiver and transmitter for LVDS	14
4.6 DISPLAY COLORS AND INPUT DATA SIGNALS	16
4.7 DISPLAY POSITIONS.....	17
4.8 SCANNING DIRECTIONS	17
4.9 INPUT SIGNAL TIMINGS.....	18
4.9.1 Outline of input signal timings	18
4.9.2 Timing characteristics.....	19
4.9.3 Input signal timing chart.....	20
4.10 OPTICS.....	21
4.10.1 Optical characteristics.....	21
4.10.2 Definition of contrast ratio.....	22
4.10.3 Definition of luminance uniformity	22
4.10.4 Definition of response times	22
4.10.5 Definition of viewing angles.....	22
5. RELIABILITY TESTS.....	23
6. PRECAUTIONS	24
6.1 MEANING OF CAUTION SIGNS	24
6.2 CAUTIONS	24
6.3 ATTENTIONS	24
6.3.1 Handling of the product.....	24
6.3.2 Environment.....	25
6.3.3 Characteristics.....	25
6.3.4 Other	25
7. OUTLINE DRAWINGS	26
7.1 FRONT VIEW	26
7.2 REAR VIEW	27
REVISION HISTORY	28

1. OUTLINE

1.1 STRUCTURE AND PRINCIPLE

Color LCD module NL10276BC30-17 is composed of the amorphous silicon thin film transistor liquid crystal display (a-Si TFT LCD) panel structure with driver LSIs for driving the TFT (Thin Film Transistor) array and a backlight.

The a-Si TFT LCD panel structure is injected liquid crystal material into a narrow gap between the TFT array glass substrate and a color-filter glass substrate.

Color (Red, Green, Blue) data signals from a host system (e.g. PC, signal generator, etc.) are modulated into best form for active matrix system by a signal processing board, and sent to the driver LSIs which drive the individual TFT arrays.

The TFT array as an electro-optical switch regulates the amount of transmitted light from the backlight assembly, when it is controlled by data signals. Color images are created by regulating the amount of transmitted light through the TFT array of red, green and blue dots.

1.2 APPLICATIONS

- For industrial use

1.3 FEATURES

- Ultra-wide viewing angle (Adoption of Super Advanced -Super Fine TFT (SA-SFT))
- LVDS interface (8-bit)
- Selectable LVDS input map
- Wide color gamut
- High contrast
- Small foot print
- Edge light type backlight (without inverter)
- Replaceable lamp for backlight

2. GENERAL SPECIFICATIONS

Display area	304.128 (H) × 228.096 (V) mm
Diagonal size of display	38.0 cm (15.0 inches)
Drive system	a-Si TFT active matrix
Display color	16,777,216 colors (6bit+FRC)
Pixel	1,024 (H) × 768 (V) pixels
Pixel arrangement	RGB (Red dot, Green dot, Blue dot) vertical stripe
Dot pitch	0.099 (H) × 0.297 (V) mm
Pixel pitch	0.297 (H) × 0.297 (V) mm
Module size	326.5 (typ., W) × 253.5 (typ., H) × 17.0 (max., D) mm
Weight	TBD g (typ.)
Contrast ratio	(450):1 (typ.)
Viewing angle	At the contrast ratio $\geq 10:1$ <ul style="list-style-type: none"> • Horizontal: Right side 85° (typ.), Left side 85° (typ.) • Vertical: Up side 85° (typ.), Down side 85° (typ.)
Designed viewing direction	Viewing angle with optimum grayscale ($\gamma=2.2$): normal axis (perpendicular)
Polarizer surface	Antiglare
Polarizer pencil-hardness	TBD H (min.) [by JIS K5600]
Color gamut	At LCD panel center 72 % (typ.) [against NTSC color space]
Response time	$T_{on} + T_{off}$ (10% ← → 90%) (25) ms (typ.)
Luminance	At $IBL=(6.0)mArms / lamp$ (300) cd/m^2 (typ.)
Signal system	LVDS 1port (Receiver: Equivalent of THC63LVDF84A, THine Electronics Inc.) [8-bit digital signals for data of RGB colors, Dot clock (CLK), Data enable (DE)]
Power supply voltage	LCD panel signal processing board: 3.3V
Backlight	Edge light type: 4 cold cathode fluorescent lamps (without inverter) { Replaceable part <ul style="list-style-type: none"> • Lamp holder set: Type No. TBD }
Power consumption	At $IBL=(6.0)mArms / lamp$ and checkered flag pattern TBD W (typ., Power dissipation of the inverter does not include.)

3. BLOCK DIAGRAM

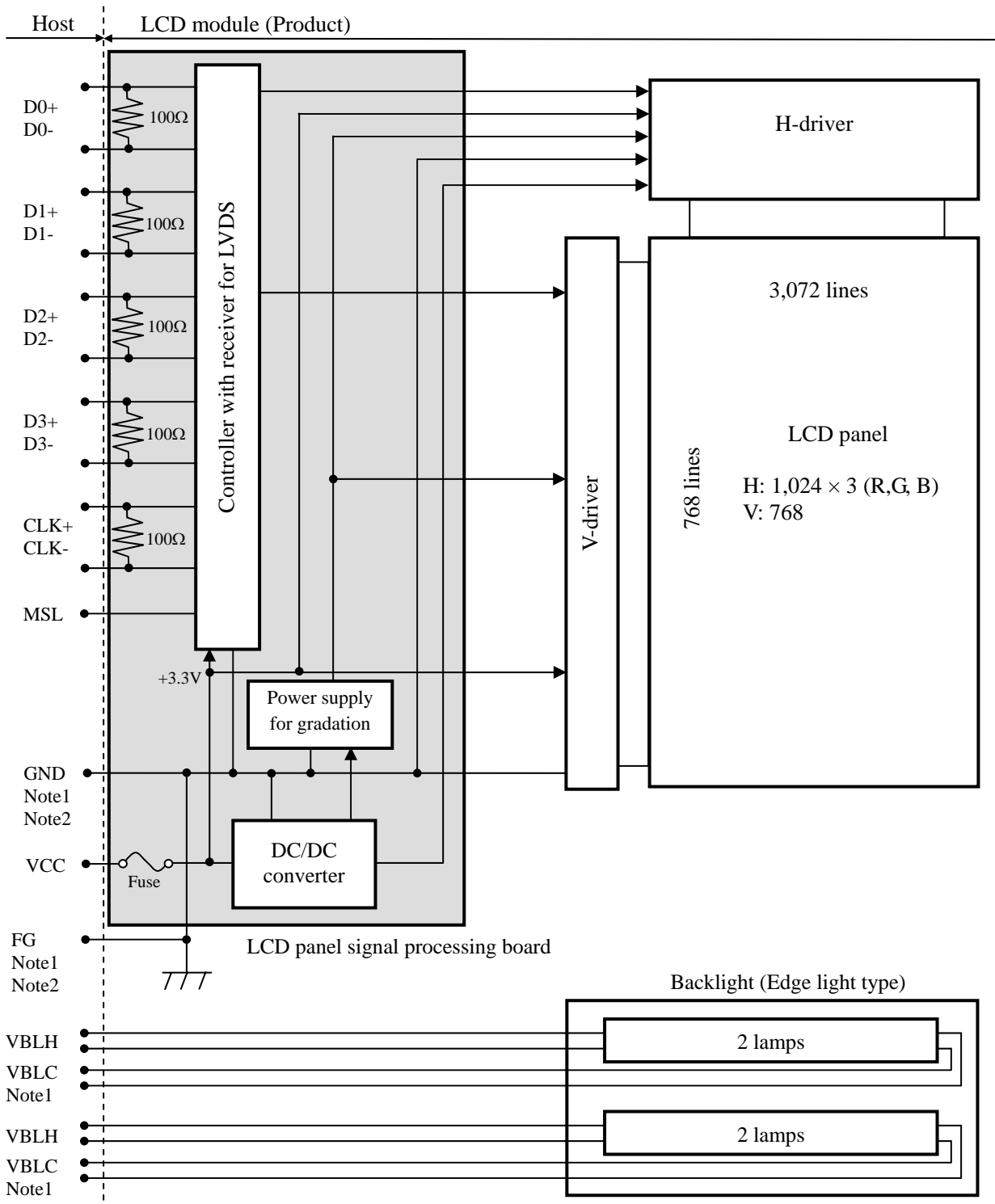

Note1: Connections between GND (Signal ground), FG (Frame ground) and VBLC (Lamp low voltage terminal) in the product

GND - FG	Connected
GND - VBLC	Not connected
FG - VBLC	Not connected

Note2: GND and FG must be connected to customer equipment's ground, and it is recommended that GND, FG and customer inverter ground are connected together in customer equipment.

PRELIMINARY

4. DETAILED SPECIFICATIONS

4.1 MECHANICAL SPECIFICATIONS

Parameter	Specification	Unit
Module size	326.5 ± 0.5 (W) × 253.5 ± 0.5 (H) × 17.0 max. (D)	Note1, Note2 mm
Display area	304.128 (H) × 228.096 (V)	Note1 mm
Weight	TBD (typ.), TBD (max.)	g

Note1: Excluding lamp cables.

Note2: See "7. OUTLINE DRAWINGS".

4.2 ABSOLUTE MAXIMUM RATINGS

Parameter		Symbol	Rating	Unit	Remarks
Power supply voltage	LCD panel signal processing board	VCC	(-0.3 to +3.6)	V	Ta = 25°C
	Lamp voltage	VBLH	TBD	Vrms	
Input voltage for signals	Display signals Note1	VD	(-0.3 to +3.6) and <VCC +0.3	V	Ta = 25°C
	Function signals Note2	VF			
Storage temperature		Tst	-20 to +60	°C	-
Operating temperature	Front surface	TopF	0 to +55	°C	Note3
	Rear surface	TopR	TBD	°C	Note4
Relative humidity Note5		RH	≤ 95	%	Ta ≤ 40°C
			≤ 85	%	40 < Ta ≤ 50°C
			≤ 70	%	50 < Ta ≤ 55°C
Absolute humidity Note5		AH	≤ 73 Note6	g/m ³	Ta > 55°C
Operating altitude		-	≤ (4,850)	m	0°C ≤ Ta ≤ 55°C
Storage altitude		-	≤ (13,600)	m	-20°C ≤ Ta ≤ 60°C

Note1: Display signals are D0+/-, D1+/-, D2+/-, D3+/- and CK+/-.

Note2: Function signal is MSL.

Note3: Measured at center of LCD panel surface (including self-heat)

Note4: Measured at center of LCD module's rear shield surface (including self-heat)

Note5: No condensation

Note6: Water amount at Ta = 55°C and RH = 70%

PRELIMINARY

4.3 ELECTRICAL CHARACTERISTICS

4.3.1 LCD panel signal processing board

(Ta = 25°C)

Parameter	Symbol	min.	typ.	max.	Unit	Remarks	
Power supply voltage	VCC	3.0	3.3	3.6	V	-	
Power supply current	ICC	-	TBD Note1	TBD Note2	mA	at VCC = 3.3V	
Permissible ripple voltage	VRP	-	-	100	mVp-p	for VCC	
Differential input threshold voltage for LVDS receiver	High	VTH	-	-	+100	mV	at VCM=1.2V Note3
	Low	VTL	-100	-	-	mV	
Input voltage swing for LVDS receiver	Vi	0	-	2.4	V	-	
Terminating resistance	RT	-	100	-	Ω	-	
Input voltage for MSL signal	High	VFH	2.0	-	VCC	V	-
	Low	VFL	0	-	0.8	V	

Note1: Checkered flag pattern [by EIAJ ED-2522]

Note2: Pattern for maximum current

Note3: Common mode voltage for LVDS receiver

PRELIMINARY

4.3.2 Backlight lamp

(Ta=25°C, Note1)

Parameter	Symbol	min.	typ.	max.	Unit	Remarks
Lamp current	IBL	TBD	(6.0)	TBD	mArms	at IBL=(6.0)mArms: L=(300)cd/m ² (typ.) Note3
Lamp voltage	VBLH	-	(650)	-	Vrms	Note2, Note3
Lamp starting voltage	VS	TBD	-	-	Vrms	Ta = 0°C Note2, Note3
		TBD	-	-	Vrms	Ta = 25°C Note2, Note3
Lamp oscillation frequency	FO	TBD	(54)	TBD	kHz	Note4

Note1: This product consists of 4 backlight lamps, and these specifications are for each lamp.

Note2: The lamp voltage cycle between lamps should be kept on a same phase. "VS" and "VBLH" are the voltage value between low voltage side (Cold) and high voltage side (Hot).

Note3: The asymmetric ratio of working waveform for lamps (Lamp voltage peak ratio, Lamp current peak ratio and waveform space ratio) should be less than 5 % (See the following figure.). If the waveform is asymmetric, DC (Direct current) element apply into the lamp. In this case, a lamp lifetime may be shortened, because a distribution of a lamp enclosure substance inclines toward one side between low voltage terminal (Cold terminal) and high voltage terminal (Hot terminal).

When designing the backlight inverter, evaluate asymmetric of lamp working waveform sufficiently.

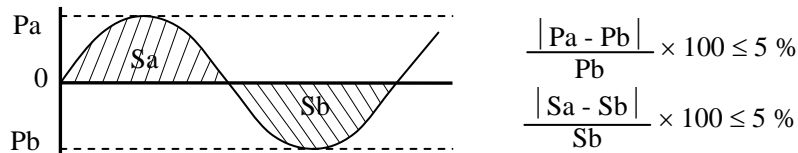

Pa: Supply voltage/current peak for positive, Pb: Supply voltage/current peak for negative
Sa: Waveform space for positive part, Sb: Waveform space for negative part

Note4: In case "FO" is not the recommended value, beat noise may display on the screen, because of interference between "FO" and "1/th". Recommended value of "FO" is as following.

$$FO = \frac{1}{4} \times \frac{1}{th} \times (2n-1)$$

th: Horizontal signal period (See "4.9.2 Timing characteristics".)

n: Natural number (1, 2, 3)

Note5: Method of lamp cable installation may invite fluctuation of lamp current and voltage or asymmetric of lamp working waveform. When designing method of lamp cable installation, evaluate the fluctuation of lamp current, voltage and working waveform sufficiently.

4.3.3 Power supply voltage ripple

This product works, even if the ripple voltage levels are beyond the permissible values as following the table, but there might be noise on the display image.

Power supply voltage		Ripple voltage (Measure at input terminal of power supply)	Note1	Unit
VCC	3.3 V	≤ 100		mVp-p

Note1: The permissible ripple voltage includes spike noise.

4.3.4 Fuse

Parameter	Fuse		Rating	Fusing current	Remarks
	Type	Supplier			
VCC	TBD	TBD	TBD	TBD	Note1
			TBD		

Note1: The power supply capacity should be more than the fusing current. If the power supply capacity is less than the fusing current, the fuse may not blow for a short time, and then nasty smell, smoking and so on may occur.

4.4 POWER SUPPLY VOLTAGE SEQUENCE

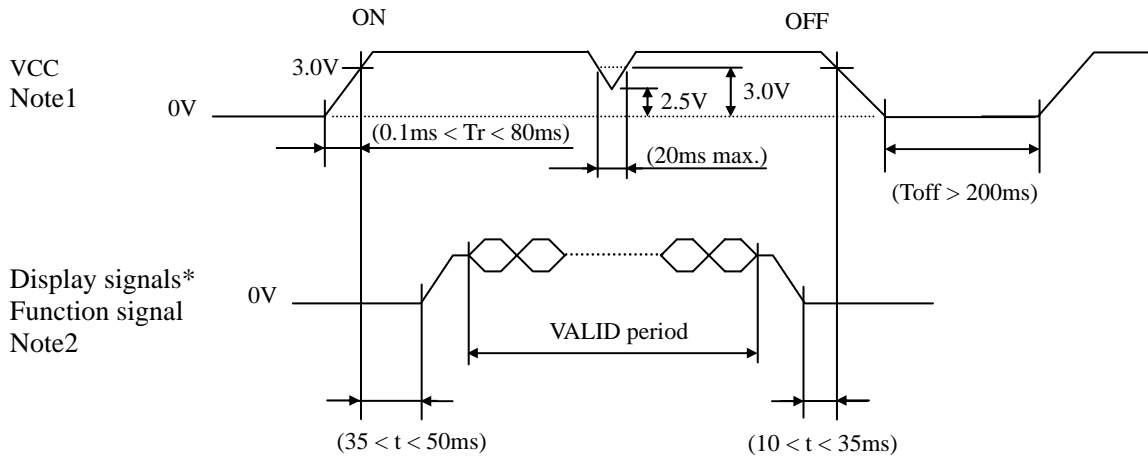

* These signals should be measured at the terminal of 100Ω resistance.

Note1: In terms of voltage variation (voltage drop) while VCC rising edge is below 3.0V, a protection circuit may work, and then this product may not work.

Note2: Display signals (D0+/-, D1+/-, D2+/-, D3+/- and CK+/-) and function signal (MSL) must be "0" voltage, exclude the VALID period (See above sequence diagram). If these signals are higher than 0.3V, the internal circuit is damaged.

If some of display and function signals of this product are cut while this product is working, even if the signal input to it once again, it might not work normally. If customer stops the display and function signals, they should be cut VCC.

Note3: VCC should be 3.0V or more while VCC ON period.

Note4: The backlight power supply voltage should be inputted within the valid period of display and function signals, in order to avoid unstable data display.

4.5 CONNECTIONS AND FUNCTIONS FOR INTERFACE PINS

4.5.1 LCD panel signal processing board

CN1 socket (LCD module side): DF-14H-20P-1.25H (Hirose Electric Co., Ltd. (HRS))

Adaptable plug: DF14-20S-1.25C (Hirose Electric Co., Ltd. (HRS))

Pin No.	Symbol	Signal	Remarks
1	VCC	Power supply	Note1
2	VCC		
3	GND	Ground	Note1
4	GND		
5	D0-	Pixel data	Note2
6	D0+		
7	GND	Ground	Note1
8	D1-	Pixel data	Note2
9	D1+		
10	GND	Ground	Note1
11	D2-	Pixel data	Note2
12	D2+		
13	GND	Ground	Note1
14	CLK-	Pixel clock	Note2
15	CLK+		
16	GND	Ground	Note1
17	D3-	Pixel data	Note2
18	D3+		
19	GND	Ground	Note1
20	MSL	Selection of LVDS input map Note3	High: Input map A Low or Open: Input map B

Note1: All GND and VCC terminals should be used without any non-connected lines.

Note2: Twist pair wires with 100Ω (Characteristic impedance) should be connected between LCD panel signal processing board and LVDS transmitter.

Note3: See "**4.5.4 Connection between receiver and transmitter for LVDS**".

PRELIMINARY

4.5.2 Backlight lamp

Attention: VBLH and VBLC must be connected correctly. If customer connects wrongly, customer will be hurt and the product will be broken.

CN201 plug (LCD module side): BHR-03VS-1 (J.S.T Mfg. Co., Ltd.)

Adaptable socket: SM02(8.0)B-BHS-1-TB (J.S.T Mfg. Co., Ltd.)

Pin No.	Symbol	Signal	Remarks
1	VBLH	High voltage terminal (Hot)	Cable color: (Pink)
2	N.C.	-	Keep this pin Open.
3	VBLC	Low voltage terminal (Cold)	Cable color: (White)

CN202 plug (LCD module side): BHR-03VS-1 (J.S.T Mfg. Co., Ltd.)

Adaptable socket: SM02(8.0)B-BHS-1-TB (J.S.T Mfg. Co., Ltd.)

Pin No.	Symbol	Signal	Remarks
1	VBLH	High voltage terminal (Hot)	Cable color: (Pink)
2	N.C.	-	Keep this pin Open.
3	VBLC	Low voltage terminal (Cold)	Cable color: (White)

CN203 plug (LCD module side): BHR-03VS-1 (J.S.T Mfg. Co., Ltd.)

Adaptable socket: SM02(8.0)B-BHS-1-TB (J.S.T Mfg. Co., Ltd.)

Pin No.	Symbol	Signal	Remarks
1	VBLH	High voltage terminal (Hot)	Cable color: (Pink)
2	N.C.	-	Keep this pin Open.
3	VBLC	Low voltage terminal (Cold)	Cable color: (White)

CN204 plug (LCD module side): BHR-03VS-1 (J.S.T Mfg. Co., Ltd.)

Adaptable socket: SM02(8.0)B-BHS-1-TB (J.S.T Mfg. Co., Ltd.)

Pin No.	Symbol	Signal	Remarks
1	VBLH	High voltage terminal (Hot)	Cable color: (Pink)
2	N.C.	-	Keep this pin Open.
3	VBLC	Low voltage terminal (Cold)	Cable color: (White)

4.5.3 Position of plug and socket

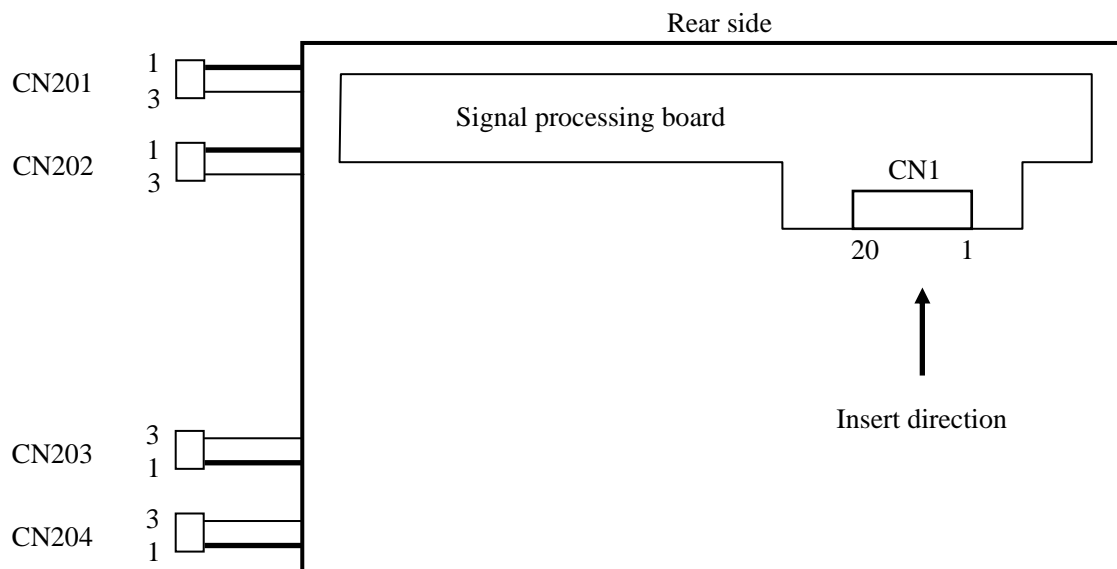

4.5.4 Connection between receiver and transmitter for LVDS
 (1) Input LVDS map A (MSL: "High")

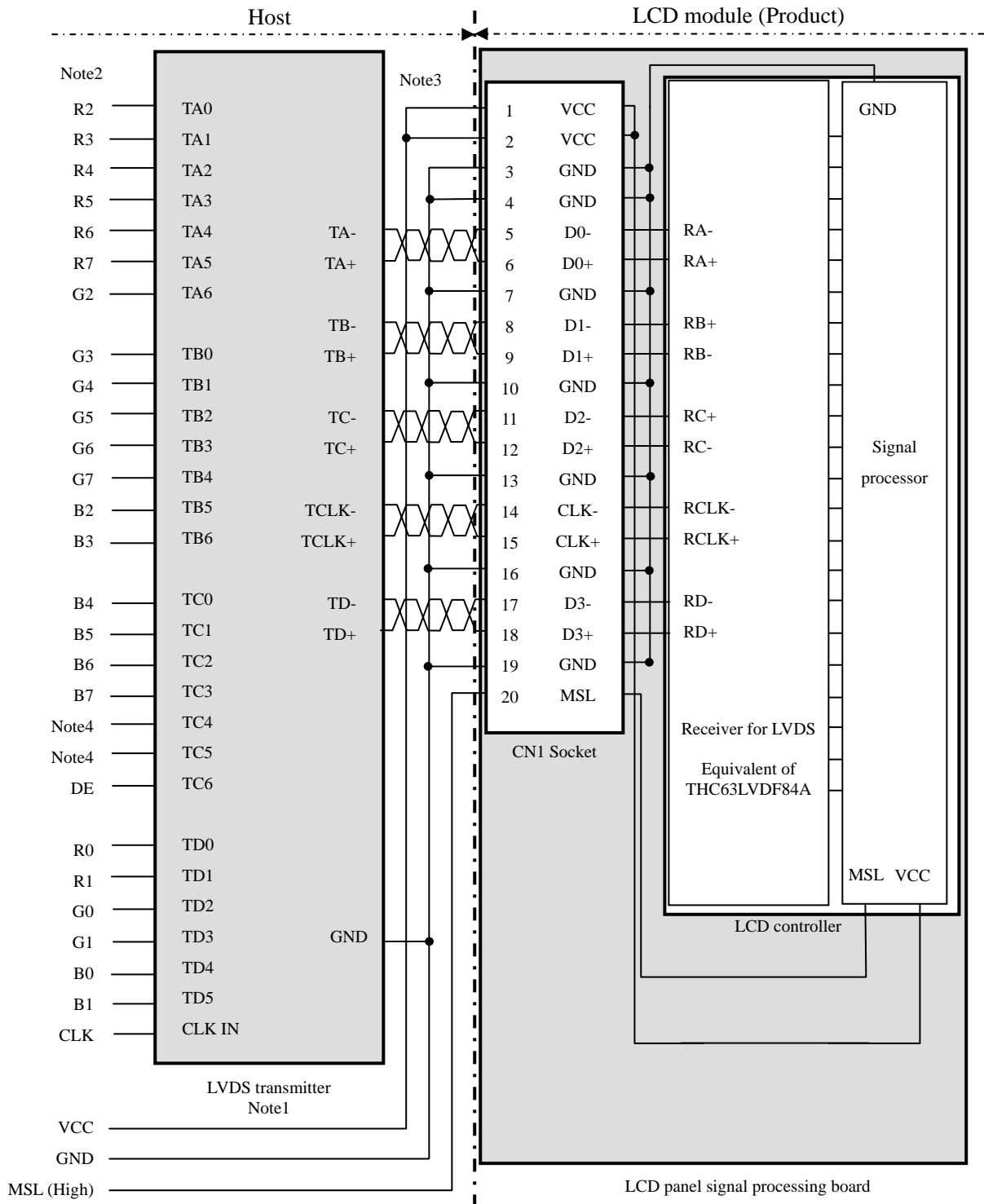

Note1: Recommended transmitter: THC63LVDF83A, THC63LVDM83R (Thine Electronics Inc.) or equivalent

Note2: LSB (Least Significant Bit) – R0, G0, B0 MSB (Most Significant Bit) – R7, G7, B7

Note3: Twist pair wires with 100Ω (Characteristic impedance) should be connected between LCD panel signal processing board and LVDS transmitter.

Note4: Input signals to TC4 and TC5 are not used inside the product, but do not keep TC4 and TC5 open to avoid noise problem.

PRELIMINARY

(2) Input LVDS map B (MSL: "Low" or "Open")

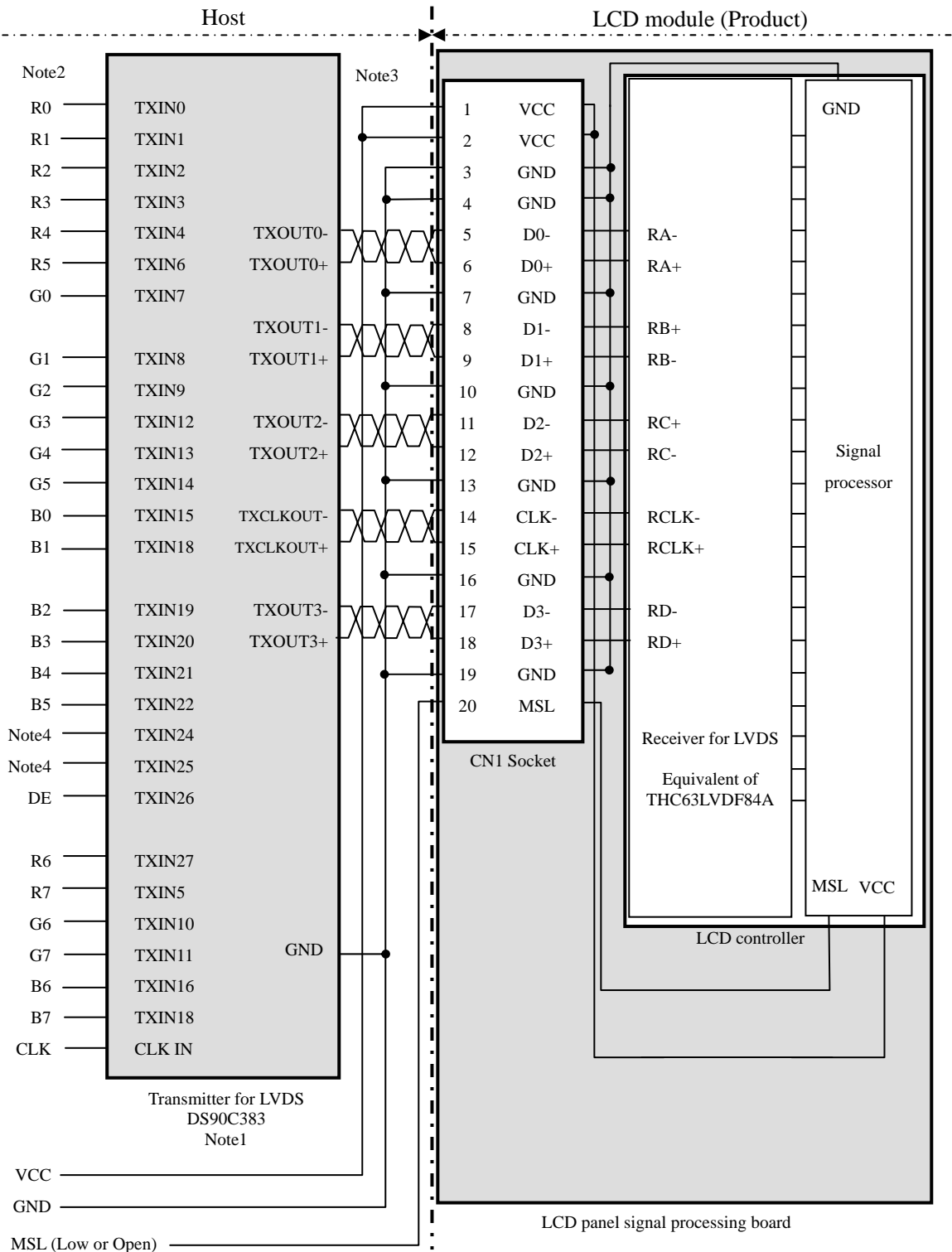

Note1: Recommended transmitter: DS90C383 (National Semiconductor) or equivalent

Note2: LSB (Least Significant Bit) – R0, G0, B0 MSB (Most Significant Bit) – R7, G7, B7

Note3: Twist pair wires with 100Ω (Characteristic impedance) should be connected between LCD panel signal processing board and LVDS transmitter.

Note4: Input signals to TC4 and TC5 are not used inside the product, but do not keep TC4 and TC5 open to avoid noise problem.

PRELIMINARY

4.6 DISPLAY COLORS AND INPUT DATA SIGNALS

This product can display in equivalent to 16,777,216 colors in 256 gray scales. Also the relation between display colors and input data signals is as the following table.

Display colors		Data signal (0: Low level, 1: High level)																							
		R7	R6	R5	R4	R3	R2	R1	R0	G7	G6	G5	G4	G3	G2	G1	G0	B7	B6	B5	B4	B3	B2	B1	B0
Basic Colors	Black	0	0	0	0	0	0	0	0	0	0	0	0	0	0	0	0	0	0	0	0	0	0	0	0
	Blue	0	0	0	0	0	0	0	0	0	0	0	0	0	0	0	0	1	1	1	1	1	1	1	1
	Red	1	1	1	1	1	1	1	1	0	0	0	0	0	0	0	0	0	0	0	0	0	0	0	0
	Magenta	1	1	1	1	1	1	1	1	0	0	0	0	0	0	0	0	1	1	1	1	1	1	1	1
	a	0	0	0	0	0	0	0	0	1	1	1	1	1	1	1	1	0	0	0	0	0	0	0	0
	Green	0	0	0	0	0	0	0	0	1	1	1	1	1	1	1	1	1	1	1	1	1	1	1	1
	Cyan	1	1	1	1	1	1	1	1	1	1	1	1	1	1	1	1	0	0	0	0	0	0	0	0
	Yellow	1	1	1	1	1	1	1	1	1	1	1	1	1	1	1	1	1	1	1	1	1	1	1	1
	White	1	1	1	1	1	1	1	1	1	1	1	1	1	1	1	1	1	1	1	1	1	1	1	1
Red gray scale	Black	0	0	0	0	0	0	0	0	0	0	0	0	0	0	0	0	0	0	0	0	0	0	0	0
		0	0	0	0	0	0	0	1	0	0	0	0	0	0	0	0	0	0	0	0	0	0	0	0
	dark	0	0	0	0	0	0	1	0	0	0	0	0	0	0	0	0	0	0	0	0	0	0	0	0
	↑					⋮																			
	↓					⋮																			
bright	1	1	1	1	1	1	0	1	0	0	0	0	0	0	0	0	0	0	0	0	0	0	0	0	
	1	1	1	1	1	1	1	0	0	0	0	0	0	0	0	0	0	0	0	0	0	0	0	0	
Red	1	1	1	1	1	1	1	1	0	0	0	0	0	0	0	0	0	0	0	0	0	0	0	0	
Green gray scale	Black	0	0	0	0	0	0	0	0	0	0	0	0	0	0	0	0	0	0	0	0	0	0	0	0
		0	0	0	0	0	0	0	0	0	0	0	0	0	0	0	1	0	0	0	0	0	0	0	0
	dark	0	0	0	0	0	0	0	0	0	0	0	0	0	0	1	0	0	0	0	0	0	0	0	0
	↑					⋮																			
	↓					⋮																			
bright	0	0	0	0	0	0	0	0	1	1	1	1	1	1	0	1	0	0	0	0	0	0	0	0	
	0	0	0	0	0	0	0	0	1	1	1	1	1	1	1	0	0	0	0	0	0	0	0	0	
Green	0	0	0	0	0	0	0	0	1	1	1	1	1	1	1	1	0	0	0	0	0	0	0	0	
Blue gray scale	Black	0	0	0	0	0	0	0	0	0	0	0	0	0	0	0	0	0	0	0	0	0	0	0	0
		0	0	0	0	0	0	0	0	0	0	0	0	0	0	0	0	0	0	0	0	0	0	0	1
	dark	0	0	0	0	0	0	0	0	0	0	0	0	0	0	0	0	0	0	0	0	0	0	1	0
	↑					⋮																			
	↓					⋮																			
bright	0	0	0	0	0	0	0	0	0	0	0	0	0	0	0	0	1	1	1	1	1	1	0	1	
	0	0	0	0	0	0	0	0	0	0	0	0	0	0	0	0	1	1	1	1	1	1	1	0	
Blue	0	0	0	0	0	0	0	0	0	0	0	0	0	0	0	0	1	1	1	1	1	1	1	1	

4.7 DISPLAY POSITIONS

The following table is the coordinates per pixel (See "4.8 SCANNING DIRECTIONS").

$C(1, 1)$

R	G	B
---	---	---

$C(1, 1)$	$C(2, 1)$...	$C(X, 1)$...	$C(1023, 1)$	$C(1024, 1)$
$C(1, 2)$	$C(2, 2)$...	$C(X, 2)$...	$C(1023, 2)$	$C(1024, 2)$
•	•	•	•	•	•	•
•	•	•••	•	•••	•	•••
•	•	•	•	•	•	•
$C(1, Y)$	$C(2, Y)$...	$C(X, Y)$...	$C(1023, Y)$	$C(1024, Y)$
•	•	•	•	•	•	•
•	•	•••	•	•••	•	•
•	•	•	•	•	•	•
$C(1, 767)$	$C(2, 767)$...	$C(X, 767)$...	$C(1023, 767)$	$C(1024, 767)$
$C(1, 768)$	$C(2, 768)$...	$C(X, 768)$...	$C(1023, 768)$	$C(1024, 768)$

4.8 SCANNING DIRECTIONS

The following figures are seen from a front view. Also the arrow shows the direction of scan.

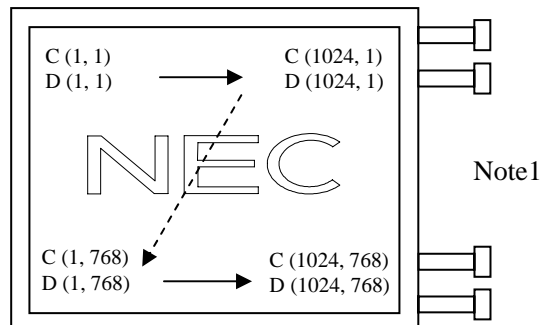

Note1: Meaning of C (X, Y) and D (X, Y)

C (X, Y): The coordinates of the display position (See "4.7 DISPLAY POSITIONS".)

D (X, Y): The data number of input signal for LCD panel signal processing board

4.9 INPUT SIGNAL TIMINGS

4.9.1 Outline of input signal timings

- Horizontal signal
Note1

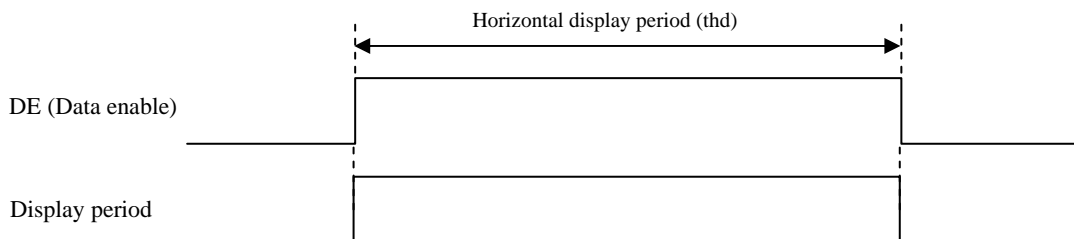

- Vertical signal
Note1

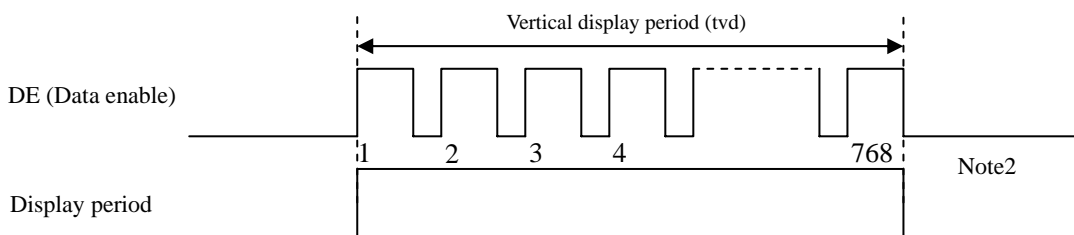

Note1: This diagram indicates virtual signal for set up to timing.

Note2: See "**4.9.3 Input signal timing chart**" for numeration of pulse.

PRELIMINARY

4.9.2 Timing characteristics

(Note1)

Parameter		Symbol	min.	typ.	max.	Unit	Remarks	
CLK	Frequency	1/tc	TBD	(65.0)	TBD	MHz	15.384 ns (typ.)	
	Duty	-	-			-	Note2	
	Rise time, Fall time	-				ns		
DATA	CLK-DATA	Setup time	-	-			ns	Note2
		Hold time	-				ns	
	Rise time, Fall time	-	ns					
DE	Horizontal	Cycle	th	TBD	(20.676)	-	μs	48.363 kHz (typ.) Note3
				TBD	(1,344)	TBD	CLK	
	Vertical (One frame)	Cycle	tv	TBD	(16.666)	TBD	ms	60.0 Hz (typ.)
				TBD	(806)	-	H	
	CLK-DE	Setup time	-	-			ns	Note2
							ns	
	Rise time, Fall time		-	-			ns	

Note1: Definition of parameters is as follows.

$$tc = 1CLK, th = 1H$$

Note2: See the data sheet of LVDS transmitter.

Note3: "th" must keep the fluctuation within ± 1 CLK, because of avoidance of image sticking.

4.9.3 Input signal timing chart

Horizontal timing

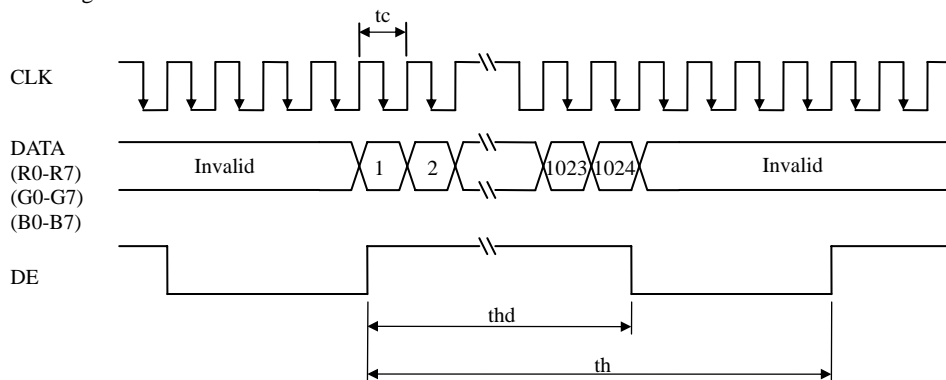

Vertical timing

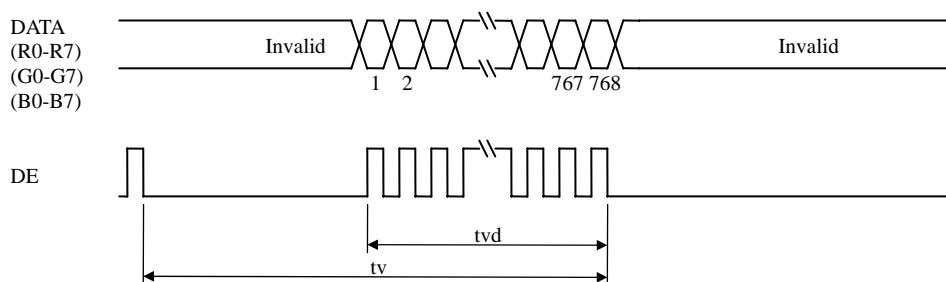

4.10 OPTICS

4.10.1 Optical characteristics

(Note1, Note2)

Parameter	Condition	Symbol	min.	typ.	max.	Unit	Measuring instrument	Remarks	
Luminance	White at center $\theta R = 0^\circ, \theta L = 0^\circ, \theta U = 0^\circ, \theta D = 0^\circ$	L	TBD	(300)	-	cd/m ²	BM5A or SR-3	-	
Contrast ratio	White/Black at center $\theta R = 0^\circ, \theta L = 0^\circ, \theta U = 0^\circ, \theta D = 0^\circ$	CR	TBD	(450)	-	-	BM5A or SR-3	Note3	
Luminance uniformity	White $\theta R = 0^\circ, \theta L = 0^\circ, \theta U = 0^\circ, \theta D = 0^\circ$	LU	-	(1.1)	1.3	-	BM-5A	Note4	
Chromaticity	White	x coordinate	W _x	TBD	0.313	TBD	-	SR-3	Note5
		y coordinate	W _y	TBD	0.329	TBD	-		
	Red	x coordinate	R _x	-	TBD	-	-		
		y coordinate	R _y	-	TBD	-	-		
	Green	x coordinate	G _x	-	TBD	-	-		
		y coordinate	G _y	-	TBD	-	-		
Blue	x coordinate	B _x	-	TBD	-	-			
	y coordinate	B _y	-	TBD	-	-			
Color gamut	$\theta R = 0^\circ, \theta L = 0^\circ, \theta U = 0^\circ, \theta D = 0^\circ$ at center, against NTSC color space	C	TBD	72	-	%			
Response time	Black to white	T _{on}	-	TBD	TBD	ms	BM-5A	Note6 Note7	
	White to black	T _{off}	-	TBD	TBD	ms			
	T _{on} +T _{off}		-	(25)	-	ms			
Viewing angle	Right	$\theta U = 0^\circ, \theta D = 0^\circ, CR \geq 10$	θR	TBD	85	-	BM-5A	Note8	
	Left	$\theta U = 0^\circ, \theta D = 0^\circ, CR \geq 10$	θL	TBD	85	-			
	Up	$\theta R = 0^\circ, \theta L = 0^\circ, CR \geq 10$	θU	TBD	85	-			
	Down	$\theta R = 0^\circ, \theta L = 0^\circ, CR \geq 10$	θD	TBD	85	-			

Note1: These are initial characteristics.

Note2: Measurement conditions are as follows.

T_a = 25°C, VCC = 3.3V, IBL = (6.0)mArms/lamp, Display mode: XGA,
Horizontal cycle = 48.363kHz, Vertical cycle = 60.0Hz

Optical characteristics are measured at luminance saturation after 20minutes from working the product, in the dark room. Also measurement method for luminance is as follows.

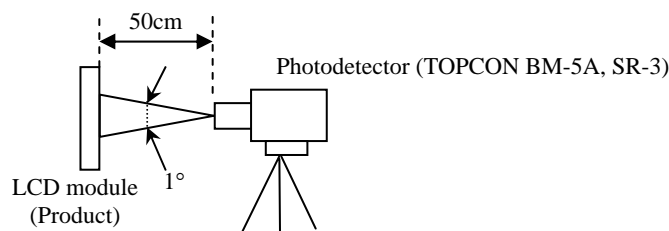

Note3: See "4.10.2 Definition of contrast ratio".

Note4: See "4.10.3 Definition of luminance uniformity".

Note5: These coordinates are found on CIE 1931 chromaticity diagram.

Note6: Product surface temperature: TopF = TBD°C

Note7: See "4.10.4 Definition of response times".

Note8: See "4.10.5 Definition of viewing angles".

4.10.2 Definition of contrast ratio

The contrast ratio is calculated by using the following formula.

$$\text{Contrast ratio (CR)} = \frac{\text{Luminance of white screen}}{\text{Luminance of black screen}}$$

4.10.3 Definition of luminance uniformity

The luminance uniformity is calculated by using following formula.

$$\text{Luminance uniformity (LU)} = \frac{\text{Maximum luminance from ① to ⑤}}{\text{Minimum luminance from ① to ⑤}}$$

The luminance is measured at near the 5 points shown below.

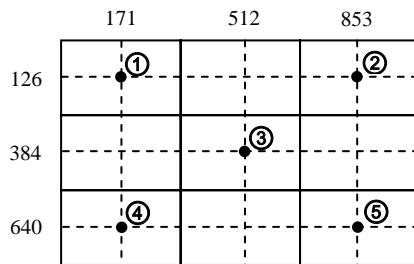

4.10.4 Definition of response times

Response time is measured, the luminance changes from "white" to "black", or "black" to "white" on the same screen point, by photo-detector. Ton is the time it takes the luminance change from 90% down to 10%. Also Toff is the time it takes the luminance change from 10% up to 90% (See the following diagram.).

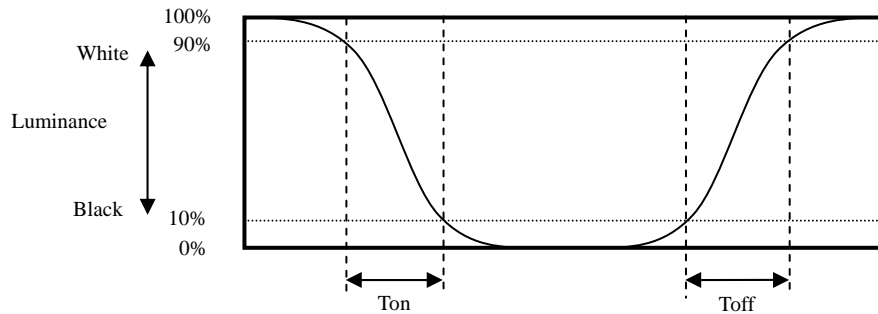

4.10.5 Definition of viewing angles

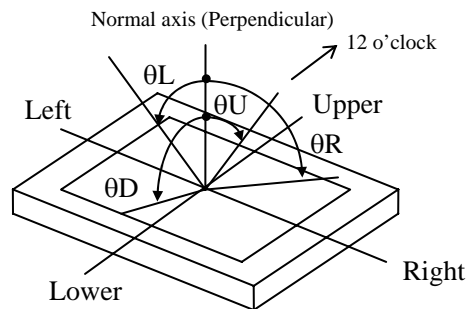

5. RELIABILITY TESTS

Test item		Condition	Judgement	Note1
High temperature and humidity (Operation)		TBD	No display malfunctions	
Heat cycle (Operation)				
Thermal shock (Non operation)				
ESD (Operation)				
Dust (Operation)			No display malfunctions No physical damages	
Vibration (Non operation)				
Mechanical shock (Non operation)				
Low pressure	operation		No display malfunctions	
	non-operation			

Note1: Display and appearance are checked under environmental conditions equivalent to the inspection conditions of defect criteria.

Note2: See the following figure for discharge points.

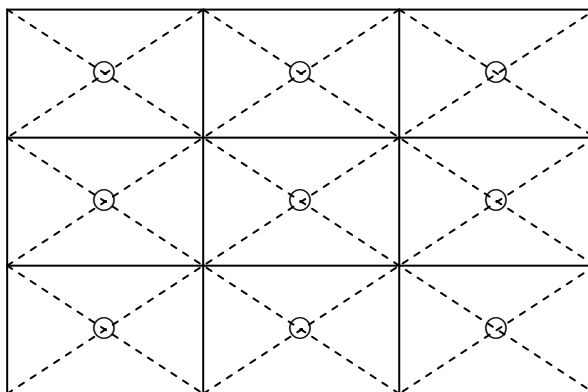

6. PRECAUTIONS

6.1 MEANING OF CAUTION SIGNS

The following caution signs have very important meaning. **Be sure to read "6.2 CAUTIONS" and "6.3 ATTENTIONS", after understanding these contents!**



This sign has the meaning that customer will be injured by himself or the product will sustain a damage, if customer has wrong operations.



This sign has the meaning that customer will get an electrical shock, if customer has wrong operations.



This sign has the meaning that customer will be injured by himself, if customer has wrong operations.

6.2 CAUTIONS



*** Do not touch the working backlight. Customer will be in danger of an electric shock.**



*** Do not touch the working backlight. Customer will be in danger of burn injury.
* Do not shock and press the LCD panel and the backlight! There is a danger of breaking, because they are made of glass. (Shock: To be not greater TBD m/s² and to be not greater TBD ms, Pressure: To be not greater TBD N)**

6.3 ATTENTIONS



6.3.1 Handling of the product

- ① Take hold of both ends without touch the circuit board cover when customer pulls out products (LCD modules) from inner packing box. If customer touches it, products may be broken down or out of adjustment, because of stress to mounting parts.
- ② Do not hook cables nor pull connection cables such as lamp cable and so on, for fear of damage.
- ③ If customer puts down the product temporarily, the product puts on flat subsoil as a display side turns down.
- ④ Take the measures of electrostatic discharge such as earth band, ionic shower and so on, when customer deals with the product, because products may be damaged by electrostatic.
- ⑤ The torque for mounting screws must never exceed TBD N-m. Higher torque values might result in distortion of the bezel.
- ⑥ The product must be installed using mounting holes without undue stress such as bends or twist (See outline drawings). And do not add undue stress to any portion (such as bezel flat area) except mounting hole portion.
Bends or twist described above and undue stress to any portion except mounting hole portion may cause display un-uniformity.
- ⑦ Do not press or rub on the sensitive display surface. If customer clean on the panel surface, NEC recommends using the cloth with ethanolic liquid such as screen cleaner for LCD.

- ⑧ Do not push-pull the interface connectors while the product is working, because wrong power sequence may break down the product.
- ⑨ Do not bend or unbend the lamp cable at the near part of the lamp holding rubber, to avoid the damage for high voltage side of the lamp. This damage may cause a lamp breaking and abnormal operation of high voltage circuit.
- ⑩ When installing the lamp cable, do not attach the lamp cable on the metal part of the LCD module directly. This may cause leakage high frequency current to the metal part, then the brightness may decrease or the lamp may not light.
- ⑪ When not connecting FG of the LCD module to the customer's equipment ground, inverter noise may create a beat frequency that will cause video noise on the LCD screen.
- ⑫ When customer deals with the product, use of an original protection sheet on the product surface (polarizer) is recommended for protection of panel surface. Adhesive type protection sheet may change color or properties of the polarizer.

6.3.2 Environment

- ① Do not operate or store in high temperature, high humidity, dewdrop atmosphere or corrosive gases. Keep the product in antistatic pouch in room temperature, because of avoidance for dusts and sunlight, if customer stores the product.
- ② In order to prevent dew condensation occurring by temperature difference, the product packing box must be opened after leave under the environment of an unpacking room temperature enough. Because a situation of dew condensation occurring is changed by the environmental temperature and humidity, evaluate the leaving time sufficiently. (Recommendation leaving time: 6 hour or more with packing state)
- ③ Do not operate in high magnetic field. Circuit boards may be broken down by it.
- ④ This product is not designed as radiation hardened.

6.3.3 Characteristics

The following items are neither defects nor failures.

- ① Response time, luminance and color may be changed by ambient temperature.
- ② The LCD may be seemed luminance non-uniformity, flicker, vertical seam or small spot by display patterns.
- ③ Optical characteristics (e.g. luminance, display uniformity, etc.) gradually is going to change depending on operating time, and especially low temperature, because the LCD has cold cathode fluorescent lamps.
- ④ Do not display the fixed pattern for a long time because it may cause image sticking. Use a screen saver, if the fixed pattern is displayed on the screen.
- ⑤ The display color may be changed by viewing angle because of the use of condenser sheet in the backlight.
- ⑥ Optical characteristics may be changed by input signal timings.
- ⑦ The interference noise of input signal frequency for this product's signal processing board and luminance control frequency of customer's backlight inverter may appear on a display. Set up luminance control frequency of backlight inverter so that the interference noise does not appear.

6.3.4 Other

- ① All GND and VCC terminals should be used without any non-connected lines.
- ② Do not disassemble a product or adjust variable resistors without permission of NEC.
- ③ See "REPLACEMENT MANUAL FOR LAMP HOLDER SET", if customer would like to replace backlight lamps.
- ④ Pay attention not to insert waste materials inside of products, if customer uses screwdrivers.
- ⑤ Pack the product with original shipping package, because of avoidance of some damages during transportation, when customer returns it to NEC for repair and so on.
- ⑥ The LCD module by itself or integrated into end product should be packed and transported with display in the vertically position. Otherwise the display characteristics may be impaired.

7. OUTLINE DRAWINGS

7.1 FRONT VIEW

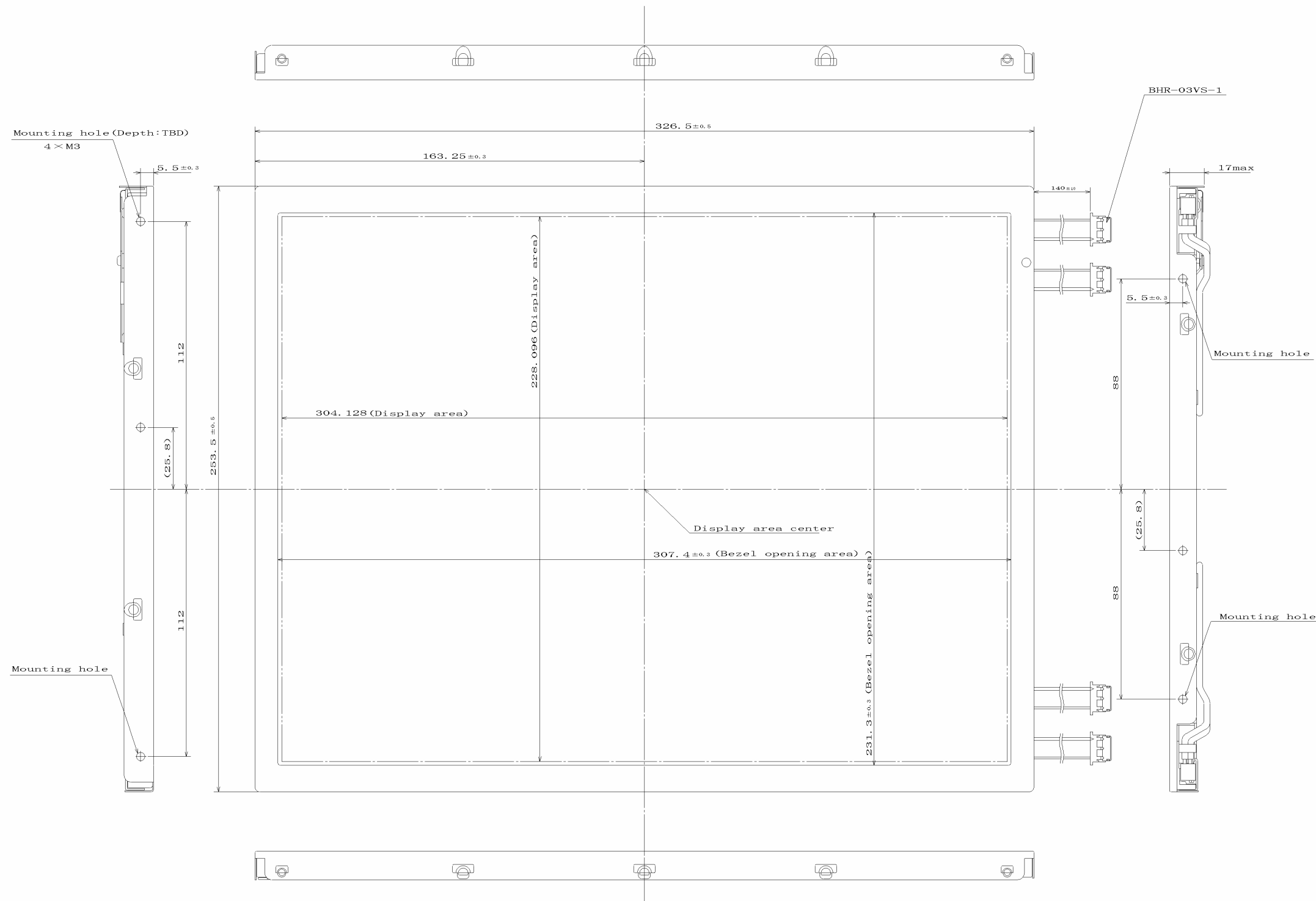

Note1: The values in parentheses are for reference.
Note2: Not shown tolerances of the dimensions are TBD mm.
Note3: The torque for mounting screws must never exceed TBD N·m.

Unit: mm

PRELIMINARY

7.2 REAR VIEW

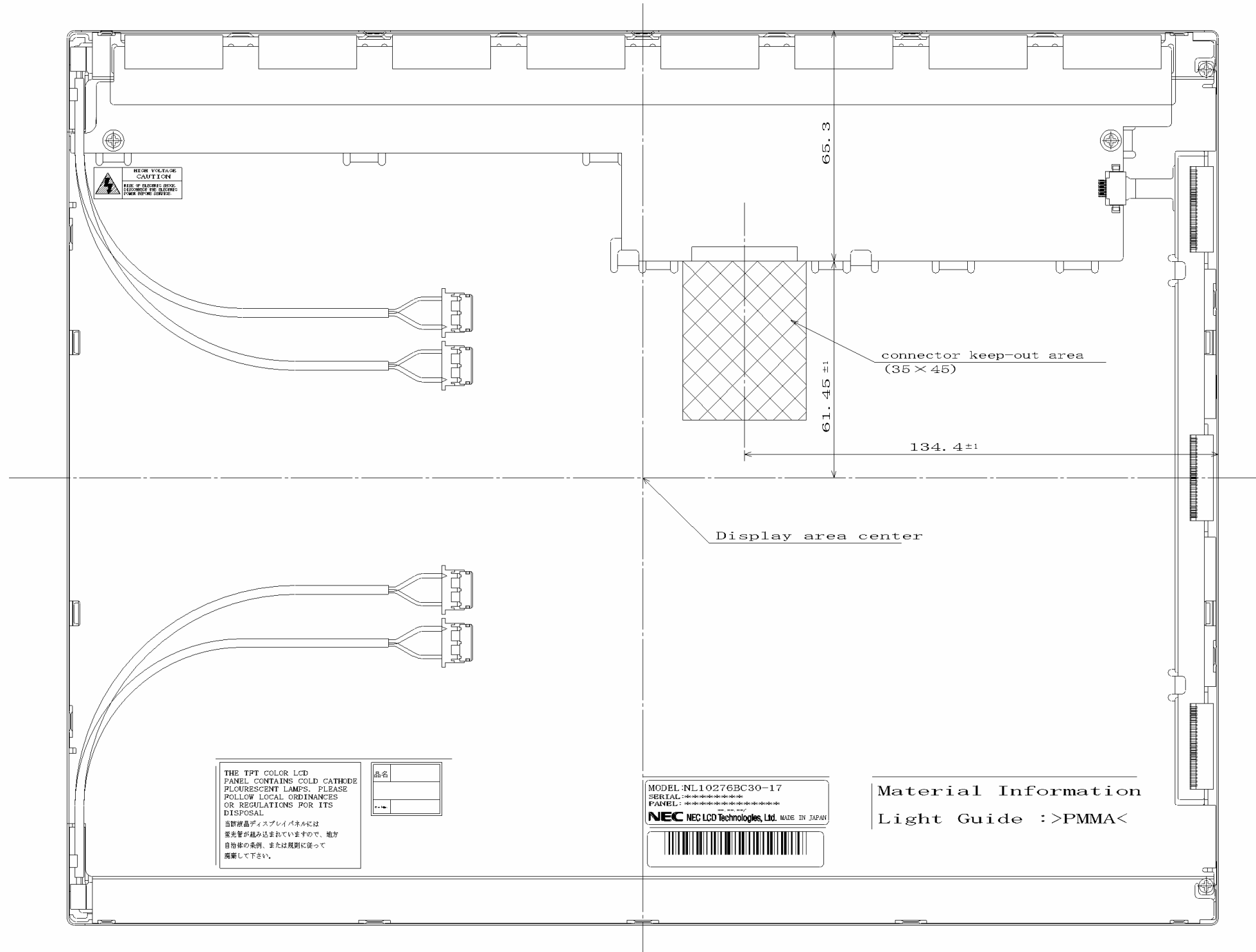







- Note1: The values in parentheses are for reference.
- Note2: Not shown tolerances of the dimensions are TBD mm.
- Note3: The torque for mounting screws must never exceed TBD N·m.

Unit: mm

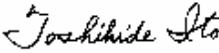
PRELIMINARY

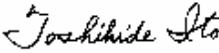
REVISION HISTORY

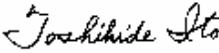
The inside of latest specifications is revised to the clerical error and the major improvement of previous edition. Only a changed part such as functions, characteristic value and so on that may affect a design of customers, are described especially below.

Edition	Document number	Prepared date	Revision contents and signature									
1st edition	DOD-PD-0568	July 6, 2004	<p data-bbox="528 557 742 584">Revision contents</p> <p data-bbox="528 616 630 642">New issue</p> <p data-bbox="549 698 746 725">Signature of writer</p> <table data-bbox="592 725 1433 869"><tr><td data-bbox="592 725 703 752"><i>Approved by</i></td><td data-bbox="884 734 983 761"><i>Checked by</i></td><td data-bbox="1142 734 1262 761"><i>Prepared by</i></td></tr><tr><td data-bbox="627 757 847 808"></td><td data-bbox="900 824 1050 828">_____</td><td data-bbox="1177 790 1417 817"></td></tr><tr><td data-bbox="699 831 767 857">T. ITO</td><td data-bbox="900 853 1129 857">_____</td><td data-bbox="1198 835 1378 862">R. KAWASHIMA</td></tr></table>	<i>Approved by</i>	<i>Checked by</i>	<i>Prepared by</i>		_____		T. ITO	_____	R. KAWASHIMA
<i>Approved by</i>	<i>Checked by</i>	<i>Prepared by</i>										
	_____											
T. ITO	_____	R. KAWASHIMA										