

for RF/Local

Chip Multilayer LC Filters (BPF)

● LFB18/21/2H/31_SG Series

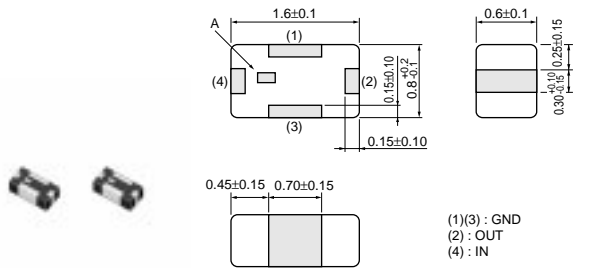

LFB18_SG Series

A : Directional Input Mark
All the technical data and information contained herein are subject to change without prior notice. (in mm)

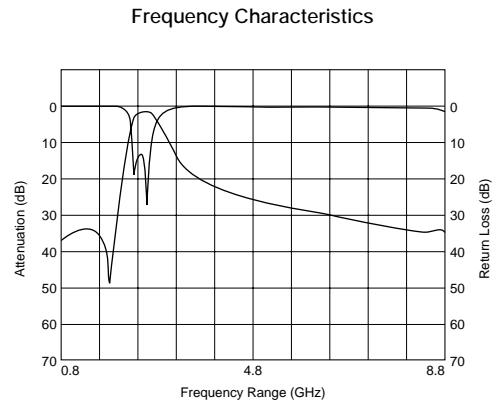

LFB21_SG Series

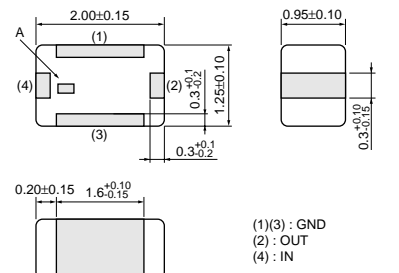

A : Directional Input Mark
All the technical data and information contained herein are subject to change without prior notice. (in mm)

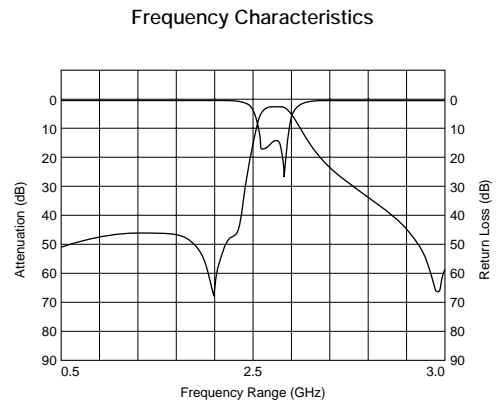

LFB2H_SG6 Series

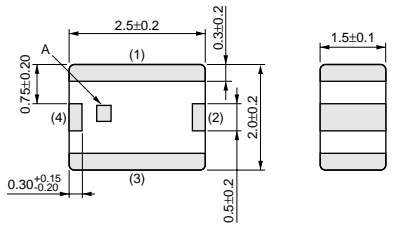

A : Directional Input Mark
All the technical data and information contained herein are subject to change without prior notice. (in mm)

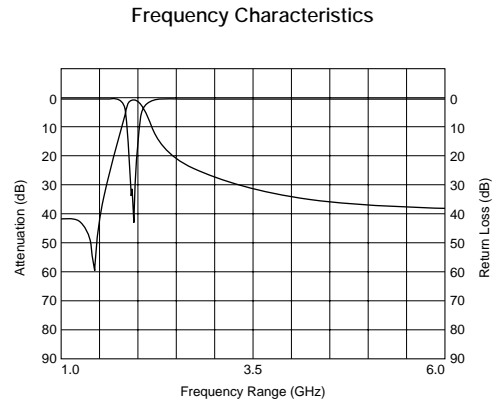

LFB2H_SG7 Series

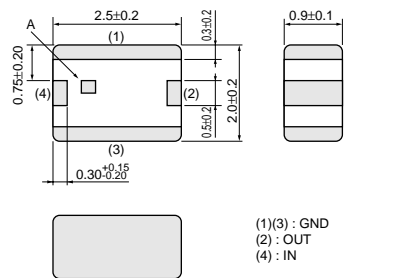

A : Directional Input Mark
All the technical data and information contained herein are subject to change without prior notice. (in mm)

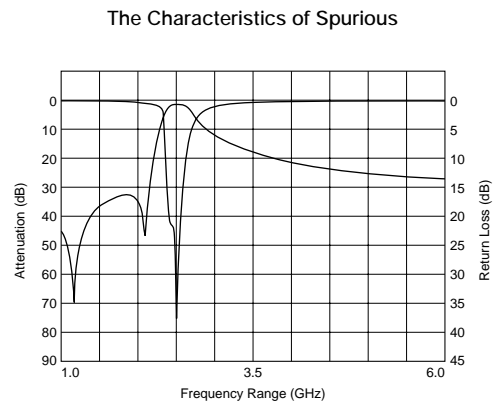

Continued on the following page.

Continued from the preceding page.



LFB31_SG1 Series

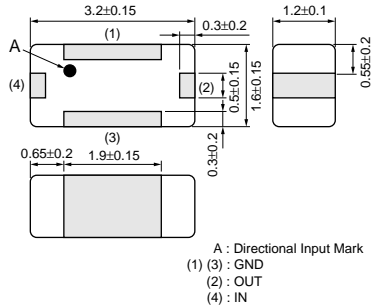

All the technical data and information contained herein are subject to change without prior notice. (in mm)

Frequency Characteristics

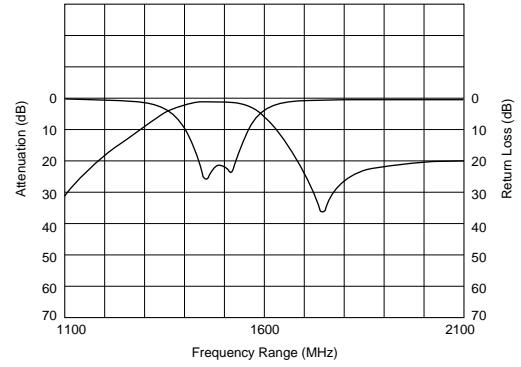

LFB31_SG2 Series

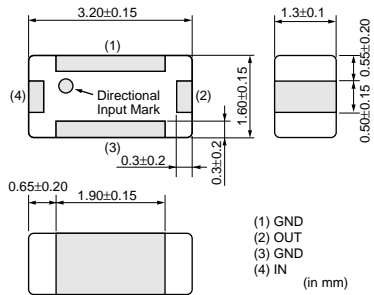

All the technical data and information contained herein are subject to change without prior notice.

Frequency Characteristics

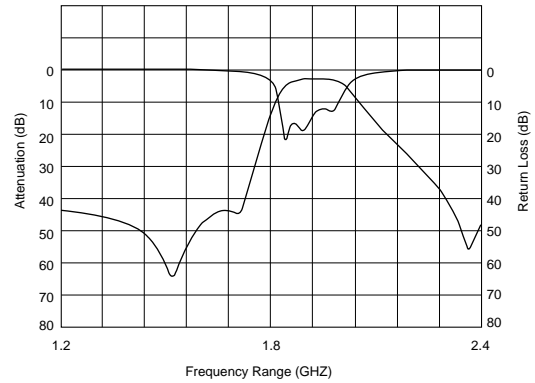

LFB31_SG3 Series

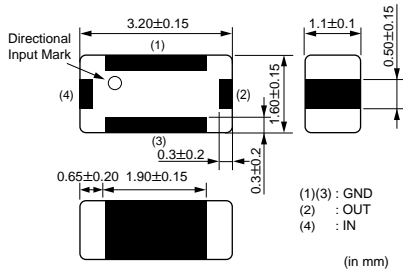

All the technical and information contained herein are subject to change without prior notice.

Frequency Characteristics

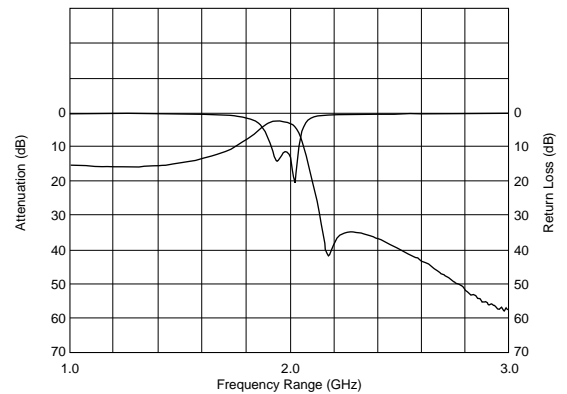

LFB31_SG7 Series

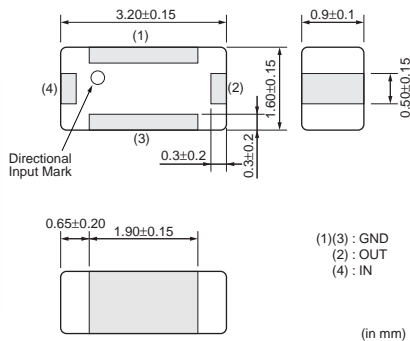

All the technical data and information contained herein are subject to change without prior notice.

Frequency Characteristics

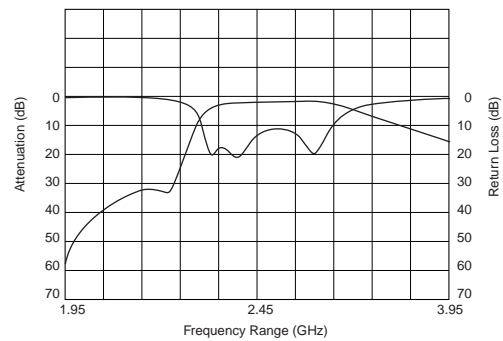

Note • This PDF catalog is downloaded from the website of Murata Manufacturing Co., Ltd. Therefore, its specifications are subject to change or our products in it may be discontinued without advance notice. Please check with our sales representatives or product engineers before ordering.
 • This PDF catalog has only typical specifications because there is no space for detailed specifications. Therefore, please approve our product specifications or transact the approval sheet for product specifications before ordering.

Part Number	Nominal Center Frequency (fo) (MHz)	Bandwidth (BW) (MHz)	Insertion Loss in BW (dB)	Attenuation (Absolute Value) I) (dB)	Attenuation (Absolute Value) II) (dB)
LFB182G45SG9A246	2450	fo±50	2.2 max. (at 25°C)	24.5 min. at 880~960MHz	12.5 min. at 1710~1990MHz
LFB185G78SGAB713	5787.5	fo±62.5	2.2 max. (at 25°C)	16.5 min. at 4800MHz	23.5 min. at 11450~11700MHz
LFB211G90SG8B704	1906.5	fo±13.5	3.0 max. (at 25°C)	20 min. at 1660.5~1686.3MHz	11 min. at 2126.8~2152.6MHz
LFB212G45SG8A127	2450	fo±50	1.5 max. (at 25°C)	25 min. at 1200~1300MHz	10.0 min. at 2000MHz
LFB212G45SG8A166	2450	fo±50	1.4 max. (at 25°C)	30 min. at 880~915MHz	30 min. at 1710~1910MHz
LFB212G45SG8A192	2450	fo±50	2.6 max. (at 25°C)	40 min. at 880~960MHz	38 min. at 1710~1990MHz
LFB215G12SG8A178	5125	fo±225	1.5 max. (at 25°C)	25 min. at 4200MHz	17 min. at 2x(fo±225)MHz
LFB215G12SG8A183	5125	fo±225	1.5 max. (at 25°C)	10.0 min. at 4250MHz	10.0 min. at 5900MHz
LFB215G25SG8A144	5250	fo±100.0	1.5 max. (at 25°C)	30 min. at 3450MHz	-
LFB215G37SG8A180	5375	fo±475	1.8 max. (at 25°C)	29.5 min. at 500~4000MHz	34.5 min. at 3450MHz
LFB215G37SG8A185	5375	fo±475	2.2 max. (at 25°C)	40 min. at 340~1195MHz	21 min. at 2140~3580MHz
LFB215G51SG8A132	5512	fo±363	1.9 max. (at 25°C)	30 min. at 500~4000MHz	20 min. at 4600MHz
LFB215G51SG8A154	5512	fo±363	1.5 max. (at 25°C)	30 min. at 500~4000MHz	20 min. at 4600MHz
LFB215G78SG8A170	5787.5	fo±62.5	2.2 max. (at 25°C)	35 min. at 3275~3400MHz	37 min. at 2x(fo±62.5)MHz
LFB2H1G90SG6A157	1906.5	fo±13.5	1.5 max. (at 25°C)	14 min. at 1687MHz	6 min. at 2126MHz
LFB2H2G45SG7A134	2450	fo±50	1.7 max. (at 25°C)	25 min. at 1750MHz	25 min. at 2100MHz
LFB2H2G45SG7A135	2450	fo±50	2.7 max. (at 25°C)	40 min. at 880~915MHz	40 min. at 1710~1950MHz
LFB2H2G45SG7A158	2450	fo±50	1.2 max. (at 25°C)	30 min. at 880~915MHz	30 min. at 1710~1785MHz
LFB2H2G45SG7A159	2450	fo±50	2.1 max. (at 25°C)	45 min. at 880~915MHz	48 min. at 1710~1990MHz
LFB2H2G45SG7A204	2450	fo±50	3 max. (at 25°C)	45 min. at 880~915MHz	27 min. at 1710~1990MHz
LFB2H5G78SG7A175	5787.5	fo±62.5	2.5 max. (at 25°C)	51.5 min. at 902~928MHz	41 min. at 3919~4044MHz
LFB311G48SG1-985	1489	fo±12.0	1.5 max. (at 25°C)	25 min. at (fo±12.0)+260MHz	28 min. at 1749MHz
LFB311G90SG1-799	1906.5	fo +24.5/-13.5MHz	2.5 max. (at 25°C)	40 min. at 1397.05~1422.85MHz	35 min. at 1645.5~1671.3MHz
LFB311G90SG2-797	1906.5	fo±13.5	2.7 max. (at 25°C)	40 min. at 1427~1454MHz	35 min. at 1660~1687MHz
LFB311G95SG3A564	1950	fo±30	3.5 max. (at 25°C)	20 min. at 2110~2170MHz	25 min. at 2490~2550MHz
LFB312G45SG2A509	2450	fo±50	2 max. (at 25°C)	38 min. at 902~928MHz	15 min. at 2100~2200MHz
LFB312G45SG7A572	2450	fo±50	2.5 max. (at 25°C)	37 min. at 902~928MHz	20 min. at 2100~2200MHz

● LFB31_SL Series (1206)

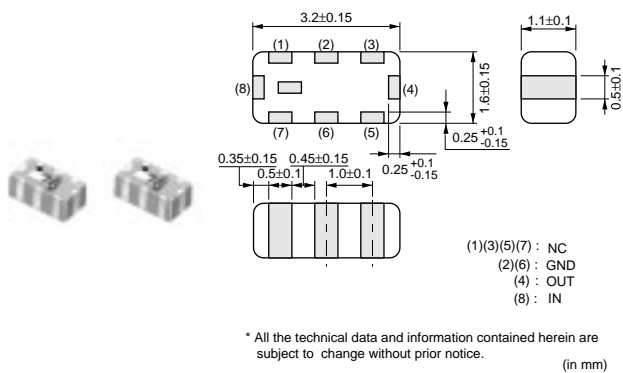

Frequency Characteristics

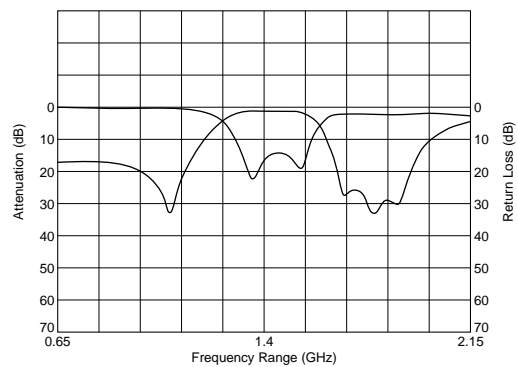

Part Number	Nominal Center Frequency (fo) (MHz)	Bandwidth (BW) (MHz)	Insertion Loss in BW (dB)	Attenuation (Absolute Value) I) (dB)	Attenuation (Absolute Value) II) (dB)
LFB311G40SL1A562	1402.5	fo±77.5	3 max. (at 25°C)	20 min. at 1005~1080MHz	20 min. at 1725~1760MHz

● LFB31_SN Series (1206)

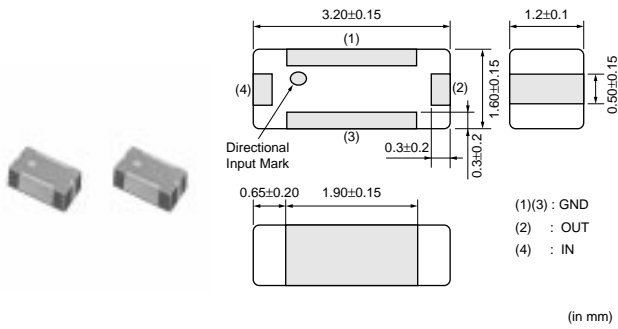

All the technical data and information contained herein are subject to change without prior notice.

Frequency Characteristics

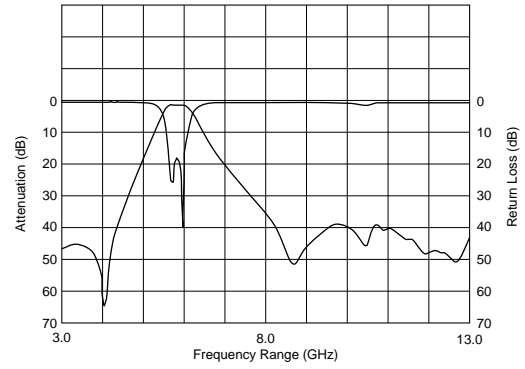

Part Number	Nominal Center Frequency (fo) (MHz)	Bandwidth (BW) (MHz)	Insertion Loss in BW (dB)	Attenuation (Absolute Value) I) (dB)	Attenuation (Absolute Value) II) (dB)
LFB315G82SN5-996	5820	fo±30	2 max. (at 25°C)	35 min. at 2000MHz	30 min. at 3000MHz

● LFB31_SP Series (1206)

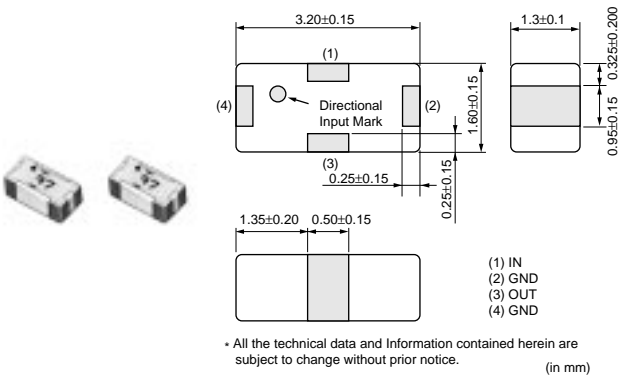

All the technical data and information contained herein are subject to change without prior notice.

Frequency Characteristics

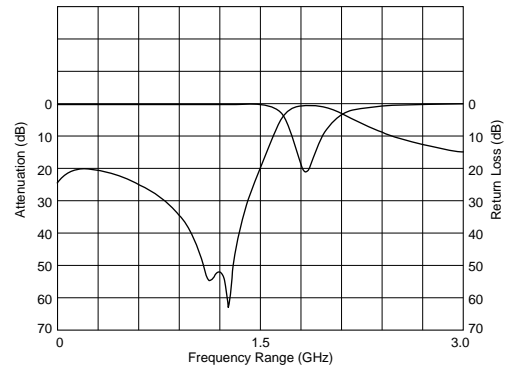

Part Number	Nominal Center Frequency (fo) (MHz)	Bandwidth (BW) (MHz)	Insertion Loss in BW (dB)	Attenuation (Absolute Value) I) (dB)	Attenuation (Absolute Value) II) (dB)
LFB311G89SP1A542	1890	fo±10.0	0.85 max. (at 25°C)	29 min. at 1416.9~1436.9Hz	22 min. at 900MHz
LFB311G90SP1-798	1906.5	fo±13.5	1.0 max. (at 25°C)	38 min. at 1405~1440MHz	12.0 min. at 1649~1680MHz
LFB312G45SP1A502	2450	fo±50	1.4 max. (at 25°C)	20 min. at 902~928MHz	35 min. at 1500~1550MHz

● LFB32_SB Series (1210)

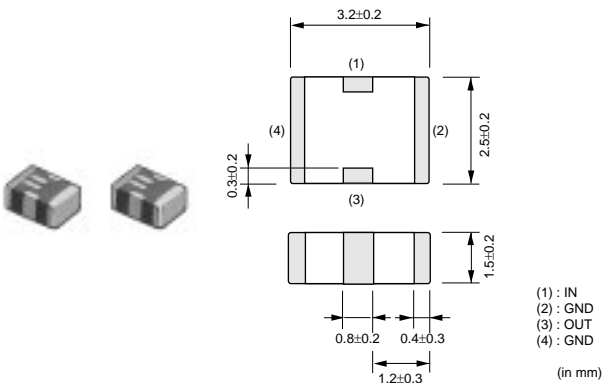

Frequency Characteristics

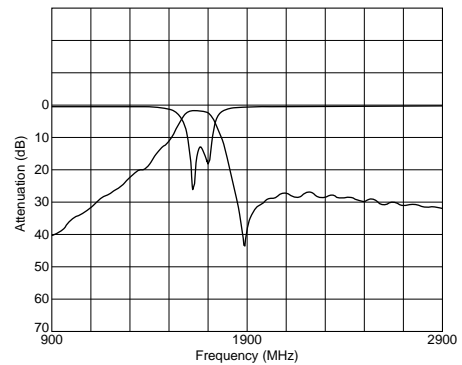

△Note • This PDF catalog is downloaded from the website of Murata Manufacturing Co., Ltd. Therefore, its specifications are subject to change or our products in it may be discontinued without advance notice. Please check with our sales representatives or product engineers before ordering.
• This PDF catalog has only typical specifications because there is no space for detailed specifications. Therefore, please approve our product specifications or transact the approval sheet for product specifications before ordering.

Part Number	Nominal Center Frequency (fo) (MHz)	Bandwidth (BW) (MHz)	Insertion Loss in BW (dB)	Attenuation (Absolute Value) I) (dB)	Attenuation (Absolute Value) II) (dB)
LFB321G66SB1-560	1662	fo±12.5	2 max. (at 25°C)	27 min. at 1895~1918MHz	20 min. at 2xfo MHz
LFB321G89SB1-591	1890	fo±10.0	1.2 max. (at 25°C)	21 min. at 1655~1675MHz	15 min. at 2xfo MHz
LFB321G90SB1-559	1907.5	fo±12.5	1.0 max. (at 25°C)	35 min. at 1397.5~1440MHz	20 min. at 1646~1680MHz

● LFB32_SC Series (1210)

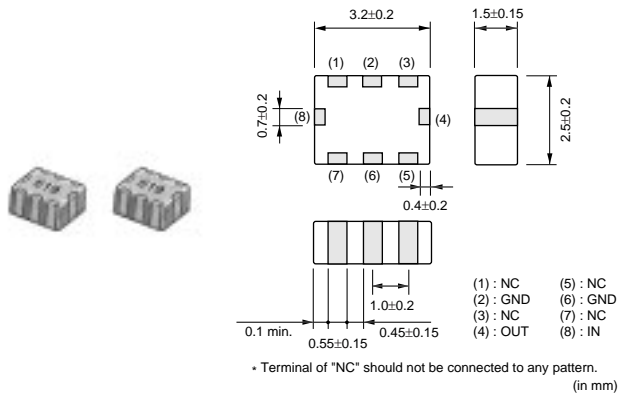

Frequency Characteristics

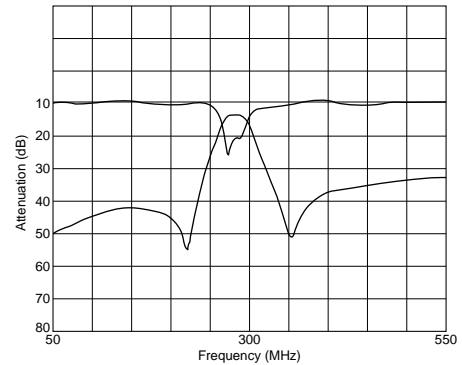

Part Number	Nominal Center Frequency (fo) (MHz)	Bandwidth (BW) (MHz)	Insertion Loss in BW (dB)	Attenuation (Absolute Value) I) (dB)	Attenuation (Absolute Value) II) (dB)
LFB32284MSC1-596	284	fo±4	3.8 max. (at 25°C)	31 min. at 220~228MHz	23 min. at 340~348MHz
LFB32312MSC1-597	312.25	fo±1.0	3.5 max. (at 25°C)	26 min. at 249.8MHz	26 min. at 374.7MHz
LFB32315MSC1-604	315	fo±0.5	3.5 max. (at 25°C)	45 min. at 180MHz	29 min. at 470MHz
LFB32315MSC1-619	315	fo±0	3.5 max. (at 25°C)	30 min. at 235MHz	30 min. at 395MHz
LFB32426MSC1-603	426.5	fo±0.5	3.6 max. (at 25°C)	25 min. at 366.5MHz	20 min. at 486.5MHz
LFB32820MSC2-749	820	fo±10.0	1.3 max. (at 25°C)	22 min. at 1070~1090MHz	-
LFB32847MSC2-766	847.5	fo±37.5	1.5 max. (at 25°C)	16 min. at 550~625MHz	15 min. at 1070~1145MHz

● LFB32_SJ Series (1210)

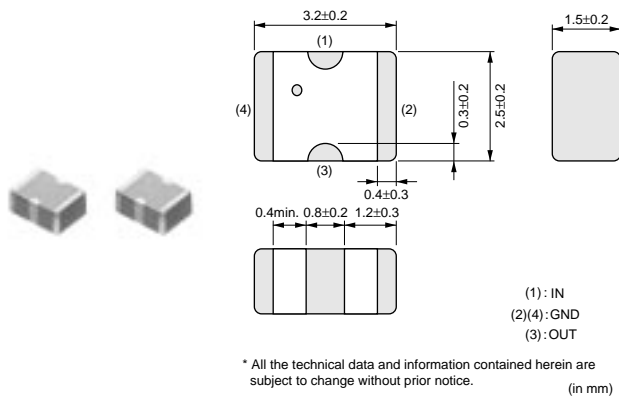

Frequency Characteristics

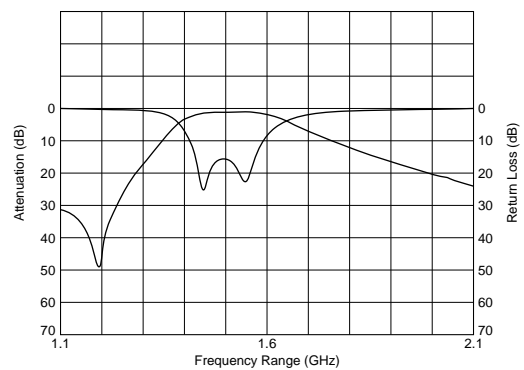

Part Number	Nominal Center Frequency (fo) (MHz)	Bandwidth (BW) (MHz)	Insertion Loss in BW (dB)	Attenuation (Absolute Value) I) (dB)	Attenuation (Absolute Value) II) (dB)
LFB321G47SJ1-794	1472	fo±20	1.3 max. (at 25°C)	30 min. at 1172MHz	-

● LFB32_SK Series (1210)

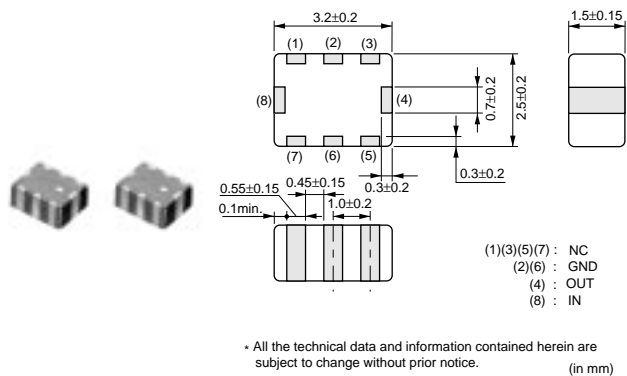

Frequency Characteristics

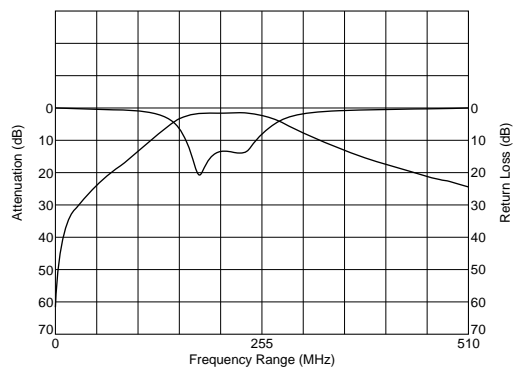

Part Number	Nominal Center Frequency (fo) (MHz)	Bandwidth (BW) (MHz)	Insertion Loss in BW (dB)	Attenuation (Absolute Value) I) (dB)	Attenuation (Absolute Value) II) (dB)
LFB32205MSK1-948	205.5	$f_o \pm 31.5$	1.5 max. (at 25°C)	10.0 min. at 100MHz	20 min. at 500MHz

● LFB32_SN Series (1210)

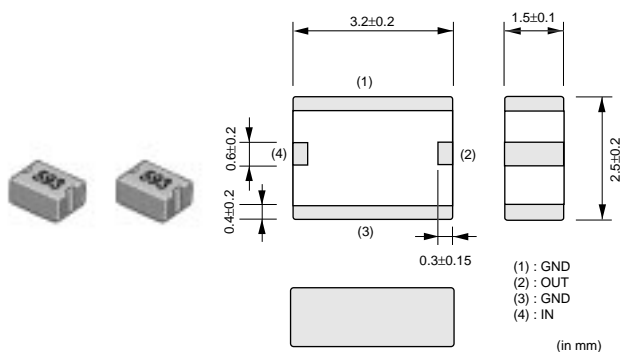

Frequency Characteristics

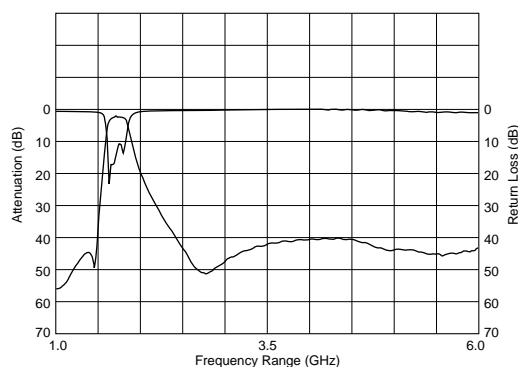

Part Number	Nominal Center Frequency (fo) (MHz)	Bandwidth (BW) (MHz)	Insertion Loss in BW (dB)	Attenuation (Absolute Value) I) (dB)	Attenuation (Absolute Value) II) (dB)
LFB321G74SN1-770	1747.5	$f_o \pm 37.5$	2.5 max. (at 25°C)	20 min. at D.C.~1350MHz	30 min. at 1350~1425MHz
LFB321G84SN1-796	1842.5	$f_o \pm 37.5$	2.5 max. (at 25°C)	48 min. at 500~1450MHz	40 min. at 1450~1480MHz
LFB321G90SN1-593	1907.5	$f_o \pm 12.5$	2.5 max. (at 25°C)	40 min. at 1406.5~1440MHz	35 min. at 1655~1680MHz
LFB322G45SN1-947	2450	$f_o \pm 50$	2.5 max. (at 25°C)	40 min. at 1950MHz	16 min. at 2200MHz
LFB322G45SN1A504	2450	$f_o \pm 50$	1.8 max. (at 25°C)	48 min. at 902~928MHz	50 min. at 1500~1550MHz
LFB322G45SN5A515	2450	$f_o \pm 50$	2.5 max. (at 25°C)	40 min. at 880~1250MHz	20 min. at 1250~1710MHz

△Note • This PDF catalog is downloaded from the website of Murata Manufacturing co., Ltd. Therefore, it's specifications are subject to change or our products in it may be discontinued without advance notice. Please check with our sales representatives or product engineers before ordering.
 • This PDF catalog has only typical specifications because there is no space for detailed specifications. Therefore, please approve our product specifications or transact the approval sheet for product specifications before ordering.

for RF/Local

Chip Multilayer LC Filters (LPF)

● LFL15_TC (0402) /LFL18_TC (0603) /LFL21_TC (0805) Series

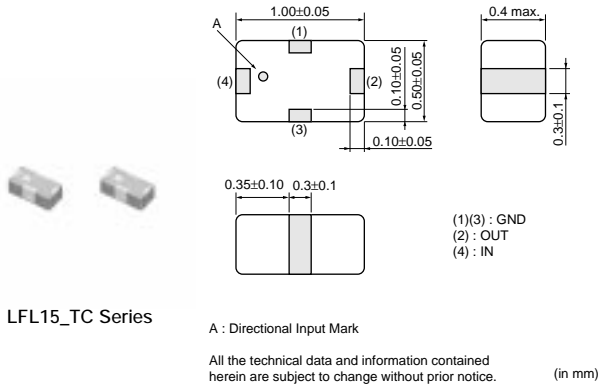

LFL15_TC Series

A : Directional Input Mark

All the technical data and information contained herein are subject to change without prior notice. (in mm)

(1)(3) : GND
(2) : OUT
(4) : IN

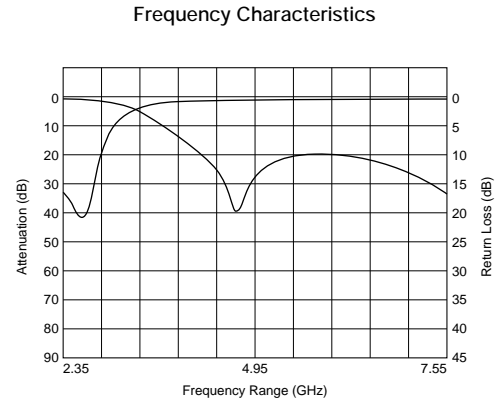
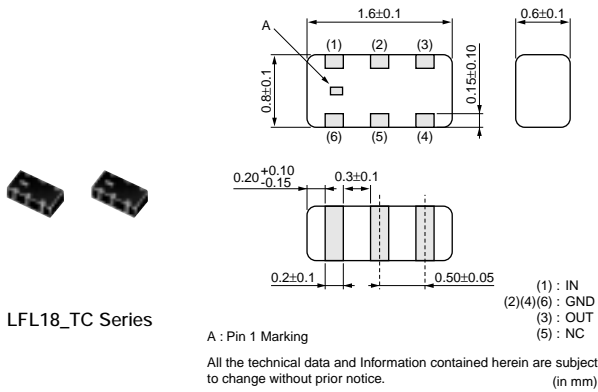



LFL18_TC Series

A : Pin 1 Marking

All the technical data and information contained herein are subject to change without prior notice. (in mm)

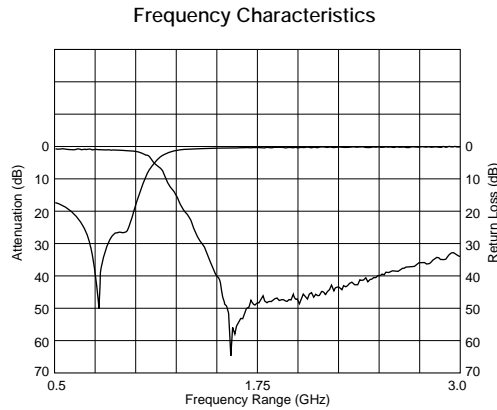
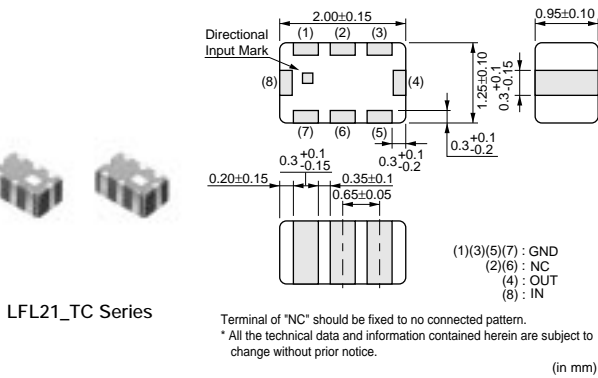
(1) : IN
(2)(4)(6) : GND
(3) : OUT
(5) : NC





LFL21_TC Series

Directional Input Mark

Terminal of "NC" should be fixed to no connected pattern.
* All the technical data and information contained herein are subject to change without prior notice. (in mm)

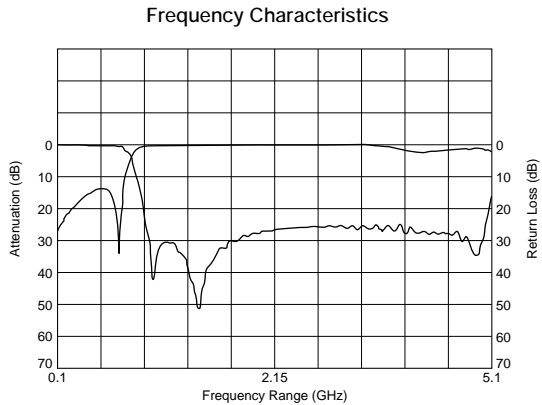
(1)(3)(5)(7) : GND
(2)(4) : NC
(6) : NC
(8) : IN



Part Number	Nominal Center Frequency (fo) (MHz)	Bandwidth (BW) (MHz)	Insertion Loss in BW (dB)	Attenuation (Absolute Value) I) (dB)	Attenuation (Absolute Value) II) (dB)
LFL152G45TC1A219	2450	fo±50	0.45 max. (at 25°C)	21 min. at 2x(fo±50.0)MHz	21 min. at 3x(fo±50.0)MHz
LFL18815MTC2A072	815.5	fo±9.5	0.80 max. (at 25°C)	35 min. at 2x(fo±9.5)MHz	30 min. at 3x(fo±9.5)MHz
LFL18924MTC1A052	924.5	fo±35	0.40 max. (at 25°C)	20 min. at 2x(fo±35.0)MHz	15 min. at 3x(fo±35.0)MHz
LFL182G45TC1A108	2450	fo±50	0.37 max. (at 25°C)	27 min. at 4800-5000MHz	25 min. at 7200-7500MHz
LFL182G45TC1A202	2450	fo±50	0.40 max. (at 25°C)	27 min. at 4800-5000MHz	30 min. at 7200-7500MHz
LFL21600MTC1A002	600	fo±250	1.37 max. (at 25°C)	20 min. at 1550-4250MHz	9 min. at 1100MHz
LFL21847MTC1A006	847.5	fo±37.5	0.75 max. (at 25°C)	30 min. at 2x(fo±37.5)MHz	30 min. at 3x(fo±37.5)MHz
LFL21902MTC1A018	902.5	fo±12.5	0.6 max. (at 25°C)	30 min. at 2x(fo±12.5)MHz	30 min. at 3x(fo±12.5)MHz
LFL211G35TC1A001	1350.0	fo±250	0.92 max. (at 25°C)	25 min. at 2300-5000MHz	-
LFL211G44TC1A014	1441.0	fo±12.0	0.47 max. (at 25°C)	31 min. at 2xfoMHz	26 min. at 3xfoMHz
LFL211G79TC1A011	1795	fo±85	0.47 max. (at 25°C)	30 min. at 2x(1747.5±37.5)MHz	25 min. at 2x(1842.5±37.5)MHz
LFL211G89TC1A015	1890	fo±10.0	0.47 max. (at 25°C)	30 min. at 2x(fo±10.0)MHz	26 min. at 3x(fo±10.0)MHz
LFL211G90TC1A008	1907.5	fo±12.5	0.47 max. (at 25°C)	30 min. at 2x(fo±12.5)MHz	25 min. at 3x(fo±12.5)MHz

Continued on the following page. ↗

Continued from the preceding page.

Part Number	Nominal Center Frequency (fo) (MHz)	Bandwidth (BW) (MHz)	Insertion Loss in BW (dB)	Attenuation (Absolute Value) I (dB)	Attenuation (Absolute Value) II (dB)
LFL211G92TC1A060	1920	fo±70	0.6 max. (at 25°C)	24 min. at 3335~3700MHz	30 min. at 3700~3820MHz
LFL212G45TC1A007	2450	fo±50	0.50 max. (at 25°C)	27 min. at 2x(fo±50.0)MHz	30 min. at 3x(fo±50.0)MHz
LFL215G25TC1A156	5250	fo±100.0	0.70 max. (at 25°C)	24 min. at 2x(fo±100)MHz	19 min. at 3x(fo±100)MHz
LFL215G37TC1A210	5375	fo±475	0.70 max. (at 25°C)	30 min. at 2x(fo±475)MHz	20 min. at 3x(fo±475)MHz
LFL215G51TC1A149	5512	fo±363	0.70 max. (at 25°C)	30 min. at 2x(fo±363)MHz	20 min. at 3x(fo±363)MHz
LFL215G78TC1A155	5787.5	fo±62.5	0.70 max. (at 25°C)	30 min. at 2x(fo±62.5)MHz	20 min. at 3x(fo±62.5)MHz

for RF/Local

Chip Multilayer LC Filters (HPF)

● LFH32_RA Series (1210)

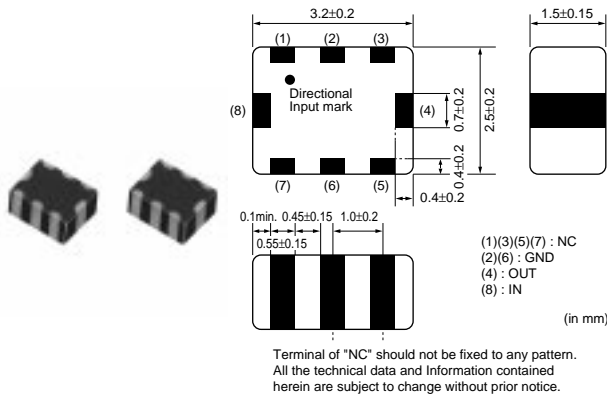

Frequency Characteristics

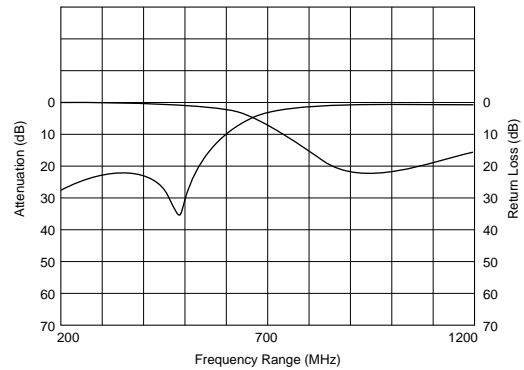

Part Number	Nominal Center Frequency (fo) (MHz)	Bandwidth (BW) (MHz)	Insertion Loss in BW (dB)	Attenuation (Absolute Value) I (dB)	Attenuation (Absolute Value) II (dB)
LFH32942MRA1A517	942.5	fo±17.5	0.5 max. (at 25°C)	4.5 min. at 480~600MHz	25 min. at 480MHz

for RF/Local

Chip Multilayer Diplexers

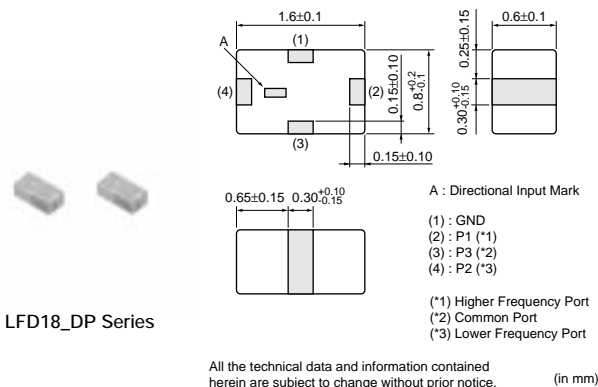

LFD18_DP Series

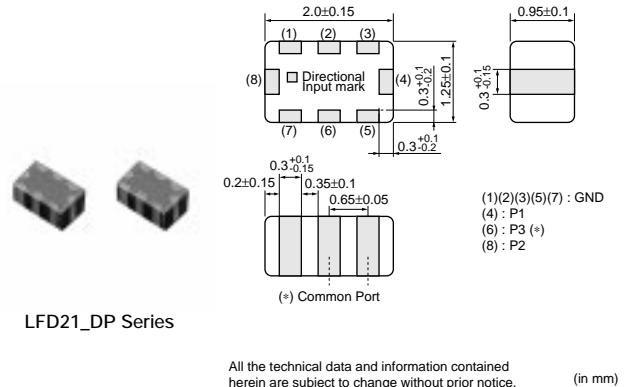

LFD21_DP Series

Part Number	Frequency Range[P1](f1) (MHz)	Frequency Range[P2](f2) (MHz)	Insertion Loss [P1-P3](in f1) (dB)	Insertion Loss [P2-P3](in f2) (dB)	Attenuation [P1-P3](in f2) (dB)	Attenuation [P2-P3](in f1) (dB)
LFD182G45DP3A299	5375 ±475.0MHz	2450 ±50.0MHz	0.60 max. (at 25°C)	0.40 max. (at 25°C)	20 min.	20 min.
LFD212G45DP3A140	5250 ±100.0MHz	2450 ±50.0MHz	0.65 max. (at 25°C)	0.50 max. (at 25°C)	20 min.	20 min.
LFD212G45DP3A151	5487.5 ±337.5MHz	2450 ±50.0MHz	0.75 max. (at 25°C)	0.50 max. (at 25°C)	20 min.	16 min.
LFD212G45DP3A188	5375 ±475.0MHz	2450 ±50.0MHz	0.75 max. (at 25°C)	0.50 max. (at 25°C)	21 min.	17 min.
LFD212G45DP4A189	2450 ±50.0MHz	5375 ±475.0MHz	0.5 max. (at 25°C)	0.75 max. (at 25°C)	17 min.	21 min.

Continued on the following page. ↗

Continued from the preceding page.

Part Number	Frequency Range[P1](f1) (MHz)	Frequency Range[P2](f2) (MHz)	Insertion Loss [P1-P3](in f1) (dB)	Insertion Loss [P2-P3](in f2) (dB)	Attenuation [P1-P3](in f2) (dB)	Attenuation [P2-P3](in f1) (dB)
LFD21859MDP1A049	1920 ±70.0MHz	859 ±35.0MHz	0.45 max. (at 25°C)	0.40 max. (at 25°C)	19 min.	20 min.
LFD21859MDP2A076	859 ±35.0MHz	1920 ±70.0MHz	0.40 max. (at 25°C)	0.45 max. (at 25°C)	20 min.	19 min.
LFD21874MDP1A084	1575.5 ±3.0MHz	874 ±51.0MHz	0.60 max. (at 25°C)	0.55 max. (at 25°C)	25 min.	23 min.
LFD21874MDP2A181	874 ±51.0MHz	1575.5 ±3.0MHz	0.55 max. (at 25°C)	0.60 max. (at 25°C)	23 min.	25 min.
LFD21884MDP1A062	1906.5 ±13.0MHz	884 ±74.0MHz	0.45 max. (at 25°C)	0.50 max. (at 25°C)	20 min.	20 min.
LFD21892MDP1A141	1850 ±140.0MHz	892 ±68.0MHz	0.60 max. (at 25°C)	0.40 max. (at 25°C)	19 min.	17 min.
LFD21892MDP2B860	892 ±68.0MHz	1850 ±140.0MHz	0.40 max. (at 25°C)	0.60 max. (at 25°C)	17 min.	19 min.
LFD21920MDP1A048	1795 ±85.0MHz	920 ±40.0MHz	0.55 max. (at 25°C)	0.50 max. (at 25°C)	20 min.	16 min.

for RF/Local

Chip Multilayer LC Filters (Trap)

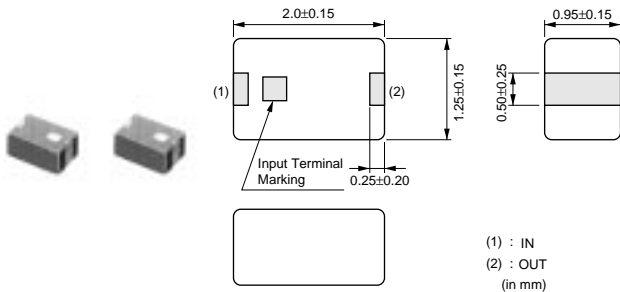

Part Number	Center Frequency of Rejection Band (MHz)	Pass Bandwidth (BW) (MHz)	Insertion Loss in BW (dB)	Attenuation (Absolute Value) (dB)
LFE21560MHA1A004	560	810-885	0.7 max. (at 25°C)	10.0 min. at 550-570MHz

for RF/Local

Chip Multilayer LC Filters (Balanced Filters)

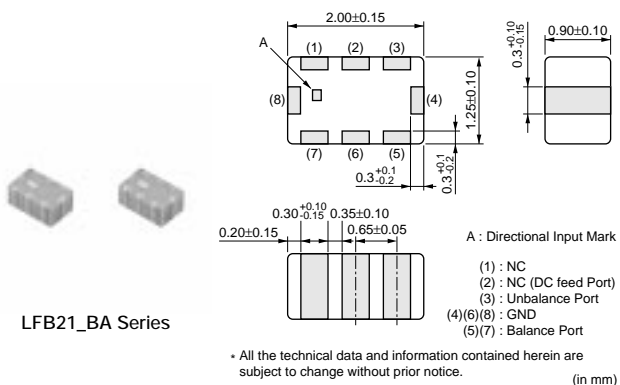

Part Number	Nominal Center Frequency (fo) (MHz)	Bandwidth (BW) (MHz)	Insertion Loss in BW (dB)	Balance Impedance (Differential) (Nom.) (ohm)	Unbalance Impedance (Nom.) (ohm)
LFB212G45BA1A220	2450.00	fo±50.00	3.5 max. (at 25°C)	34.2 -j95.0ohm (Differential) Source Impedance	50
LFB212G45BA1A234	2450.00	fo±50.00	3.5 max. (at 25°C)	50	50
LFB212G45BA1B763	2450.00	fo±50.00	3.5 max. (at 25°C)	50 +j50ohm (Differential) Source Impedance	50
LFB215G37BA1A233	5375.00	fo±475.00	2.8 max. (at 25°C)	100	50

for RF/Local

SAW Filters

● GPS

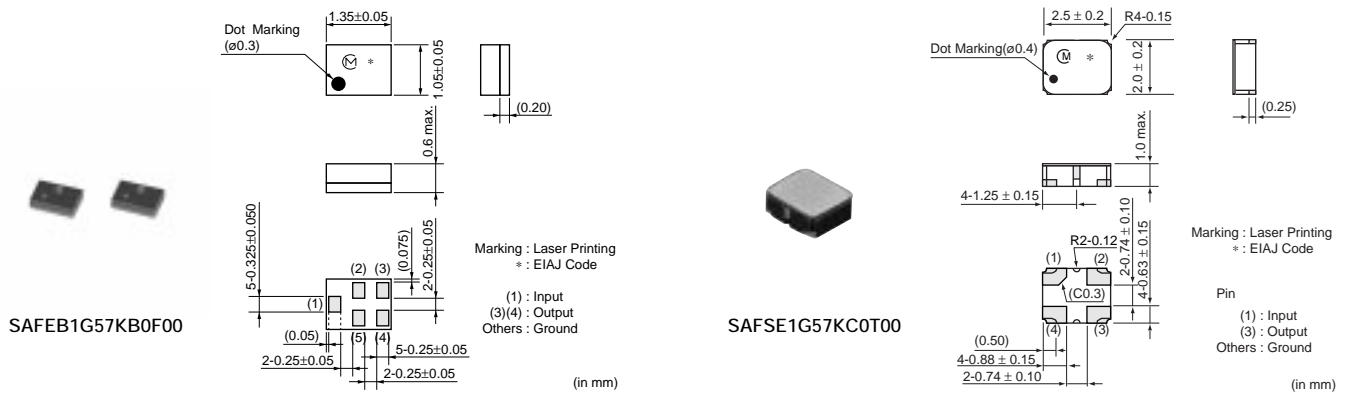

Part Number	Center Frequency (MHz)	Insertion Loss (dB)	Ripple (dB max.)	VSWR	Input Impedance	Output Impedance
SAFEB1G57KB0F00	1575.42	0.8 max. (1574.22MHz-1576.62MHz)	0.5 (1574.22MHz-1576.62MHz)	2.0max. (1574.22MHz-1576.62MHz)	50ohm	50ohm
SAFEB1G57KA0F00	1575.5	1.5 max. (1574MHz-1577MHz)	0.6 (1574MHz-1577MHz)	1.8max. (1574MHz-1577MHz)	50ohm	50ohm
SAFEB1G57FM0F00	1575.42	2.3 max. (1574.22MHz-1576.62MHz)	0.6 (1574.22MHz-1576.62MHz)	1.5max. (1574.22MHz-1576.62MHz)	50ohm	100ohm
SAFEB1G57FL0F00	1575.42	2.7 max. (1574.42MHz-1576.42MHz)	0.5 (1574.42MHz-1576.42MHz)	1.7max. (1574.42MHz-1576.42MHz)	50ohm	200ohm
SAFSE1G57KC0T00	1575.5	2.5 max. (1574MHz-1577MHz)	0.7 (1574MHz-1577MHz)	1.6max (1574MHz-1577MHz)	50ohm	50ohm
SAFSD1G57FA0T00	1575.5	1.6 max. (1574MHz-1577MHz)	0.5 (1574MHz-1577MHz)	1.6max. (1574MHz-1577MHz)	50ohm	100ohm
SAFSE1G57KA0T05	1575.5	1.6 max. (1574MHz-1577MHz)	0.7 (1574MHz-1577MHz)	1.6max. (1574MHz-1577MHz)	50ohm	50ohm
SAFSE1G57KA0T09	1575.42	2 max. (1574.42MHz-1576.42MHz)	1.5 (1574.42MHz-1576.42MHz)	1.8max. (1574.42MHz-1576.42MHz)	50ohm	50ohm

● GSM850

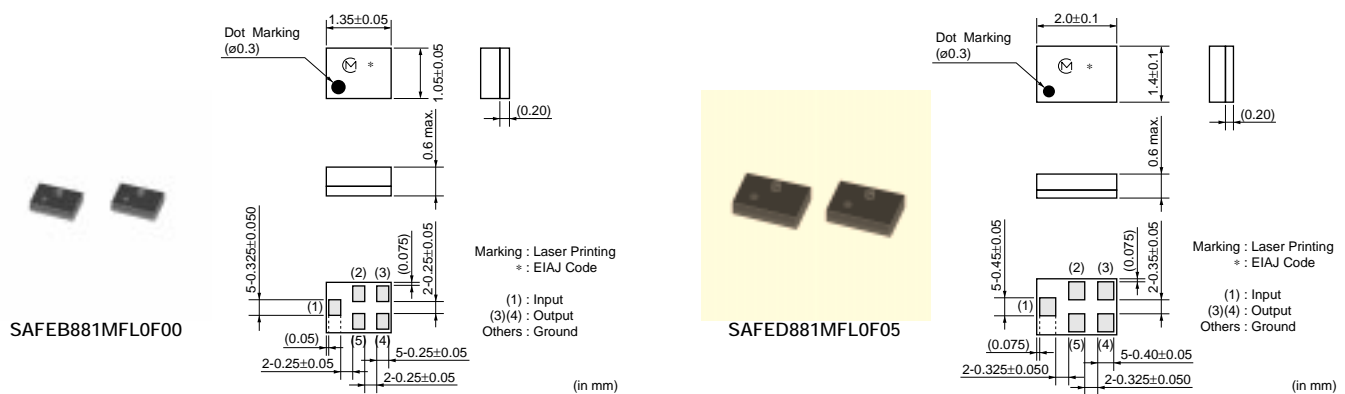

Part Number	Center Frequency (MHz)	Insertion Loss (dB)	Ripple (dB max.)	VSWR	Input Impedance	Output Impedance
SAFEB881MFL0F00	881.5	2.3 max. (869MHz-894MHz)	1.2 (869MHz-894MHz)	1.8max. (869MHz-894MHz)	50ohm	150ohm//82nH
SAFED881MFL0F05	881.5	2.0 max. (869MHz-894MHz)	1.1 (869MHz-894MHz)	1.8max. (869MHz-894MHz)	50ohm	150ohm//68nH

Continued on the following page.

△Note • This PDF catalog is downloaded from the website of Murata Manufacturing co., ltd. Therefore, it's specifications are subject to change or our products in it may be discontinued without advance notice. Please check with our sales representatives or product engineers before ordering.
• This PDF catalog has only typical specifications because there is no space for detailed specifications. Therefore, please approve our product specifications or transact the approval sheet for product specifications before ordering.

Continued from the preceding page.

Part Number	Center Frequency (MHz)	Insertion Loss (dB)	Ripple (dB max.)	VSWR	Input Impedance	Output Impedance
SAFEH881MFM0F00	881.5	2.4 max. (869MHz-894MHz)	1.5 (869MHz-894MHz)	1.9max. (869MHz-894MHz)	50ohm	150ohm//82nH
SAFEF881MAL0F00	881.5	2.6 max. (869MHz-894MHz)	1.4 (869MHz-894MHz)	1.7max. (869MHz-894MHz)	50ohm	50ohm
SAFSD881MFL0T50	881.5	3 max. (869MHz-894MHz)	1.4 (869MHz-894MHz)	2max. (869MHz-894MHz)	50ohm	200ohm//82nH

● GSM850/GSM900 Dual Band

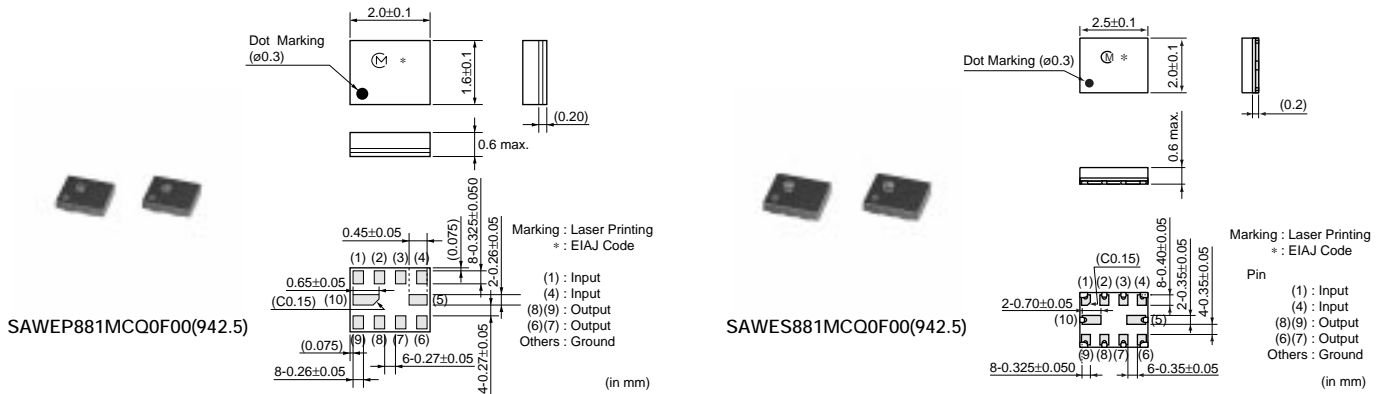

Part Number	Center Frequency (MHz)	Insertion Loss (dB)	Ripple (dB max.)	VSWR	Input Impedance	Output Impedance
SAWEP881MCQ0F00(881.5)	881.5	2.0 max. (869MHz-894MHz)	1.1 (869MHz-894MHz)	2.0max. (869MHz-894MHz)	50ohm	150ohm//82nH
SAWEP881MCQ0F00(942.5)	942.5	2.4 max. (925MHz-960MHz)	1.5 (925MHz-960MHz)	2.1max. (925MHz-960MHz)	50ohm	150ohm//82nH
SAWEP881MCP0F00(881.5)	881.5	2.0 max. (869MHz-894MHz)	1.1 (869MHz-894MHz)	2.0max. (869MHz-894MHz)	50ohm	150ohm//82nH
SAWEP881MCP0F00(942.5)	942.5	2.4 max. (925MHz-960MHz)	1.5 (925MHz-960MHz)	2.1max. (925MHz-960MHz)	50ohm	150ohm//82nH
SAWES881MCQ0F00(881.5)	881.5	2.1 max. (869MHz-894MHz)	1.0 (869MHz-894MHz)	1.9max. (869MHz-894MHz)	50ohm	150ohm//68nH
SAWES881MCQ0F00(942.5)	942.5	2.9 max. (925MHz-960MHz)	1.7 (925MHz-960MHz)	2.2max. (925MHz-960MHz)	50ohm	150ohm//56nH

● GSM850/GSM1900 Dual Band

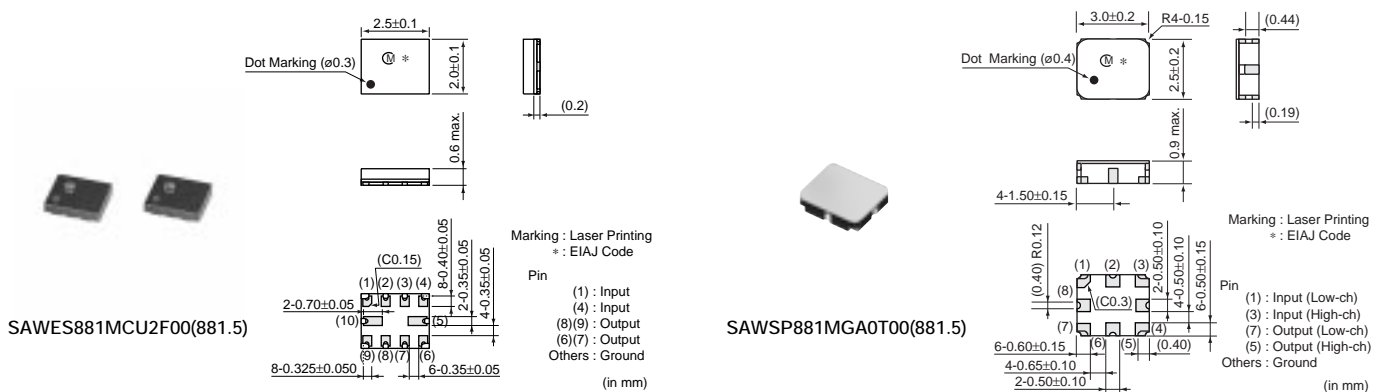

Part Number	Center Frequency (MHz)	Insertion Loss (dB)	Ripple (dB max.)	VSWR	Input Impedance	Output Impedance
SAWES881MCU2F00(881.5)	881.5	2.1 max. (869MHz-894MHz)	1.0 (869MHz-894MHz)	1.9max. (869MHz-894MHz)	50ohm	150ohm//68nH
SAWES881MCU2F00(1960)	1960	3 max. (1930MHz-1990MHz)	1.9 (1930MHz-1990MHz)	2.4max. (1930MHz-1990MHz)	50ohm	150ohm//22nH
SAWSP881MGA0T00(881.5)	881.5	2.9 max. (869MHz-894MHz)	1.5 (869MHz-894MHz)	2max. (869MHz-894MHz)	50ohm	50ohm
SAWSP881MGA0T00(1960)	1960	3.2 max. (1930MHz-1990MHz)	2 (1930MHz-1990MHz)	2.4max. (1930MHz-1990MHz)	50ohm	50ohm
SAWSU881MCQ0T01(881.5)	881.5	3 max. (869MHz-894MHz)	1.8 (869MHz-894MHz)	2max. (869MHz-894MHz)	50ohm	200ohm//56nH
SAWSU881MCQ0T01(1960)	1960	3 max. (1930MHz-1990MHz)	2.4 (1930MHz-1990MHz)	2.2max. (1930MHz-1990MHz)	50ohm	200ohm//15nH

● GSM900

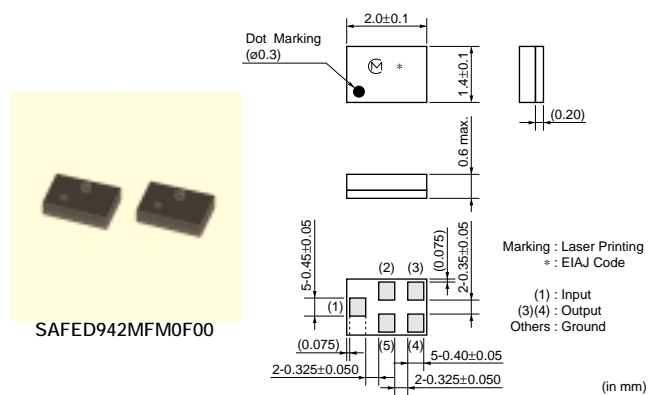
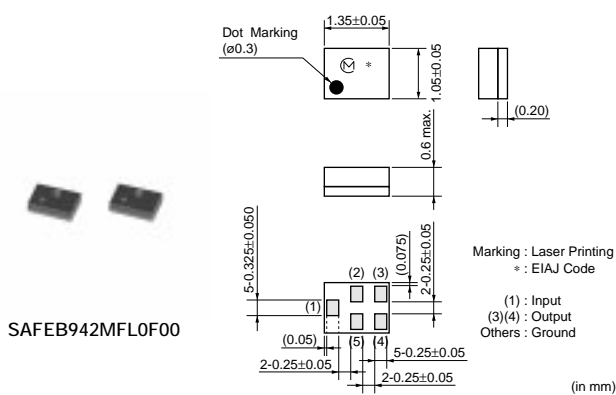

Part Number	Center Frequency (MHz)	Insertion Loss (dB)	Ripple (dB max.)	VSWR	Input Impedance	Output Impedance
SAFEB942MFL0F00	942.5	2.7 max. (925MHz-960MHz)	1.7 (925MHz-960MHz)	2max. (925MHz-960MHz)	50ohm	150ohm//82nH
SAFED942MFM0F00	942.5	2.2 max. (925MHz-960MHz)	1.3 (925MHz-960MHz)	2.1max. (925MHz-960MHz)	50ohm	150ohm//82nH
SAFEH942MFN0F00	942.5	2.7 max. (925MHz-960MHz)	1.8 (925MHz-960MHz)	2max. (925MHz-960MHz)	50ohm	150ohm//82nH
SAFEF942MAL0F00	942.5	3 max. (925MHz-960MHz)	1.7 (925MHz-960MHz)	2.1max. (925MHz-960MHz)	50ohm	50ohm
SAFSD942MFM0T00	942.5	3.2 max. (925MHz-960MHz)	2.2 (925MHz-960MHz)	2.3max. (925MHz-960MHz)	50ohm	200ohm//82nH
SAFSD942MCL0T00	942.5	3.3 max. (925MHz-960MHz)	1.8 (925MHz-960MHz)	2max. (925MHz-960MHz)	50ohm	50ohm
SAFSE942MAL0T05	942.5	3.2 max. (925MHz-960MHz)	2 (925MHz-960MHz)	2.2max. (925MHz-960MHz)	50ohm	50ohm

△Note • This PDF catalog is downloaded from the website of Murata Manufacturing co., Ltd. Therefore, it's specifications are subject to change or our products in it may be discontinued without advance notice. Please check with our sales representatives or product engineers before ordering.
 • This PDF catalog has only typical specifications because there is no space for detailed specifications. Therefore, please approve our product specifications or transact the approval sheet for product specifications before ordering.

● GSM900/GSM1800 Dual Band

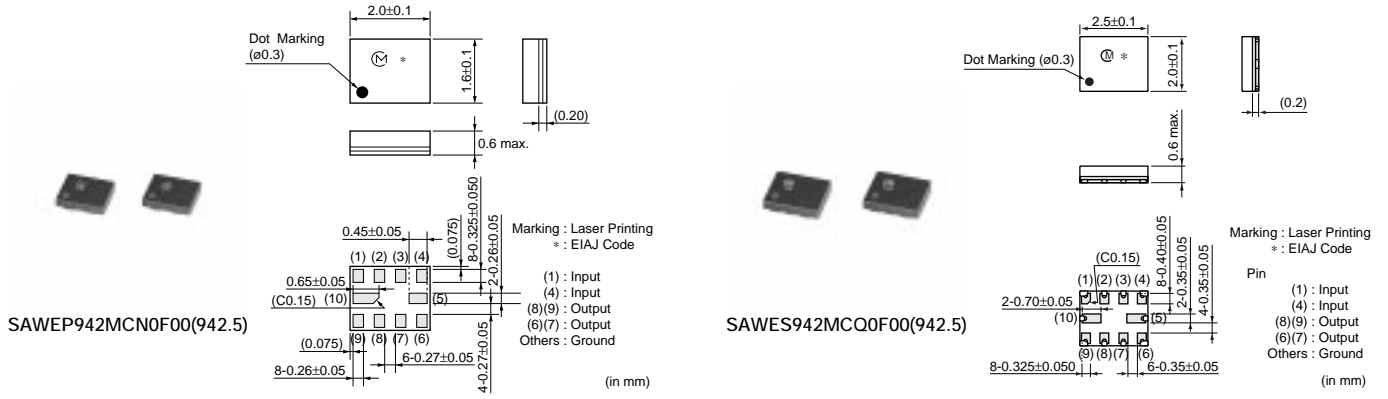

Part Number	Center Frequency (MHz)	Insertion Loss (dB)	Ripple (dB max.)	VSWR	Input Impedance	Output Impedance
SAWEP942MCN0F00(942.5)	942.5	2.3 max. (925MHz-960MHz)	1.3 (925MHz-960MHz)	2.1max. (925MHz-960MHz)	50ohm	150ohm//82nH
SAWEP942MCN0F00(1842.5)	1842.5	2.2 max. (1805MHz-1880MHz)	1.2 (1805MHz-1880MHz)	2.2max. (1805MHz-1880MHz)	50ohm	150ohm//15nH
SAWES942MCQ0F00(942.5)	942.5	2.9 max. (925MHz-960MHz)	1.7 (925MHz-960MHz)	2.2max. (925MHz-960MHz)	50ohm	150ohm//56nH
SAWES942MCQ0F00(1842.5)	1842.5	2.6 max. (1805MHz-1880MHz)	1.7 (1805MHz-1880MHz)	2.4max. (1805MHz-1880MHz)	50ohm	150ohm//15nH
SAWES942MCM0F00(942.5)	942.5	2.8 max. (925MHz-960MHz)	1.5 (925MHz-960MHz)	2max. (925MHz-960MHz)	50ohm	150ohm//56nH
SAWES942MCM0F00(1842.5)	1842.5	3 max. (1805MHz-1880MHz)	1.8 (1805MHz-1880MHz)	2.2max. (1805MHz-1880MHz)	50ohm	150ohm//18nH
SAWES942MCQ0F05(942.5)	942.5	2.9 max. (925MHz-960MHz)	1.7 (925MHz-960MHz)	2.2max. (925MHz-960MHz)	50ohm	150ohm//56nH
SAWES942MCQ0F05(1842.5)	1842.5	2.6 max. (1805MHz-1880MHz)	1.7 (1805MHz-1880MHz)	2.4max. (1805MHz-1880MHz)	50ohm	150ohm//15nH
SAWSP942MLD0T00(942.5)	942.5	3 max. (925MHz-960MHz)	2 (925MHz-960MHz)	2.5max. (925MHz-960MHz)	50ohm	50ohm
SAWSP942MLD0T00(1842.5)	1842.5	3.2 max. (1805MHz-1880MHz)	2 (1805MHz-1880MHz)	2.5max. (1805MHz-1880MHz)	50ohm	50ohm
SAWSU942MCS0T01(942.5)	942.5	3.2 max. (925MHz-960MHz)	2.2 (925MHz-960MHz)	2.4max. (925MHz-960MHz)	50ohm	200ohm//47nH
SAWSU942MCS0T01(1842.5)	1842.5	3.2 max. (1805MHz-1880MHz)	2.2 (1805MHz-1880MHz)	2.5max. (1805MHz-1880MHz)	50ohm	200ohm//16nH

● GSM1800

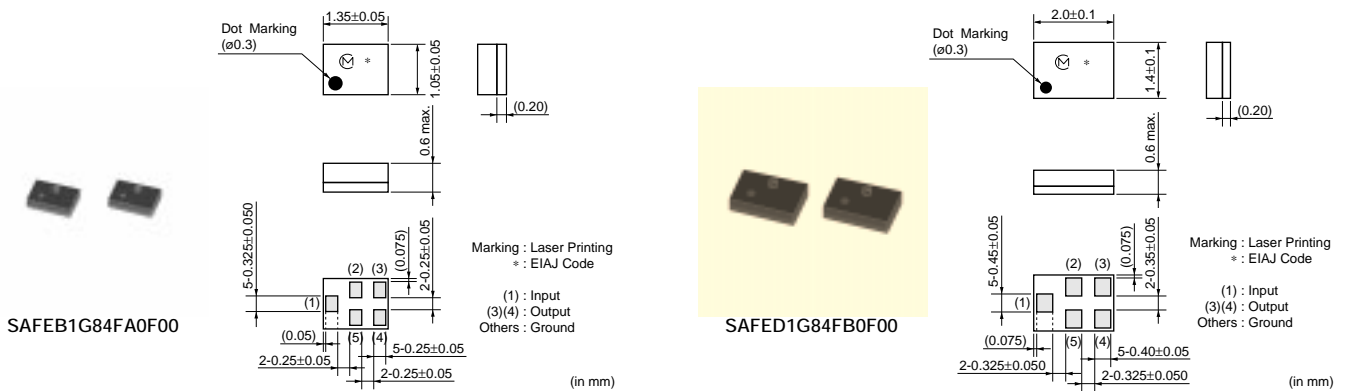

△Note • This PDF catalog is downloaded from the website of Murata Manufacturing Co., Ltd. Therefore, it's specifications are subject to change or our products in it may be discontinued without advance notice. Please check with our sales representatives or product engineers before ordering.
 • This PDF catalog has only typical specifications because there is no space for detailed specifications. Therefore, please approve our product specifications or transact the approval sheet for product specifications before ordering.

Part Number	Center Frequency (MHz)	Insertion Loss (dB)	Ripple (dB max.)	VSWR	Input Impedance	Output Impedance
SAFE1G84FA0F00	1842.5	2.5 max. (1805-1880MHz)	1.5 (1805MHz-1880MHz)	2.2max. (1805MHz-1880MHz)	50ohm	150ohm//18nH
SAFED1G84FB0F00	1842.5	2.0 max. (1805-1880MHz)	1.3 (1805MHz-1880MHz)	2.5max. (1805MHz-1880MHz)	50ohm	150ohm//18nH
SAFEH1G84FB0F00	1842.5	2.5 max. (1805-1880MHz)	1.5 (1805MHz-1880MHz)	2.2max. (1805MHz-1880MHz)	50ohm	150ohm//18nH
SAFEF1G84AA0F00	1842.5	2.8 max. (1805-1880MHz)	1.7 (1805MHz-1880MHz)	2.2max. (1805MHz-1880MHz)	50ohm	50ohm
SAFSE1G84KA0T00	1842.5	3.2 max. (1805-1880MHz)	2.2 (1805MHz-1880MHz)	2.8max. (1805MHz-1880MHz)	50ohm	50ohm
SAFSD1G84FA0T00	1842.5	3 max. (1805-1880MHz)	2 (1805MHz-1880MHz)	2.7max. (1805MHz-1880MHz)	50ohm	200ohm//27nH
SAFSD1G84CB0T00	1842.5	3.8 max. (1805-1880MHz)	2 (1805MHz-1880MHz)	2.7max. (1805MHz-1880MHz)	50ohm	50ohm
SAFCC1G74KA0T00	1747.5	4.2 max. (1710MHz-1785MHz)	2.6 (1710MHz-1785MHz)	2.5max. (1710MHz-1785MHz)	50ohm	50ohm

● GSM1800/GSM1900 Dual Band

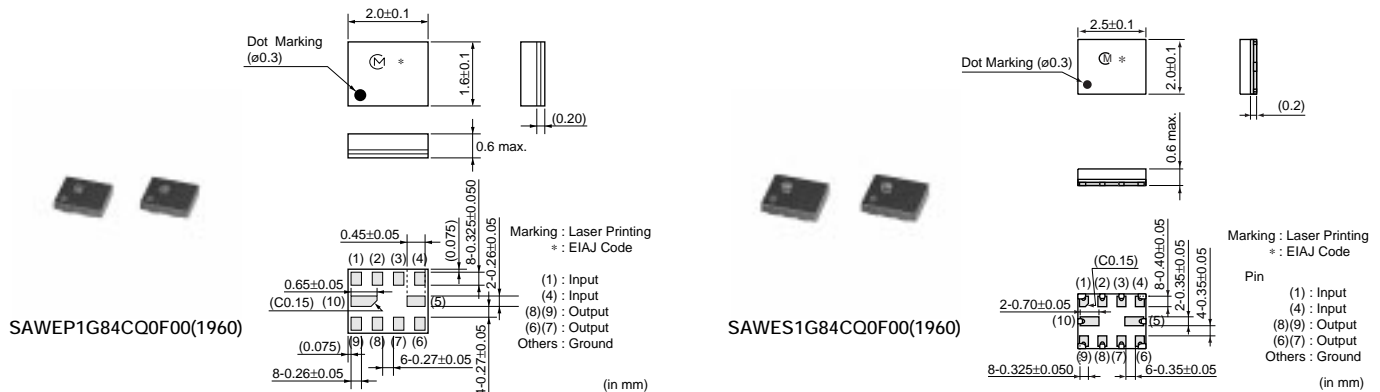

Part Number	Center Frequency (MHz)	Insertion Loss (dB)	Ripple (dB max.)	VSWR	Input Impedance	Output Impedance
SAWEP1G84CQ0F00(1842.5)	1842.5	2.5 max. (1805MHz-1880MHz)	1.5 (1805MHz-1880MHz)	2.2max. (1805MHz-1880MHz)	50ohm	150ohm//15nH
SAWEP1G84CQ0F00(1960)	1960	2.6 max. (1930MHz-1990MHz)	1.8 (1930MHz-1990MHz)	2.2max. (1930MHz-1990MHz)	50ohm	150ohm//18nH
SAWES1G84CQ0F00(1842.5)	1842.5	2.6 max. (1805MHz-1880MHz)	1.7 (1805MHz-1880MHz)	2.4max. (1805MHz-1880MHz)	50ohm	150ohm//15nH
SAWES1G84CQ0F00(1960)	1960	3.0 max. (1930MHz-1990MHz)	1.9 (1930MHz-1990MHz)	2.4max. (1930MHz-1990MHz)	50ohm	150ohm//22nH

△Note • This PDF catalog is downloaded from the website of Murata Manufacturing co., Ltd. Therefore, it's specifications are subject to change or our products in it may be discontinued without advance notice. Please check with our sales representatives or product engineers before ordering.
• This PDF catalog has only typical specifications because there is no space for detailed specifications. Therefore, please approve our product specifications or transact the approval sheet for product specifications before ordering.

● GSM1900

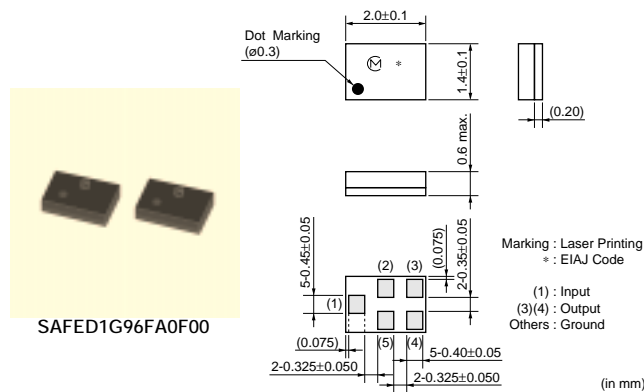
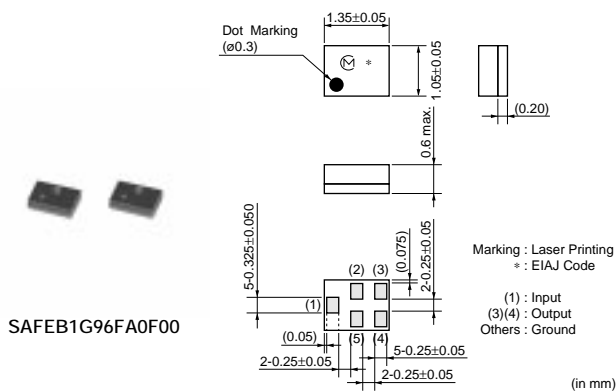

Part Number	Center Frequency (MHz)	Insertion Loss (dB)	Ripple (dB max.)	VSWR	Input Impedance	Output Impedance
SAFEB1G96FA0F00	1960	2.6 max. (1930-1990MHz)	1.8 (1930MHz-1990MHz)	2.2max. (1930MHz-1990MHz)	50ohm	150ohm//27nH
SAFED1G96FA0F00	1960	2.9 max. (1930-1990MHz)	1.8 (1930MHz-1990MHz)	2.4max. (1930MHz-1990MHz)	50ohm	150ohm//18nH
SAFEH1G96FB0F00	1960	2.6 max. (1930-1990MHz)	1.8 (1930MHz-1990MHz)	2.2max. (1930MHz-1990MHz)	50ohm	150ohm//22nH
SAFEF1G96AA0F00	1960	2.8 max. (1930-1990MHz)	1.7 (1930MHz-1990MHz)	2.4max. (1930MHz-1990MHz)	50ohm	50ohm
SAFSE1G96KD0T00	1960	3 max. (1930-1990MHz)	2 (1930MHz-1990MHz)	2.5max. (1930MHz-1990MHz)	50ohm	50ohm
SAFSD1G96FB0T00	1960	3 max. (1930-1990MHz)	2.4 (1930MHz-1990MHz)	2.4max. (1930MHz-1990MHz)	50ohm	200ohm//22nH

Filters for Communication Equipment

● J-CDMA

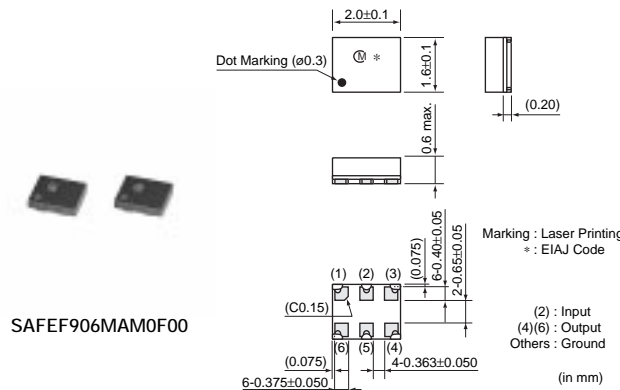
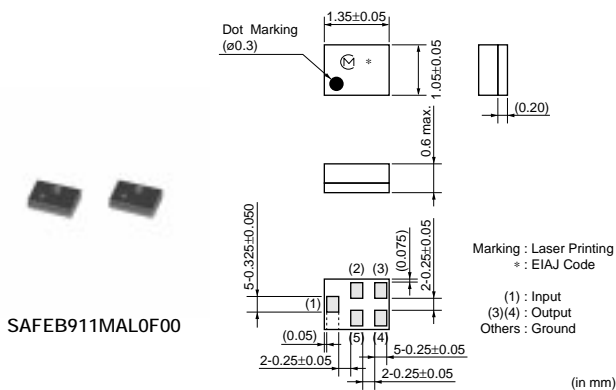

Part Number	Center Frequency (MHz)	Insertion Loss (dB)	Ripple (dB max.)	VSWR	Input Impedance	Output Impedance
SAFEB911MAL0F00	911.5	2.2 max. (898MHz-925MHz)	1.2 (898MHz-925MHz)	2.0max. (898MHz-925MHz)	50ohm	50ohm
SAFEB856MCM0F00	856.5	2.2 max. (843MHz-870MHz)	1.2 (843MHz-870MHz)	2.0max. (843MHz-870MHz)	50ohm	100ohm
SAFEF906MAM0F00	906	3.2 max. (887MHz-925MHz)	1.5 (887MHz-925MHz)	2.4max. (887MHz-925MHz)	50ohm	50ohm
SAFSE906MAM0T00	906	4 max. (887MHz-925MHz)	2.5 (887MHz-925MHz)	2.4max. (887MHz-925MHz)	50ohm	50ohm
SAFSE851MKB0T00	851	3.4 max. (832MHz-870MHz)	2.5 (832MHz-870MHz)	2.2max. (832MHz-870MHz)	50ohm	50ohm
SAFSD906MCL0T00	906	4.2 max. (887MHz-925MHz)	2.5 (887MHz-925MHz)	2.8max. (887MHz-925MHz)	50ohm	50ohm

Continued on the following page.

Continued from the preceding page.

Part Number	Center Frequency (MHz)	Insertion Loss (dB)	Ripple (dB max.)	VSWR	Input Impedance	Output Impedance
SAFSD851MXA0T00	851	2.6 max. (832MHz~870MHz)	1.9 (832MHz~870MHz)	2.7max. (832MHz~870MHz)	50ohm	100ohm//56nH

● PCS(CDMA)

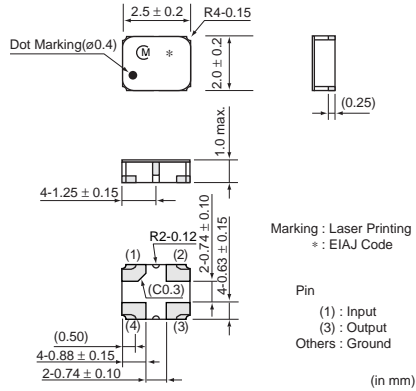

Part Number	Center Frequency (MHz)	Insertion Loss (dB)	Ripple (dB max.)	VSWR	Input Impedance	Output Impedance
SAFSE1G88KC0T00	1880	5 max. (1850MHz~1910MHz)	3.5 (1850MHz~1910MHz)	2.2max. (1850MHz~1910MHz)	50ohm	50ohm
SAFSD1G96FL0T00	1960	4 max. (1930MHz~1990MHz)	2 (1930MHz~1990MHz)	2.1max. (1930MHz~1990MHz)	50ohm	100ohm

● W-CDMA

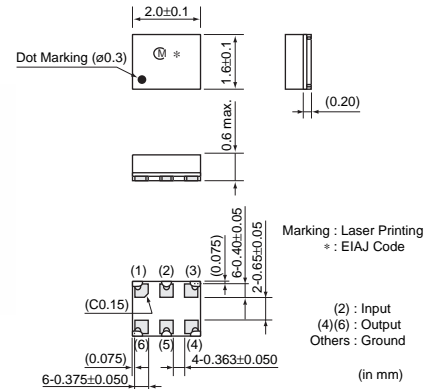
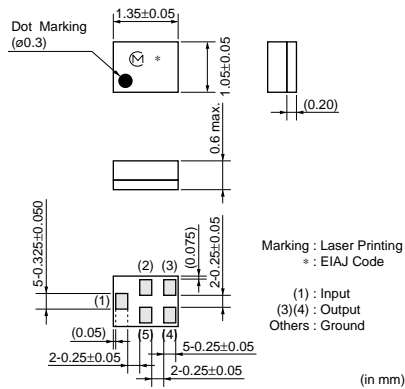

Part Number	Center Frequency (MHz)	Insertion Loss (dB)	Ripple (dB max.)	VSWR	Input Impedance	Output Impedance
SAFEB2G14FA0F00	2140	2.3 max. (2110~2170MHz)	1.2 (2110MHz~2170MHz)	1.8max. (2110MHz~2170MHz)	50ohm	200ohm//27nH
SAFEB1G95KA0F00	1950	2.9 max. (1920~1980MHz)	2.0 (1920MHz~1980MHz)	2max. (1920MHz~1980MHz)	50ohm	50ohm
SAFEB1G95FL0F00	1950	2.6 max. (1920~1980MHz)	1.3 (1920MHz~1980MHz)	1.8max. (1920MHz~1980MHz)	200ohm//27nH	50ohm
SAFEH2G14FA0F00	2140	2.3 max. (2110~2170MHz)	1.2 (2110MHz~2170MHz)	1.8max. (2110MHz~2170MHz)	50ohm	200ohm//27nH
SAFEH1G95FL0F00	1950	2.8 max. (1920~1980MHz)	1.5 (1920MHz~1980MHz)	2max. (1920MHz~1980MHz)	200ohm//33nH	50ohm
SAFEF1G95KA0F00	1950	3 max. (1920~1980MHz)	1.7 (1920MHz~1980MHz)	2max. (1920MHz~1980MHz)	50ohm	50ohm

Continued on the following page.

△Note • This PDF catalog is downloaded from the website of Murata Manufacturing Co., Ltd. Therefore, its specifications are subject to change or our products in it may be discontinued without advance notice. Please check with our sales representatives or product engineers before ordering.
• This PDF catalog has only typical specifications because there is no space for detailed specifications. Therefore, please approve our product specifications or transact the approval sheet for product specifications before ordering.

