

**CLASS 7
2 AMP SWITCHING
IN THE WORLDS
SMALLEST PACKAGE.
SPDT, DPDT.**

ACTUAL SIZE

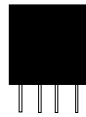

The Class 7 Subminiature high reliability industrial grade relay has excellent R.F. switching characteristics.



AVAILABLE WITH SPDT OR DPDT BIFURCATED GOLD CLAD SILVER-PALLADIUM CROSS BAR CONTACTS- RATED FOR LOW LEVEL TO 2.0 AMP SWITCHING.

REQUIRES ONLY .155 SQUARE INCH OF CIRCUIT BOARD SPACE.

TOTAL VOLUME OF LESS THAN A CUBIC CENTIMETER.

CONFORMS TO FCC PART 68.302. 1500 V PEAK SURGE RESISTANCE.

CONFORMS TO FCC PART 68.304. 1000 V DIELECTRIC WITHSTANDING VOLTAGE..

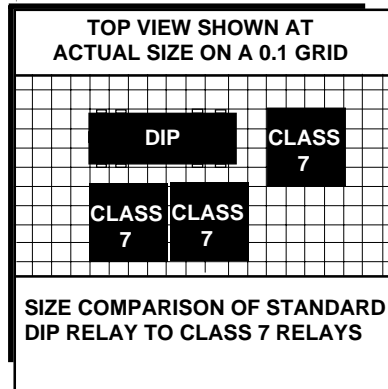

The Class 7 relays can be densely packed together without magnetic interaction from adjacent relays.

PC BOARD PATTERN

Drill Plan (TOP VIEW)

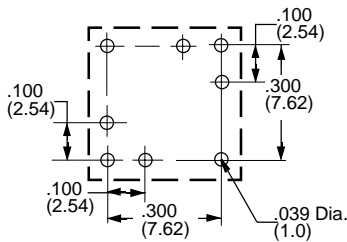

OUTLINE DIMENSIONS

Dimensions are in "INCHES" and (MILLIMETERS)

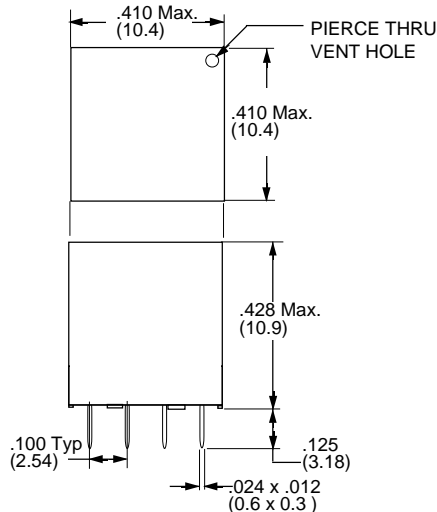

**WIRING DIAGRAM
BOTTOM VIEW**

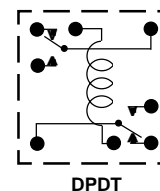
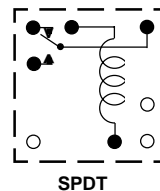

SPECIFICATIONS CLASS 7

COIL

Coil Voltages
 Pull-in Voltage: 80% of Nominal Voltage or less
 Dropout: 10 % of Nominal Voltage or More
 Max. allowed coil voltage: 120% of nominal voltage, duty cycle: 100%.
 Nominal Power: 327 Milliwatts max., min sensitivity: 200 milliwatts.
 Max. coil dissipation 0.75 watts.
 Coil Resistance range: ±10%

CONTACTS

Contact Configuration: SPDT, DPDT
 Contact Rating: SPDT: 50uA @ 50mV, 2A , 24VDC, 2A, 120VAC, DPDT: 50uA @ 50mV, 2A, 24VDC, 0.6A, 100VAC, Gold Clad Silver Palladium.
 Contact Material: Gold Clad Silver Palladium.
 Contact Resistance: Initial 50 mΩ
 100 Milliohms max @ 6VDC 10 Milliamps.

TIMING

Operate Time: 4.0 mS Max. @ Nominal Voltage. Typ.
 Release Time: 5.0 mS Max. @ Nominal Voltage. Typ

DIELECTRIC STRENGTH

All Mutually Insulated Points: 500 VAC for 1 Minute, 1 Milliamp max. leakage, or 600VAC for 1 Second, 1 Milliamp leakage.
 Surge Test: Meets FCC 68.302 (1500V Surge) and 68.304 (1000V Dielectric).
 Insulation Resistance: 500 VDC Exceeds 1000 Megohms.

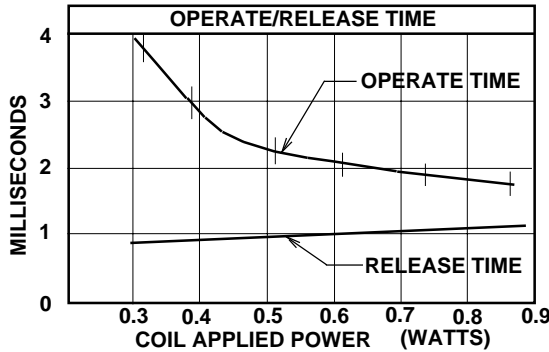

R.F. PERFORMANCE			
Frequency (MHz)	Insertion Loss (dB)	VSWR	Isolation (dB)
	Common to N.O. or N.C. Contacts	Common to N.O. or N.C. Contacts	N.O. or N.C. Contacts to Coil
10	0.05	1.03:1	65
50	0.10	1.04:1	50
100	0.30	1.05:1	42
200	0.50	1.06:1	35
300	0.60	1.07:1	31
400	0.65	1.08:1	29
500	0.75	1.10:1	28

TEMPERATURE

Operating: -35°C to +70°C

VIBRATION RESISTANCE

Functional: 15 g's, 10 to 2000 Hz, No contact opening > 10 uS
 Max. contact chatter
 Destructive: 50 g'S.

SHOCK RESISTANCE

Functional: 50g's 6mS half sine
 Mechanical: Destructive: 150 g's.

LIFE

Mechanical: 100 Million Operations
 Electrical: 100,000 Operations- 2 Amp 24VDC, 1.0 AMP 120VAC (Rated Load).

MISCELLANEOUS

Terminal Finish: Terminals are solder Coated and Epoxy free to provide excellent solderability. Max. exposure to soldering temperature is 5 seconds @ 250°C. After cleaning process, pierce a small hole in cover for venting.
 Mounting Position: Any
 Enclosure: UL, 94V-O Plastic, Epoxy Sealed.
 Weight: 2.7 Grams . (.095 oz.)

After cleaning process, pierce 0.40 (1mm) hole in cover for venting.

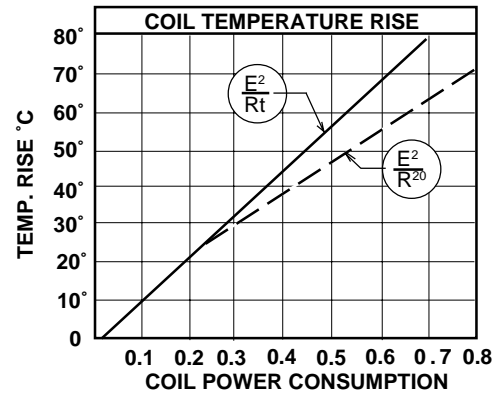

$$\frac{E^2}{R_t} = \frac{\text{COIL VOLTAGE}^2}{\text{COIL RESIST. VALUE AFTER TEMP. WAS RAISED}}$$

$$\frac{E^2}{R^{20}} = \frac{\text{COIL VOLTAGE}^2}{\text{COIL RESIST. VALUE AT } 20^\circ\text{C}}$$

Part Numbers	Contact Configuration	COIL - Measured at 25°C			CROSS REFERENCE
		Nominal Input Voltage	Nominal Resistance (Ohms)	Nominal Power (mW)	
W7PCX-1 W7PCX-3 W7PCX-4	SPDT	5 VDC	75	330	MMS105 MMS112 MMS124
	SPDT	12 VDC	440	330	
	SPDT	24 VDC	1550	370	
W7PCX-5 W7PCX-7 W7PCX-8	DPDT	5 VDC	75	330	MMS205 MMS212 MMS224
	DPDT	12 VDC	440	330	
	DPDT	24 VDC	1550	370	

PART NUMBERS SHOWN ALSO AVAILABLE THRU STOCKING DISTRIBUTION.