

FEATURES

- * 0.3 inch (7.62 mm) DIGIT HEIGHT
- * CONTINUOUS UNIFORM SEGMENTS
- * LOW POWER REQUIREMENT
- * EXCELLENT CHARACTERS APPEARANCE
- * HIGH BRIGHTNESS & HIGH CONTRAST
- * WIDE VIEWING ANGLE
- * SOLID STATE RELIABILITY
- * CATEGORIZED FOR LUMINOUS INTENSITY
- * **LEAD-FREE PACKAGE**

DESCRIPTION

The LTP-3862G is a 0.3 inch (7.62 mm) digit height dual digit 16-segment alphanumeric display. This device uses Green LED chips (GaP epi on GaP substrate). The display has black face and white segments.

DEVICE

PART NO.	DESCRIPTION
GREEN	Multiplex Common Anode
LTP-3862G	Rt. Hand Decimal

PACKAGE DIMENSIONS

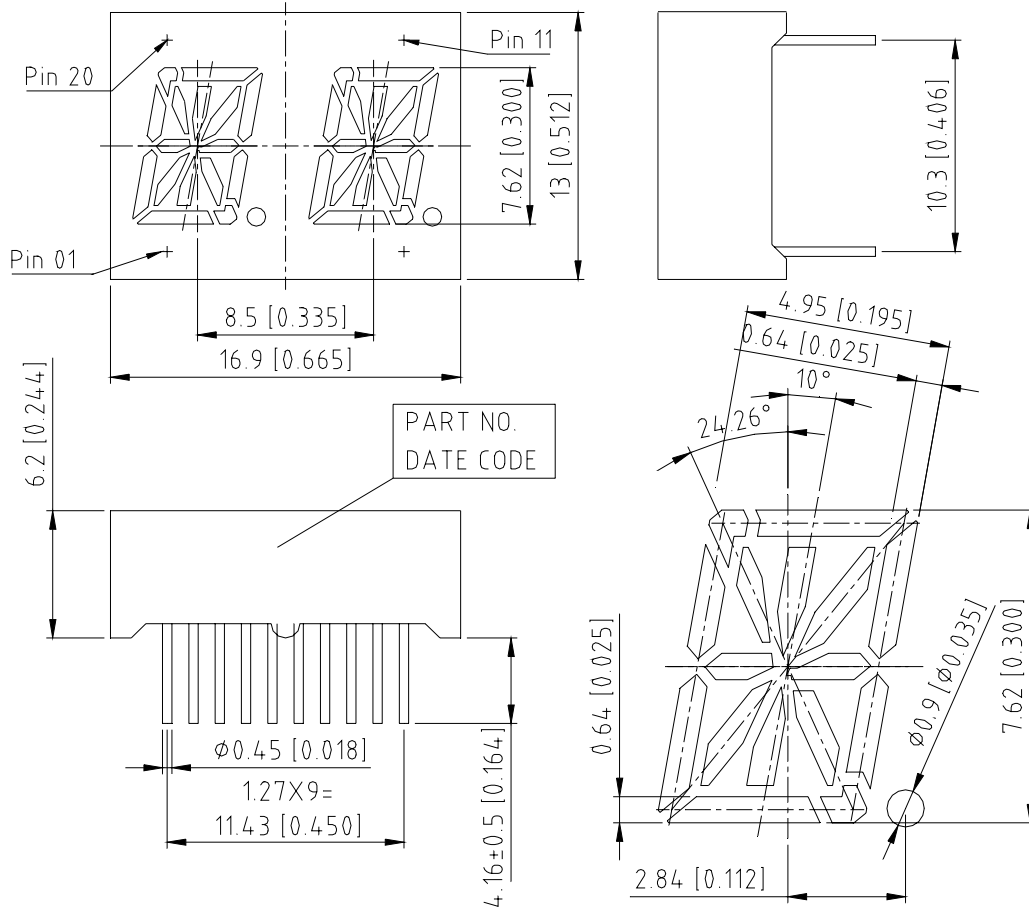

NOTES: All dimensions are in millimeters. Tolerances are $\pm 0.25\text{mm}$ (0.01") unless otherwise noted.

INTERNAL CIRCUIT DIAGRAM

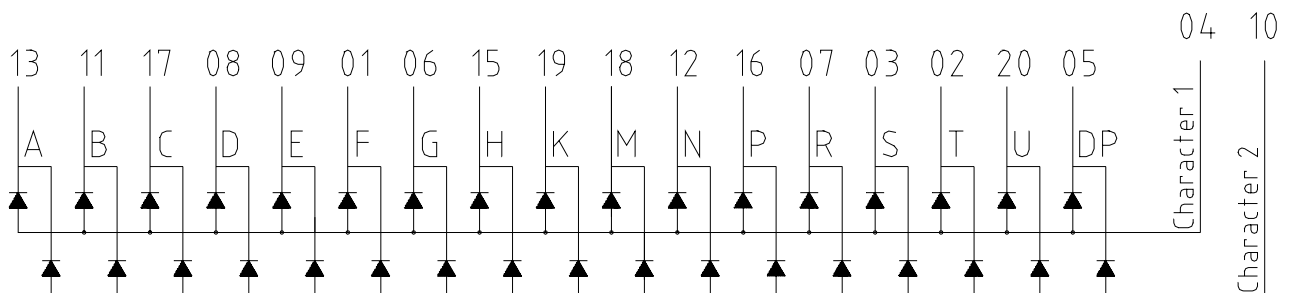

PIN CONNECTION

No.	CONNECTION
1	CATHODE F
2	CATHODE T
3	CATHODE S
4	COMMON ANODE (Digit 1)
5	CATHODE DP
6	CATHODE G
7	CATHODE R
8	CATHODE D
9	CATHODE E
10	COMMON ANODE (Digit 2)
11	CATHODE B
12	CATHODE N
13	CATHODE A
14	NO CONNECTION
15	CATHODE H
16	CATHODE P
17	CATHODE C
18	CATHODE M
19	CATHODE K
20	CATHODE U

ABSOLUTE MAXIMUM RATING

PARAMETER	MAXIMUM RATING	UNIT
Power Dissipation Per Segment	75	mW
Peak Forward Current Per Segment (Frequency 1Khz, 10% duty cycle)	100*	mA
Continuous Forward Current Per Segment	25	mA
Forward Current Derating from 25 ⁰ C	0.33	mA/ ⁰ C
Reverse Voltage Per Segment	5	V
Operating Temperature Range	-35 ⁰ C to +85 ⁰ C	
Storage Temperature Range	-35 ⁰ C to +85 ⁰ C	
Soldering Conditions : 1/16 inch below seating plane for 3 seconds at 260 ⁰ C		

* see figure 5 to establish pulsed condition

ELECTRICAL / OPTICAL CHARACTERISTICS AT T_A=25⁰C

PARAMETER	SYMBOL	MIN.	TYP.	MAX.	UNIT	TEST CONDITION
Average Luminous Intensity Per Segment	I _v	800	2000		μcd	I _F =10mA
Peak Emission Wavelength	λ _p		565		nm	I _F =20mA
Spectral Line Half-Width	Δλ		30		nm	I _F =20mA
Dominant Wavelength	λ _d		569		nm	I _F =20mA
Forward Voltage Per Segment	V _F		2.1	2.6	V	I _F =20mA
Reverse Current Per Segment	I _R			100	μA	V _R =5V
Luminous Intensity Matching Ratio	I _v -m			2:1		I _F =10mA

Note: Luminous intensity is measured with a light sensor and filter combination that approximates the CIE (Commision Internationale De L'Eclairage) eye-response curve.

TYPICAL ELECTRICAL / OPTICAL CHARACTERISTIC CURVES

(25°C Ambient Temperature Unless Otherwise Noted)

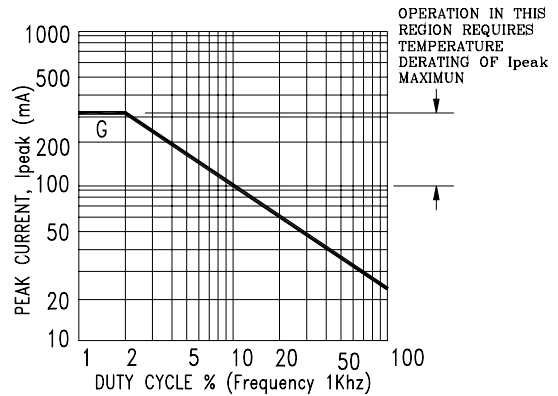
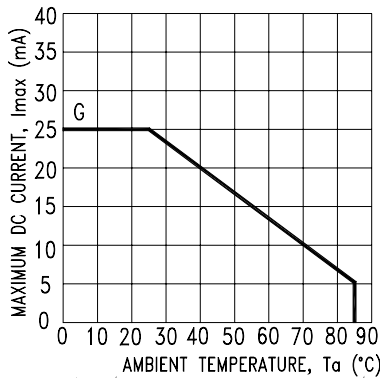
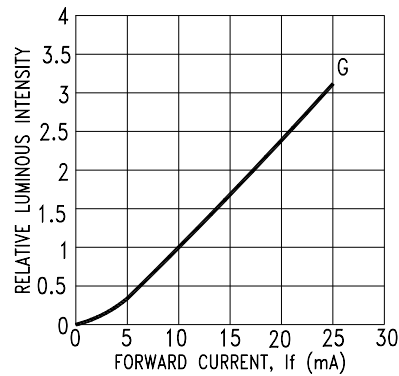
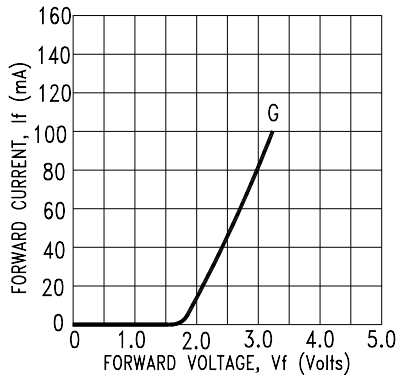
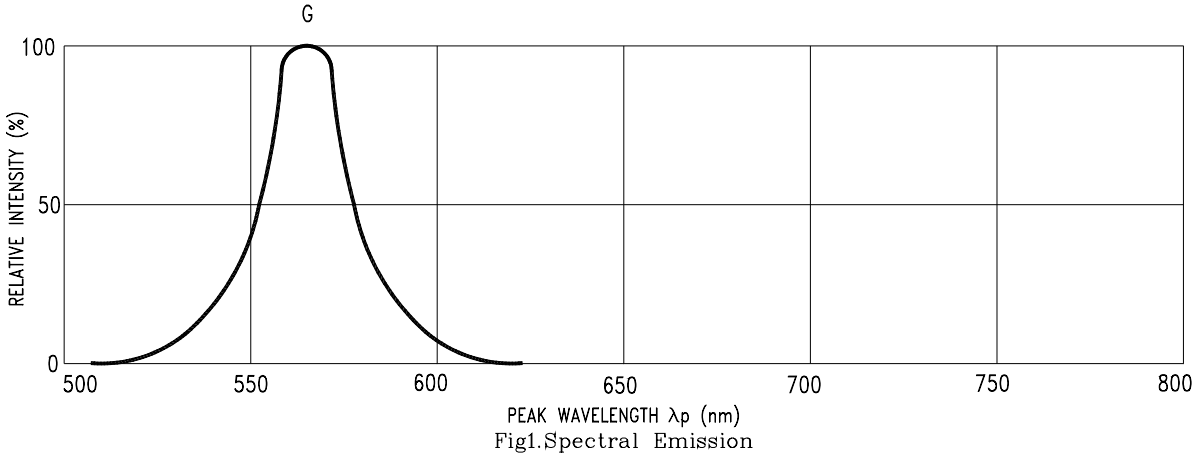

NOTE: G=GREEN.