

HSDL - 4261

High-Power T-1 $\frac{3}{4}$ (5mm) AlGaAs Infrared (870nm) Lamp



Data Sheet



Description

The HSDL-4261 Infrared emitter was designed for applications that require high power, low forward voltage and high speed. It utilizes Aluminum Gallium Arsenide (AlGaAs) LED technology and is optimized for speed and efficiency at emission wavelengths of 870nm. The material used produces high radiant efficiency over a wide range of currents. The emitter is packaged in clear T-1 $\frac{3}{4}$ (5mm) package.

Features

- Very High Power AlGaAs LED Technology
- 870nm Wavelength
- T-1 $\frac{3}{4}$ Package
- Low Cost
- Low Forward Voltage: 1.4V at 20mA
- High Speed: 15ns Rise Times

Applications

- Industrial IR Equipments
- IR Portable Instruments
- Consumer Electronics (Optical mouse etc)
- High Speed IR Communications (IR LANs, IR Modems, IR Dongles etc)
- IR Audio
- IR Telephones

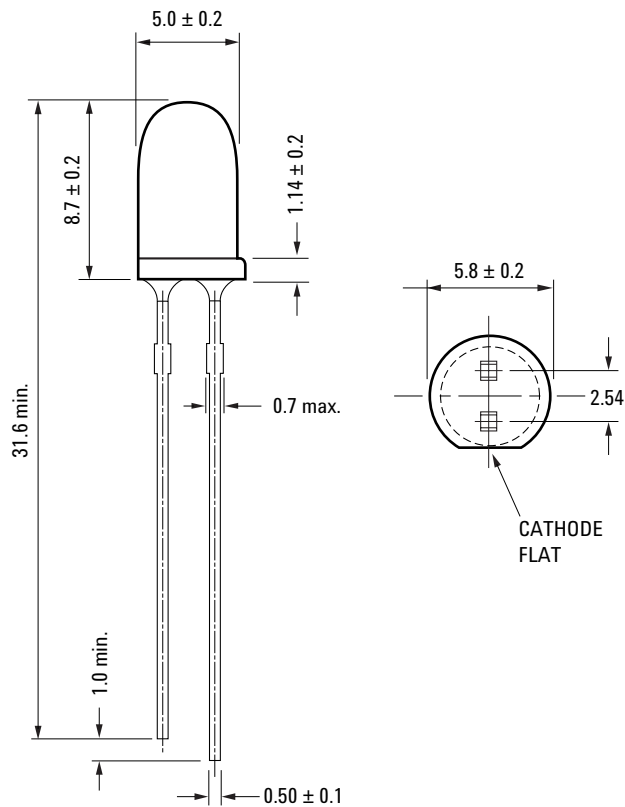

	Lead Form	Shipping Option
HSDL-4261	Straight	Bulk

Absolute Maximum Ratings at 25°C

Parameter	Symbol	Min.	Max	Unit	Reference
DC Forward Current	I _{FDC}	-	100	mA	[1], Fig. 2
Power Dissipation	P _{DISS}	-	190	mW	
Reverse Voltage	V _R	5	-	V	
Operating Temperature	T _O	-40	70	°C	
Storage Temperature	T _S	-40	100	°C	
LED Junction Temperature	T _J	-	110	°C	
Lead Soldering Temperature		-	260 for 5 sec	°C	

Notes:

1. Derate as shown in Figure 6.

Electrical Characteristics at 25°C

Parameter	Symbol	Min.	Typ.	Max.	Unit	Condition	Reference
Forward Voltage	V _F	-	1.4 1.7	1.5 1.9	V	I _{FDC} =20mA I _{FDC} =100mA	Fig. 2 Fig. 3
Forward Voltage Temperature Coefficient	DV/DT	-	-1.5 -1.3	-	mV/°C	I _{FDC} =20mA I _{FDC} =100mA	Fig. 4
Series Resistance	R _S	-	4.1	-	Ohms	I _{FDC} =100mA	
Diode Capacitance	C _O	-	80	-	pF	0V, 1MHz	
Reverse Voltage	V _R	3	14	-	V	I _R =100uA	
Thermal Resistance, Junction to Ambient	R _{qja}	-	280	-	°C/W		

Optical Characteristics at 25°C

Parameter	Symbol	Min.	Typ.	Max.	Unit	Condition	Reference
Radiant Optical Power	P _O	-	9 45	-	mW	I _{FDC} =20mA I _{FDC} =100mA	
Radiant On-Axis Intensity	I _E	-	36 180	-	mW/Sr	I _{FDC} =20mA I _{FDC} =100mA	Fig. 5
Radiant On-Axis Intensity Temperature Coefficient	DI _E /DT	-	-0.22	-	%/°C	I _{FDC} =100mA	
Viewing Angle	2q _{1/2}	-	26	-	deg	I _{FDC} =20mA	Fig. 7
Peak wavelength	I _{PK}	-	870	-	nm	I _{FDC} =20mA	Fig. 1
Peak wavelength Temperature Coefficient	DI/DT	-	0.18	-	nm/°C	I _{FDC} =20mA	
Spectral Width	DI	-	47 52	-	nm	I _{FDC} =20mA I _{FDC} =100mA	Fig. 1
Optical Rise and Fall Time	t _r /t _f	-	15	-	ns	I _{FPK} =500mA	
Bandwidth	f _c	-	23	-	MHz	Duty Factor=33% Pulse Width=125ns	

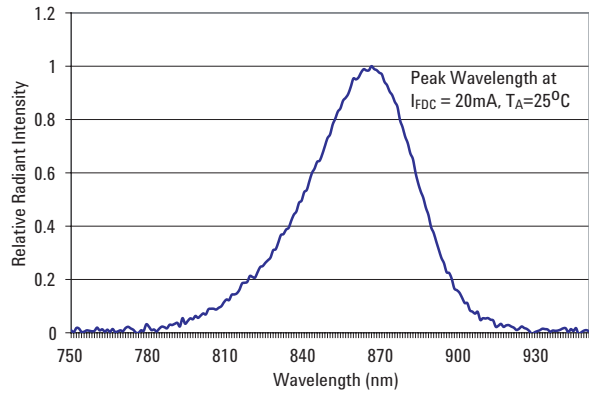

Figure 1. Relative Radiant Intensity vs. Wavelength

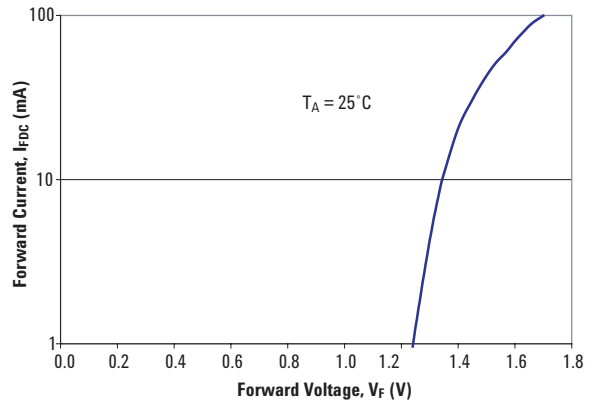

Figure 2. DC Forward Current vs. Forward Voltage

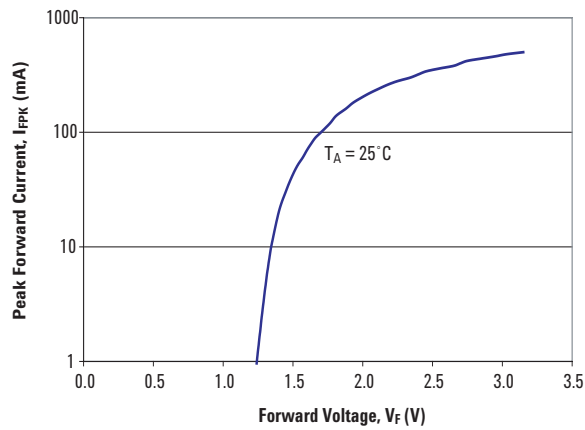

Figure 3. Peak Forward Current vs. Forward Voltage

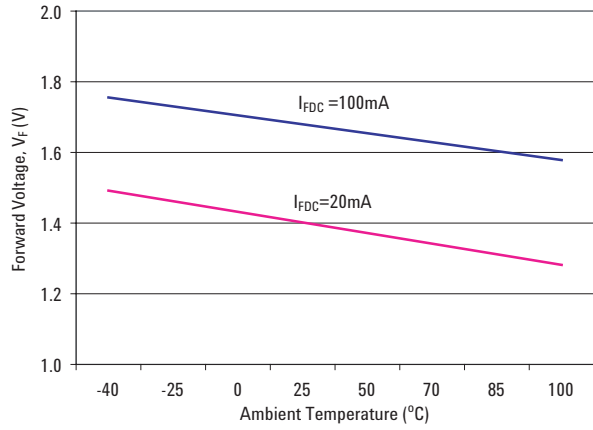

Figure 4. Forward Voltage vs. Ambient Temperature

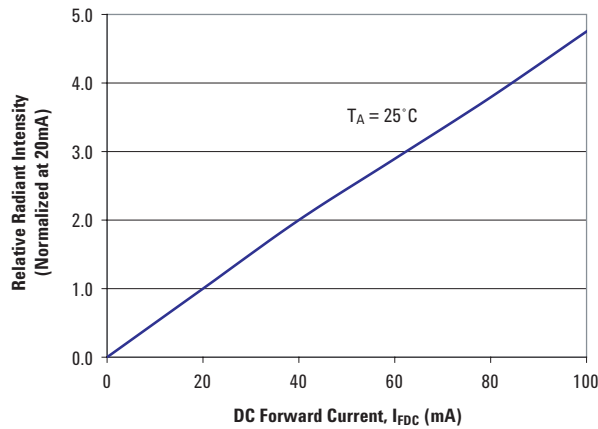

Figure 5. Relative Radiant Intensity vs. DC Forward Current

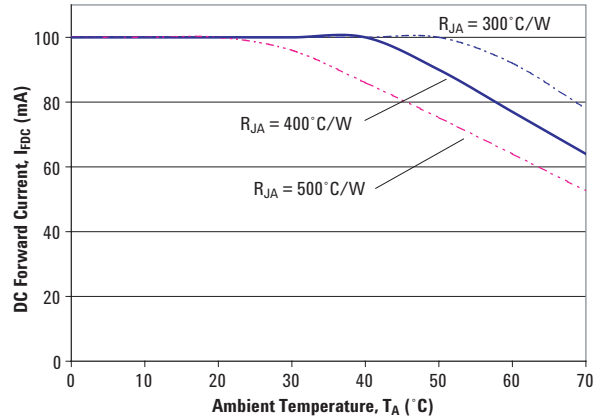

Figure 6. DC Forward Current vs. Ambient Temperature
Derated Based on $T_{JMAX}=110^{\circ}\text{C}$

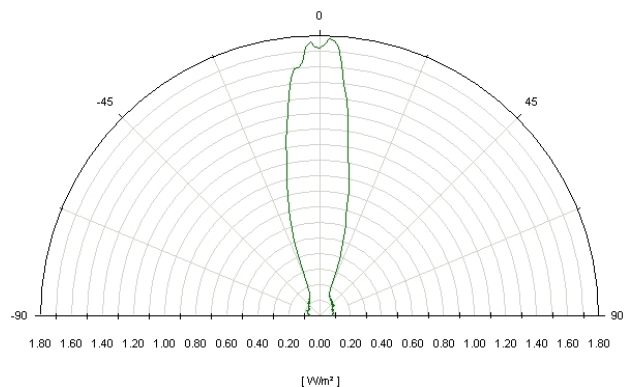

Figure 7. Radiant Intensity vs. Angular Displacement

For company and product information, please go to our web site: [WWW.liteon.com](http://www.liteon.com) or <http://optodatabook.liteon.com/databook/databook.aspx>

Data subject to change. Copyright © 2007 Lite-On Technology Corporation. All rights reserved.

